



www.DataSheet4U.com

15.0" XGA Color TFT-LCD Module
Model Name: L150X1M-1

() Preliminary Specifications
(◆) Final Specifications

i Contents

1.0 Handling Precautions

2.0 General Description

- 2.1 Display Characteristics
- 2.2 Functional Block Diagram
- 2.3 Optical Characteristics
- 2.4 Pixel format image

3.0 Electrical characteristics

- 3.1 Absolute Maximum Ratings
- 3.2 Module Interface Connectors
 - 3.2.1 Connector Type
 - 3.2.2 Pin Configuration
- 3.3 Backlight Connector
 - 3.3.1 Connector Type
 - 3.3.2 Pin Configuration
- 3.4 Signal Electrical Characteristics
- 3.5 Interface Timing
 - 3.5.1 Timing Characteristic
 - 3.5.2 Timing Definition
- 3.6 Power Consumption
- 3.7 Power ON/OFF Sequence

4.0 Backlight Characteristics

- 4.1 Signal for Lamp connector
- 4.2 Parameter guideline for CCFL Inverter

5.0 Label, Vibration, Shock, and Drop

- 5.1 Label
- 5.2 Vibration and shock
- 5.3 Drop test

6.0 Environment

- 6.1 Temperature and humidity
 - 6.1.1 Operating conditions
 - 6.1.2 Shipping conditions
- 6.2 Atmospheric pressure
- 6.3 Thermal shock

7.0 Reliability

- 7.1 Failure criteria
- 7.2 Failure rate
 - 7.2.1 Usage
 - 7.2.2 Components de-rating
- 7.3 CCFL life
- 7.4 ON/OFF cycle

8.0 Safety

(C) Copyright Acer Display Technology, Inc.

Nov, 2000 All Rights Reserved.

L150X1M-1 Ver0.6

2/25

No Reproduction and Redistribution Allowed.

www.DataSheet4U.com

- 8.1 Sharp edge requirement
- 8.2 Material
 - 8.2.1 Toxicity
 - 8.2.2 Flammability
- 8.3 Capacitors
- 8.4 Hazardous voltage

9.0 Other requirements

- 9.1 Smoke free design
- 9.2 National test lab requirement

10.0 Mechanical Characteristics

www.DataSheet4U.com

ii Record of Revision

Version and Date	Page	Old description	New Description	Remark
0.1 2000/07/28	All	First Edition for Customer	All	
0.2 2000/08/15	5	Brightness variation 15%(max.)	Brightness uniformity 85%(typ.)	Change
	5	Luminance uniformity 1.25(max.)	Luminance uniformity (TCO99) 1.7 (max.)	Change
	5	Color Gamut 62% typ., 60% min of NTSC coverage	Color Gamut 62% (typ.)	Change
	6	Note 2: Brightness variation ...	Note 2: Brightness uniformity of these 9 points is defined as follow: (Min. brightness / Max. brightness) x 100%	Change
	10	Storage humidity max. 100%	Storage humidity max. 95%	Change
	19	7.4 on/off cycle value 24,000	7.4 on/off cycle value 36,000	Change
	22,23		Mechanical characteristics update	Change
0.3 2000/08/31	5	Viewing angle 60(up),40(down)	Viewing angle 40(up),60(down)	Change
	8	Viewing angle (Upper) 60, (Lower) 40	Viewing angle (Upper) 40, (Lower) 60	Change
	22,23		Mechanical characteristics update	Change
0.4 2000/10/23	5,8	Brightness Uniformity : 85%(typ) / 80%(min)	Brightness Uniformity : 80%(typ) / 75%(min)	Change
0.5 2000/11/16	8		Viewing Angle (min) : 50/50/30/50(L/R/U/D) Color / Chromaticity : Wx = 0.313 ± 0.03 Wy = 0.329 ± 0.03 Rx = 0.633 ± 0.03 Ry = 0.336 ± 0.03 Gx = 0.294 ± 0.03 Gy = 0.604 ± 0.03	Change

			Bx = 0.145 ± 0.03 By = 0.097 ± 0.03 CCFL frequency : 50kHz (typ)	
0.6	2000/11/28	6,8	Contrast Ratio : 300(min), 400(typ) Response Time : Ton (max) : 22ms Toff(max) : 48ms Ton+Toff(max) : 70ms	Change
		15	LCD Drive current:600mA(typ) LCD Drive Power consumption : 2W (typ)	Change
		23,24	Adding one boss to the back plate	Change
		16	CCFL Power Consumption : 16W	Change

1.0 Handling Precautions

- 1) Since front polarizer is easily damaged, pay attention not to scratch it.
- 2) Be sure to turn off power supply when inserting or disconnecting from input connector.
- 3) Wipe off water drop immediately. Long contact with water may cause discoloration or spots.
- 4) When the panel surface is soiled, wipe it with absorbent cotton or other soft cloth.
- 5) Since the panel is made of glass, it may break or crack if dropped or bumped on hard surface.
- 6) Since CMOS LSI is used in this module, take care of static electricity and insure human earth when handling.
- 7) Do not open nor modify the Module Assembly.
- 8) Do not press the reflector sheet at the back of the module to any directions.
- 9) At the insertion or removal of the Signal Interface Connector, be sure not to rotate nor tilt the Interface Connector of the TFT-LCD module.
- 10) After installation of the TFT-LCD module into an enclosure (LCD monitor housing, for example), do not twist nor bend the TFT-LCD Module even momentary. At designing the enclosure, it should be taken into consideration that no bending/twisting forces are applied to the TFT-LCD module from outside. Otherwise the TFT-LCD module may be damaged.

2.0 General Description

This specification applies to the 15.0 inch Color TFT-LCD Module L150X1M-1.

The display supports the XGA (1024(H) x 768(V)) screen format and 16.7M colors (RGB 8-bits data).

All input signals are 2 Channel TTL interface compatible.

This module does not contain an inverter card for backlight.

2.1 Display Characteristics

The following items are characteristics summary on the table under 25 °C condition:

ITEMS	Unit	SPECIFICATIONS
Screen diagonal	[mm]	381 (15")
Outline dimension	[mm]	352.5 x 263.5 x 16 (typ.)
Display Area	[mm]	304.128 (H) x 228.096(V)
Resolution		1024(R,G,B x 3) x 768
Pixel Pitch	[mm]	0.297 x 0.297
Pixel Arrangement		R.G.B. Vertical Stripe
Display Mode		TN mode, Normally White
Average brightness	[cd/m ²]	250 (typ.) (note 1)
Brightness uniformity		80% (typ.) (note 2)
Luminance uniformity (TCO99)		1.7 (max.) (note 3)
Crosstalk		1.2% (max.) (note 4)
Contrast Ratio		400 : 1 (typ.)
Support color		Native 16.7 million(8-bit for R,G,B)
Color Gamut		62% (typ.)
Viewing angle		60(left),60(right), 40(up), 60(down)
Response Time	[msec]	35 (typ.)(Tr +Tf)
Nominal Input Voltage VDD	[Volt]	+3.3 V
Power Consumption (VDD line + CCFL line)	[Watt]	15 (typ.)
Electrical Interface		TTL 2 port (HSYNC, VSYNC, DCLK, DE, DATA)
Frame rate	[Hz]	60 (typ), 75 (max.)
Weight	[Grams]	1400 (typ.)
Temperature Range		
Operating	[°C]	0 to +50
Storage (Shipping)	[°C]	-20 to +60

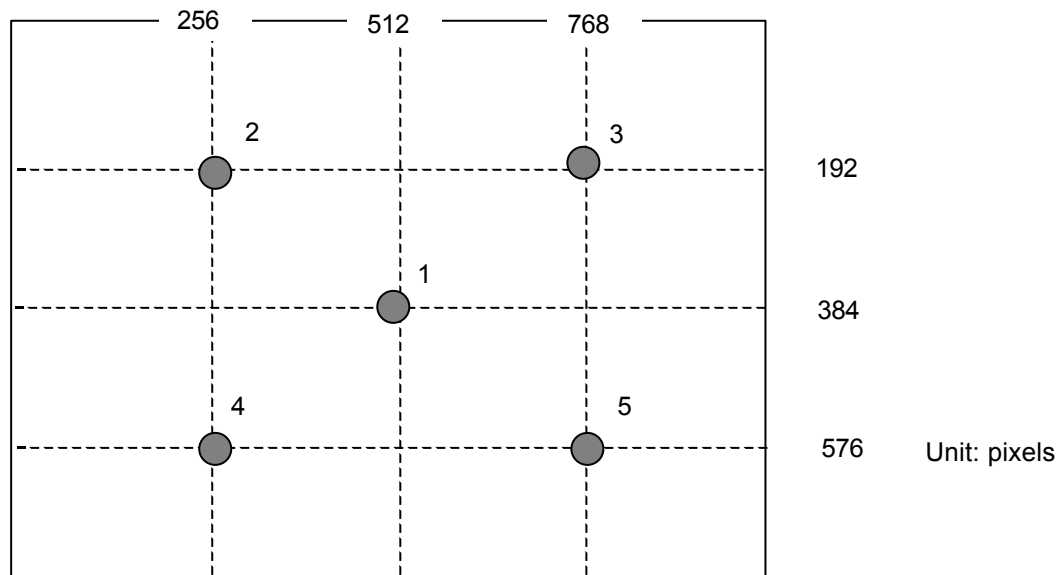

Note 1: Average brightness is the average of brightness value at location 1 to 5 with all pixels displaying white.

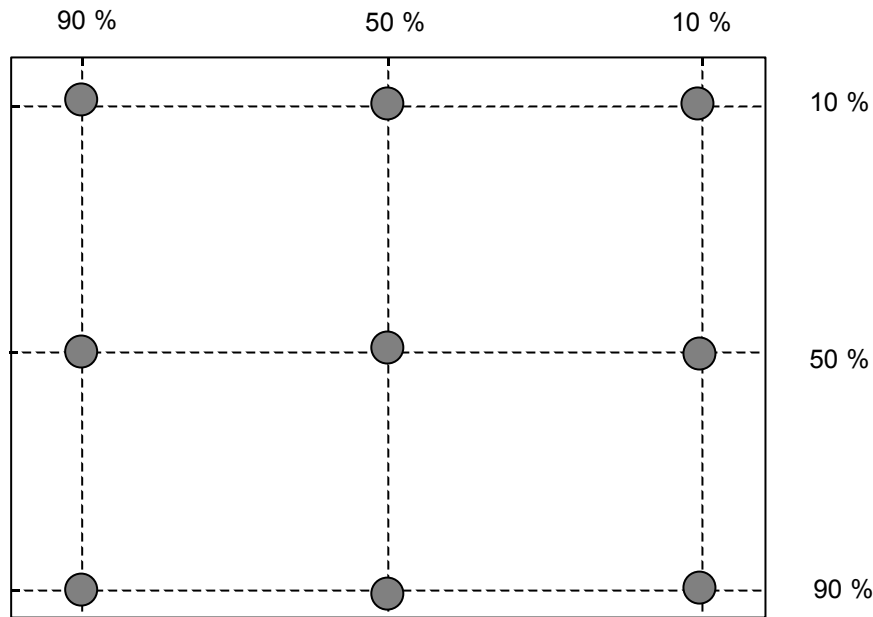

Unit: percentage of dimension of display area

Note 2: Brightness uniformity of these 9 points is defined as below:

$$(\text{Min. brightness} / \text{Max. brightness}) \times 100\%$$

Note 3: TCO '99 Certification Requirements and test methods for environmental labeling of Display Report No. 2 defines Luminance uniformity as below:

$$((L_{\text{max},+30\text{deg.}} / L_{\text{min},+30\text{deg.}}) + (L_{\text{max},-30\text{deg.}} / L_{\text{min},-30\text{deg.}})) / 2$$

Note 4:

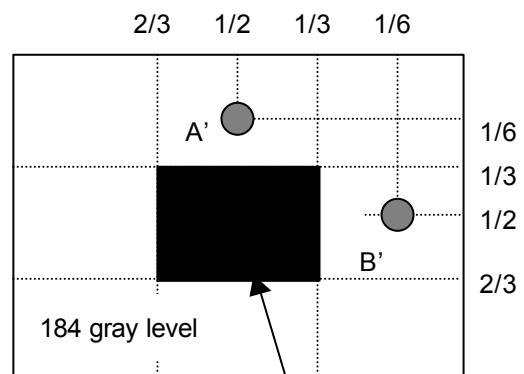
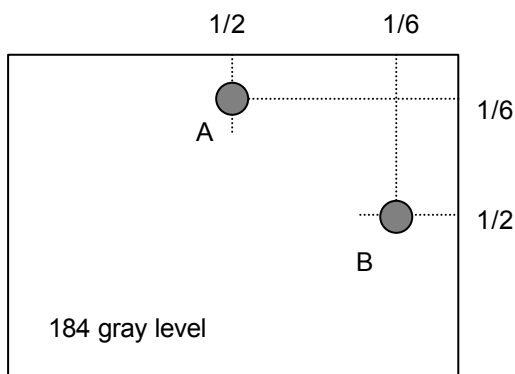

Unit: percentage of dimension of display area

$$|L_A - L_{A'}| / L_A \times 100\% = 1.2\% \text{ max.}, L_A \text{ and } L_B \text{ are brightness at location A and B}$$

$$|L_B - L_{B'}| / L_B \times 100\% = 1.2\% \text{ max.}, L_{A'} \text{ and } L_{B'} \text{ are brightness at location A' and B'}$$

(C) Copyright Acer Display Technology, Inc.

Nov, 2000 All Rights Reserved.

L150X1M-1 Ver0.6

7/25

No Reproduction and Redistribution Allowed.

www.DataSheet4U.com

2.2 Functional Block Diagram

The following diagram shows the functional block of 15.0 inches Color TFT-LCD Module:

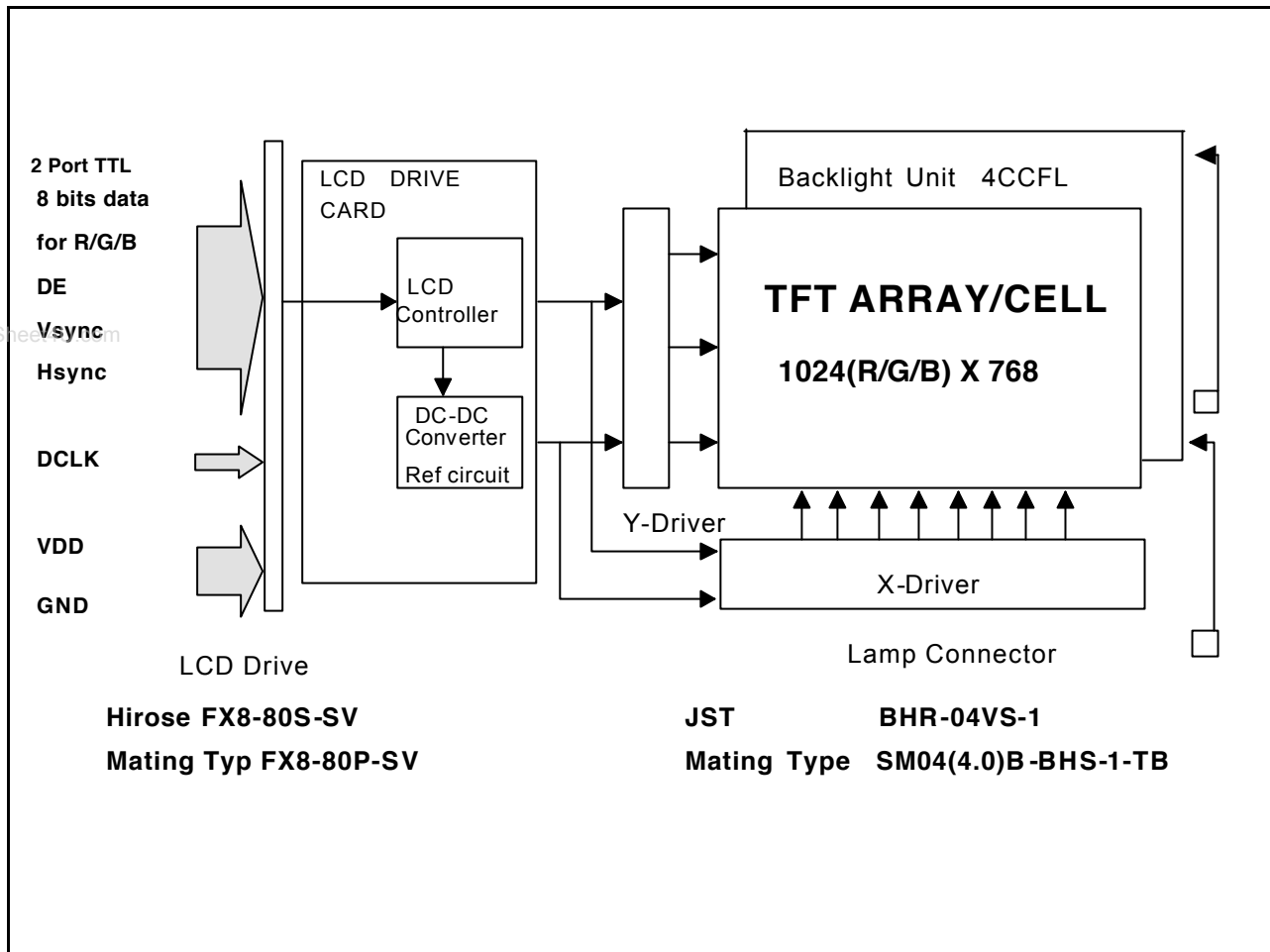

2.3 Optical Characteristics

The optical characteristics are measured under stable conditions at 25°C (Room Temperature):

Item	Unit	Conditions	Min.	Typ.	Max.
Viewing Angle	[degree]	Horizontal (Right)	50	60	
	[degree]	CR = 10 (Left)	50	60	
CR: Contrast Ratio	[degree]	Vertical (Up)	30	40	
	[degree]	CR = 10 (Down)	50	60	
Contrast ratio		Normal Direction	300	400	-
Response Time	[msec]	Raising Time Ton (10%-90%)	-	11	22
	[msec]	Falling Time Toff (90%-10%)	-	24	48
	[msec]	Raising + Falling	-	35	70
Color / Chromaticity Coordinates (CIE)		Red x	0.603	0.633	0.663
		Red y	0.306	0.336	0.366
		Green x	0.264	0.294	0.324
		Green y	0.574	0.604	0.634
		Blue x	0.115	0.145	0.175
		Blue y	0.067	0.097	0.127
Color Coordinates (CIE) White		White x	0.283	0.313	0.343
		White y	0.299	0.329	0.359
Brightness Uniformity	[%]		75	80	-
White Luminance at CCFL 5.5mA (center point)	[cd/m ²]		200	250	-

3.0 Electrical characteristics

3.1 Absolute Maximum Ratings

Absolute maximum ratings of the module is as following:

Item	Symbol	Min	Max	Unit	Conditions
Logic/LCD Drive Voltage	VDD	-0.3	+4.0	[Volt]	
CCFL Inrush current	ICFLL	-	20	[mA]	Note 1
CCFL Current	ICFL	-	7.5	[mA] rms	
Operating Temperature	TOP	0	+50	[°C]	Note 2
Operating Humidity	HOP	20	85	[%RH]	Note 2
Storage Temperature	TST	-20	+60	[°C]	Note 2
Storage Humidity	HST	5	95	[%RH]	Note 2

Note 1 : Duration=50 msec

Note 2 : Maximum Wet-Bulb should be 39°C and No condensation.

3.2 Module Interface Connectors

3.2.1 Connector type

Connector Name	Interface Connector
Manufacturer	Hirose or compatible
Type / Part Number	FX8-80S-SV
Mating Housing/Part Number	FX8-80P-SV

3.2.2 Pin Configuration

Pin No.	Symbol	Description	Pin No.	Symbol	Description
1	GND	ground	41	GND	Ground
2	RO0	Red data 0(odd),LSB	42	GE0	Green data 0(even),LSB
3	RO1	Red data 1(odd)	43	GE1	Green data 1(even)
4	RO2	Red data 2(odd)	44	GE2	Green data 2(even)
5	RO3	Red data 3(odd)	45	GE3	Green data 3(even)
6	GND	Ground	46	GND	Ground
7	RO4	Red data 4(odd)	47	GE4	Green data 4(even)
8	RO5	Red data 5(odd)	48	GE5	Green data 5(even)

9	RO6	Red data 6(odd)	49	GE6	Green data 6(even)
10	RO7	Red data 7(odd),MSB	50	GE7	Green data 7(even),MSB
11	GND	Ground	51	GND	Ground
12	GO0	Green data 0(odd),LSB	52	BE0	Blue data 0(even),LSB
13	GO1	Green data 1(odd)	53	BE1	Blue data 1(even)
14	GO2	Green data 2(odd)	54	BE2	Blue data 2(even)
15	GO3	Green data 3(odd)	55	BE3	Blue data 3(even)
16	GND	Ground	56	GND	Ground
17	GO4	Green data 4(odd)	57	BE4	Blue data 4(even)
18	GO5	Green data 5(odd)	58	BE5	Blue data 5(even)
19	GO6	Green data 6(odd)	59	BE6	Blue data 6(even)
20	GO7	Green data 7(odd),MSB	60	BE7	Blue data 7(even),MSB
21	GND	Ground	61	GND	Ground
22	BO0	Blue data 0(odd),LSB	62	GND	Ground
23	BO1	Blue data 1(odd)	63	DCLK	Data input clock
24	BO2	Blue data 2(odd)	64	GND	Ground
25	BO3	Blue data 3(odd)	65	GND	Ground
26	GND	Ground	66	HSYNC	Horizontal sync signal
27	BO4	Blue data 4(odd)	67	GND	Ground
28	BO5	Blue data 5(odd)	68	GND	Ground
29	BO6	Blue data 6(odd)	69	DE	Data enable signal
30	BO7	Blue data 7(odd),MSB	70	VSYNC	Vertical sync signal
31	GND	Ground	71	VDD	Power supply +3.3V
32	RE0	Red data 0(even),LSB	72	VDD	Power supply +3.3V
33	RE1	Red data 1(even)	73	VDD	Power supply +3.3V
34	RE2	Red data 2(even)	74	VDD	Power supply +3.3V
35	RE3	Red data 3(even)	75	VDD	Power supply +3.3V
36	GND	Ground	76	NC	No connection
37	RE4	Red data 4(even)	77	NC	No connection
38	RE5	Red data 5(even)	78	Reserved	Reserved for MFG test
39	RE6	Red data 6(even)	79	NC	No connection
40	RE7	Red data 7(even),MSB	80	GND	Ground

3.3 Backlight Connectors

3.3.1 Connector type

Connector Name / Designation	For Lamp Connector
-------------------------------------	--------------------

Manufacturer	JST or compatible
Type / Part Number	BHR-04VS-1
Mating Type / Part Number	SM04(4.0)B-BHS-1-TB

3.3.2 Pin Configuration

Pin	Symbol	Description
1	HV	Lamp High Voltage
2	LV	Lamp Low Voltage
3	NC	No connection
4	GND	Ground

3.4 Signal Electrical Characteristics

Each signal characteristics are as follows;

Item	Symbol	Min	Typ	Max	Unit
LCD Drive voltage	VDD	+3.0	+3.3	+3.6	[V]
“High” input signal voltage	Vih	2.0	-	-	[V]
“Low” input signal voltage	Vil	-	-	0.8	[V]

3.5 Interface Timings

3.5.1 Timing Characteristics

Signal	Item	Symbol	MIN	TYP	MAX	Unit
DCLK	Frequency	1/TDCLK	-	32.5	40.0	MHz
	Period	TDCLK	25	30.8	-	ns
	High time	TCH	0.4	0.5	0.6	TDCLK
	Low time	TCL	0.4	0.5	0.6	TDCLK
DATA	Setup time	TDS	5	-	-	ns
	Hold time	TDH	5	-	-	ns
Data Enable	Setup time	TES	5	-	-	ns
	Hold time	TEH	5	-	-	ns
Horizontal sync	Frequency	1/TH	-	48	60	KHz
	Pulse width	THP	2	68	-	TDCLK
Horizontal Signal	Back –porch	THB	1	80	-	TDCLK
	Display period	THD	512	512	512	TDCLK
	Front-porch	THF	0	12	-	TDCLK
Vertical sync	Frequency	1/TV	-	60	75	Hz
	Pulse width	TVP	1	6	-	TH
Vertical Signal	Back –porch	TVB	7	29	64	TH
	Display period	TVD	768	768	768	TH
	Front-porch	TVF	1	3	-	TH

3.5.2 Timing Definition

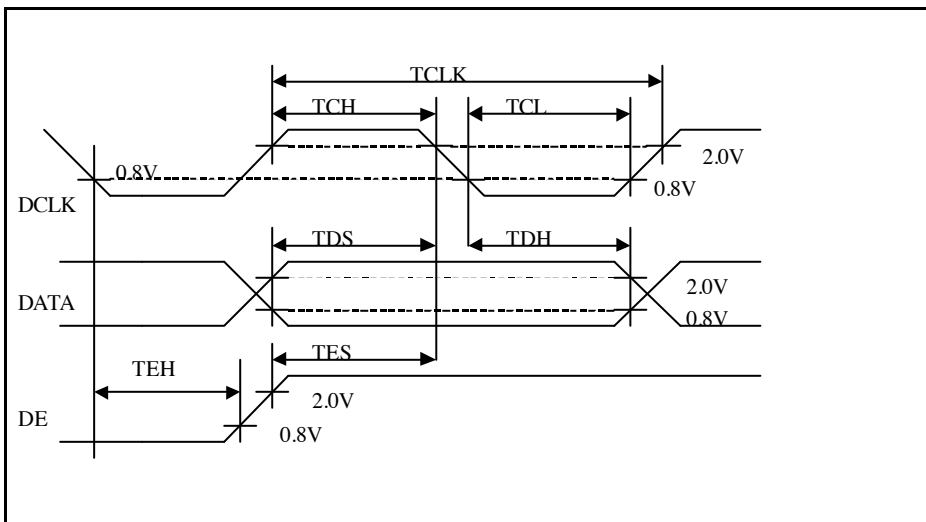
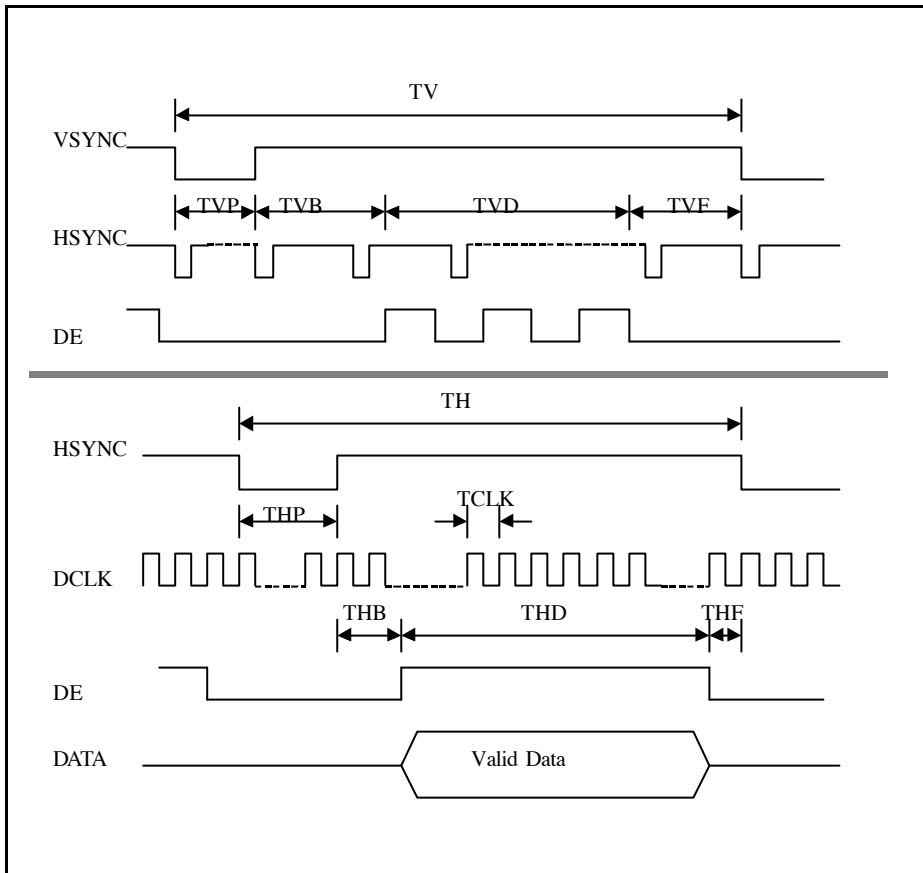

3.6 Power Consumption

Input power specifications are as follows;

Symbol	Parameter	Min	Typ	Max	Units	Condition
VDD	LCD Drive Voltage	3.0	3.3	3.6	[V]	
IDD	LCD Drive Current	-	600	tbd	[mA]	VDD=3.3v, All Black Pattern
PDD	LCD Drive power consumption	-	2.0	tbd	[Watt]	VDD=3.3v, All Black Pattern
VDDrp	Allowable LCD Drive Ripple Voltage			100	[mV] p-p	
VDDns	Allowable LCD Drive Ripple Noise			100	[mV] p-p	

3.7 Power ON/OFF Sequence

VDD power and lamp on/off sequence is as follows. Interface signals are also shown in the chart.

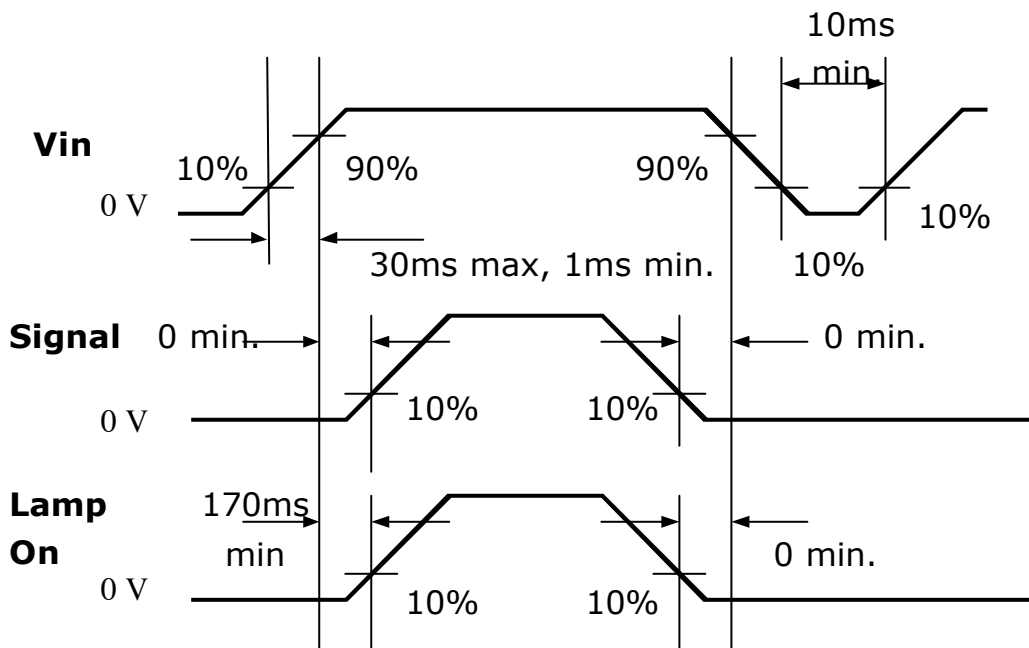

4.0 Backlight Characteristics

4.1 Signal for Lamp connector

Pin #	signal Name
1	Lamp High Voltage
2	Lamp High Voltage
3	No Connection
4	Ground

4.2 Parameter guide line for CCFL Inverter

Symble	Parameter	Min	Typ	Max	Units	Condition
(L255)	White Luminance	200	250	-	[cd/m ²]	(Ta=25°C)
ISCFL	CCFL standard current	5.0	5.5	6.0	[mA] rms	(Ta=25°C)
IRCFL	CCFL operation range	Tbd	Tbd	Tbd	[mA] rms	(Ta=25°C)
ICFL	CCFL Inrush current	-	-	20	[mA]	Note 1
fCFL	CCFL Frequency	40	50	60	[KHz]	(Ta=25°C) Note 2
ViCFL (0°C)	CCFL Ignition Voltage			1350	[Volt] rms	(Ta= 0°C) Note 4
ViCFL (25°C) (reference)	CCFL Ignition Voltage			tbd	[Volt] rms	(Ta= 25°C) Note 4
VCFL	CCFL Discharge Voltage (Reference)		660	tbd	[Volt] rms	(Ta=25°C) Note 3
PCFL	CCFL Power consumption		16	tbd	[Watt]	(Ta=25°C) Note 3

Note 1: Duration=50 [msec]

Note 2: CCFL Frequency should be carefully determined to avoid interference between inverter and TFT LCD

Note 3: Calculator value for reference (ICFL×VCFL=PCFL)

Note 4: CCFL inverter should be able to give out a power that has a generating capacity of over 1350 voltage.
Lamp units need 1350 voltage minimum for ignition

5.0 Label, Vibration, Shock, and Drop

5.1 Label

Unit mark is printed on a label. The label is shown as below:

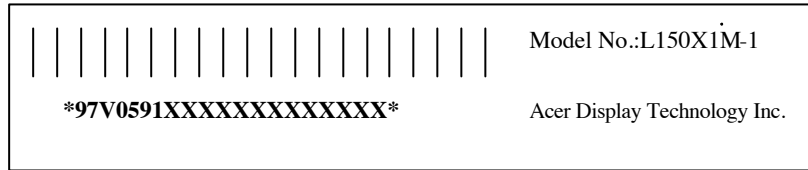

Model No: L150X1M-1

www.DataSheet4U.com

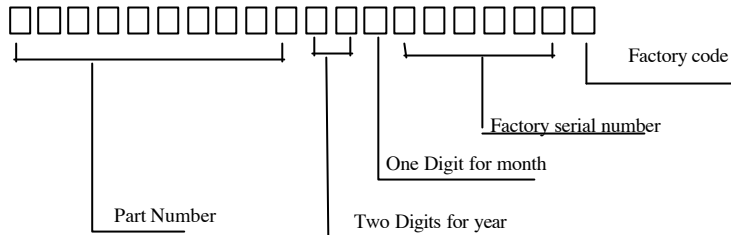

Serial No:

Factory Code: H: HsinChu

Year	Mark
1997	97
1998	98
1999	99
2000	00
2001	01
2002	02

Month	Mark	Month	Mark
1	1	7	7
2	2	8	8
3	3	9	9
4	4	10	A
5	5	11	B
6	6	12	C

CARTON NO:

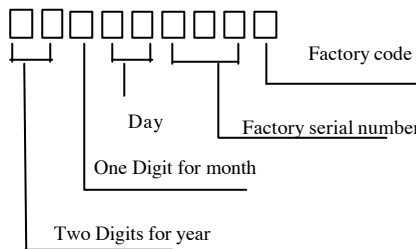

5.2 Vibration & Shock

The module shall work error free after following vibration and shock condition. Likewise the module shall not sustain any damage after vibration and shock test.

5.2.1 Vibration Test Spec:

- Frequency: 10 - 200Hz
- Sweep: 30 Minutes each Axis (X, Y, Z)
- Acceleration: 1.5G(10~200Hz P- P)

www.DataSheet4U.com Test method:

Acceleration (G)	1.5
Frequency (Hz)	10~200~10
Active time(min)	30

5.2.2 Shock Test Spec:

Acceleration (G) -a	50
Active time(ms) -b	20
Wave form	half-sin
Times	1

- Direction: $\pm X$, $\pm Y$, $\pm Z$

5.3 Drop

Package test: The drop height is defined as 60 cm.

6.0 Environment

The display module will meet the provision of this specification during operating condition or after storage or shipment condition specified below. Operation at 10% beyond the specified range will not cause physical damage to the unit.

6.1 Temperature and Humidity

6.1.1 Operating Conditions

The display module operates error free, when operated under the following conditions;

Temperature	0 °C to 50 °C
Relative Humidity	20% to 85%
Wet Bulb Temperature	39.0 °C

6.1.2 Shipping Conditions

The display module operates error free, after the following conditions;

Temperature	-20 °C to 60 °C
Relative Humidity	5% to 95%
Wet Bulb Temperature	39.0 °C

6.2 Atmospheric Pressure

The display assembly is capable of being operated without affecting its operations over the pressure range as following specified:

	Pressure	Altitude
Maximum Pressure	1040 hPa	0 m = sea level
Minimum Pressure	601 hPa	3658 m = 12,000 feet

Note: Non-operation altitude limit of this display module = 40,000 feet. = 12193 m.

6.3 Thermal Shock

The display module will not sustain damage after being subjected to 100 cycles of rapid temperature change. A cycle of rapid temperature change consists of varying the temperature from -20°C to 60°C, and back again.

Thermal shock cycle	-20 °C for 30min
	60 °C for 30min

Power is not applied during the test. After temperature cycling, the unit is placed in normal room ambient for at least 4 hours before powering on.

7.0 Reliability

This display module and the packaging of that will comply following standards.

7.1 Failure Criteria

The display assembly will be considered as failing unit when it no longer meets any of the requirements stated in this specification. Only as for maximum white luminance, following criteria is applicable.

- **Maximum white Luminance shall be 75 cd/m² or more.**

7.2 Failure Rate

The average failure rate of the display module (from first power-on cycle till 1,000 hours later) will not exceed 1.0%. The average failure rate of the display module from 1,000 hours until 10,000 hours will not exceed 0.70% per 1000 hours.

7.2.1 Usage

The assumed usage for the above criteria is:

- 220 power-on hours per month
- 500 power on/off cycles per month
- Maximum brightness setting
- Operation to be within office environment (25°C typical)

7.2.2 Component De-rating

All the components used in this device will be checked the load condition to meet the failure rate criteria.

7.3 CCFL Life

The assumed CCFL Life will be longer than 50,000 hours under stable condition at 25 ± 5 °C;

Standard current at 5.5 ± 0.5 mA

Definition of life: brightness becomes 50% or less than the minimum luminance value of CCFL.

7.4 ON/OFF Cycle

The display module will be capable of being operated over the following ON/OFF Cycles.

ON/OFF	Value	Cycle
+VDD and CCFL power	36,000	10 seconds on / 10 seconds off

8.0 Safety

8.1 Sharp Edge Requirements

There will be no sharp edges or corners on the display assembly that could cause injury.

8.2 Materials

8.2.1 Toxicity

There will be no carcinogenic materials used anywhere in the display module. If toxic materials are used, they will be reviewed and approved by the responsible ADT Toxicologist.

8.2.2 Flammability

All components including electrical components that do not meet the flammability grade UL94-V1 in the module will complete the flammability rating exception approval process. The printed circuit board will be made from material rated 94-V1 or better. The actual UL flammability rating will be printed on the printed circuit board.

8.3 Capacitors

If any polarized capacitors are used in the display assembly, provisions will be made to keep them from being inserted backwards.

8.4 Hazardous Voltages

Any point exceeding 42.4 volts meets the requirement of the limited current circuit. The current through a $2K\ \Omega$ resistance is less than $0.7 \times f$ (kHz) mA.

9.0 Other requirements

9.1 Smoke Free Design

By any single failure, any smoke nor strange smell shall not be observed by the operator.

9.2 National Test Lab Requirement

The display module will satisfy all requirements for compliance to the following requirement:

www.DataSheet4U.com

UL 1950, First Edition

U.S.A. Information Technology Equipment

CSA C222 No.950-M89

Canada, Information Technology Equipment

IEC 950

International, Information Technology Equipment

EN 60 950

International, Information Processing Equipment

(European Norm for IEC950)

The construction of the display module is designed to suppress EMI. When mounted into a specified host system, the system will meet the following EMI requirement:

FCC Part 15 Class B

VCCI Class 2

CISPR 22, class B

Taiwan CNS standard

China CCIB standard

10.0 Mechanical Characteristics

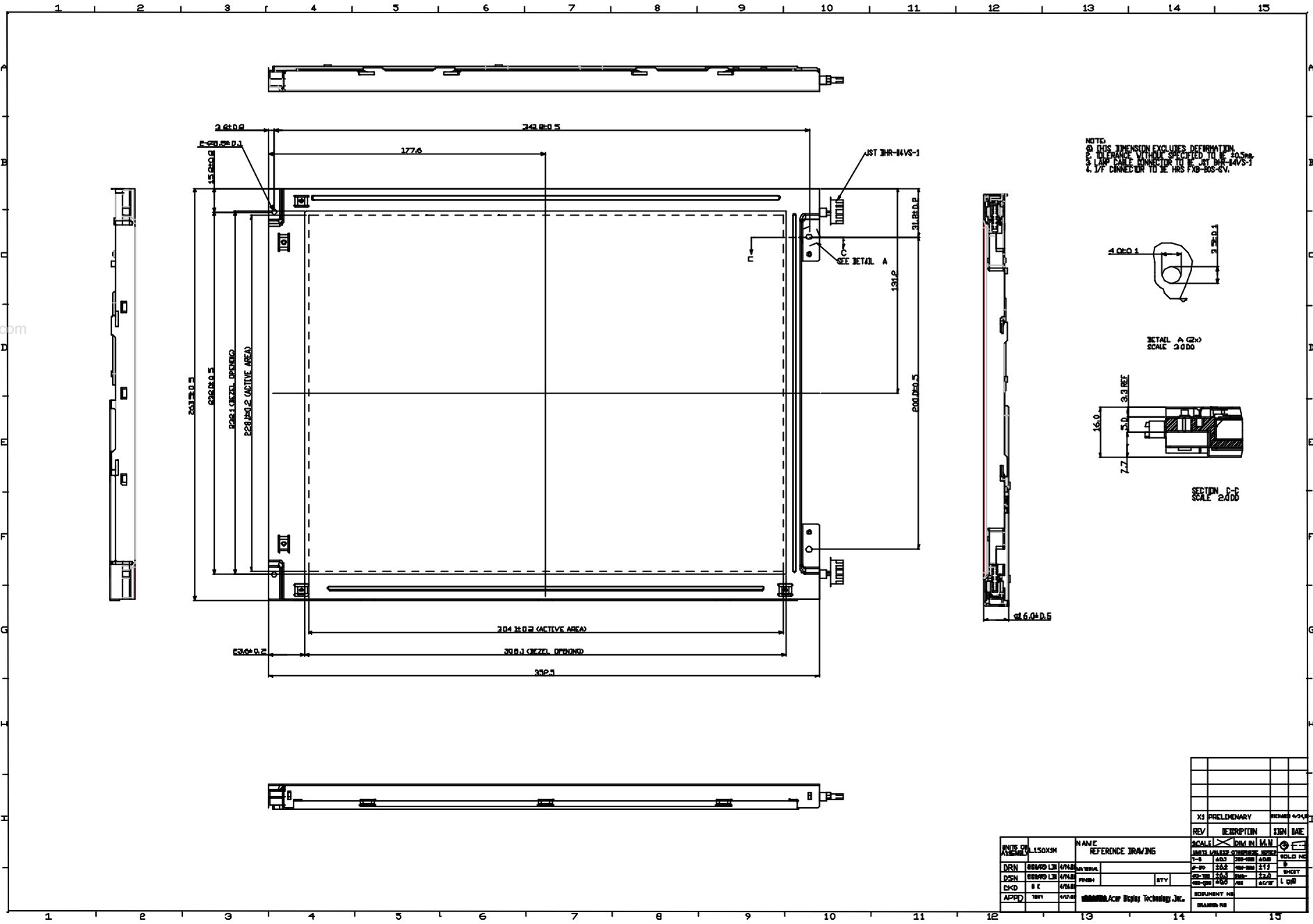

NOTE:
 1. THIS DIMENSION EXCLUDES DEFORMATION
 2. REFERENCE DRAWING SPECIFIED TO BE 2000
 3. IHR-14VS-1 MINIMUM TO BE IHR-14VS-1
 4. IHR-80S-SV MINIMUM TO BE IHR-80S-SV.

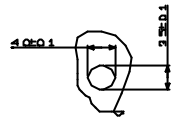

METAL A (20
 SCALE 2:000

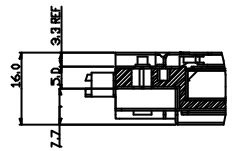

SECTION C-C
 SCALE 2:000

REV	DESCRIPTION	DATE	BY
X1	PRELIMINARY		

DATE OF ASSEMBLY	15/03/2018	NAME	REFERENCE DRAWING
DRN	15/03/2018	DESIGNER	
DSN	15/03/2018	DESIGNER	
CHKD	15/03/2018	DESIGNER	
APPRD	15/03/2018	DESIGNER	

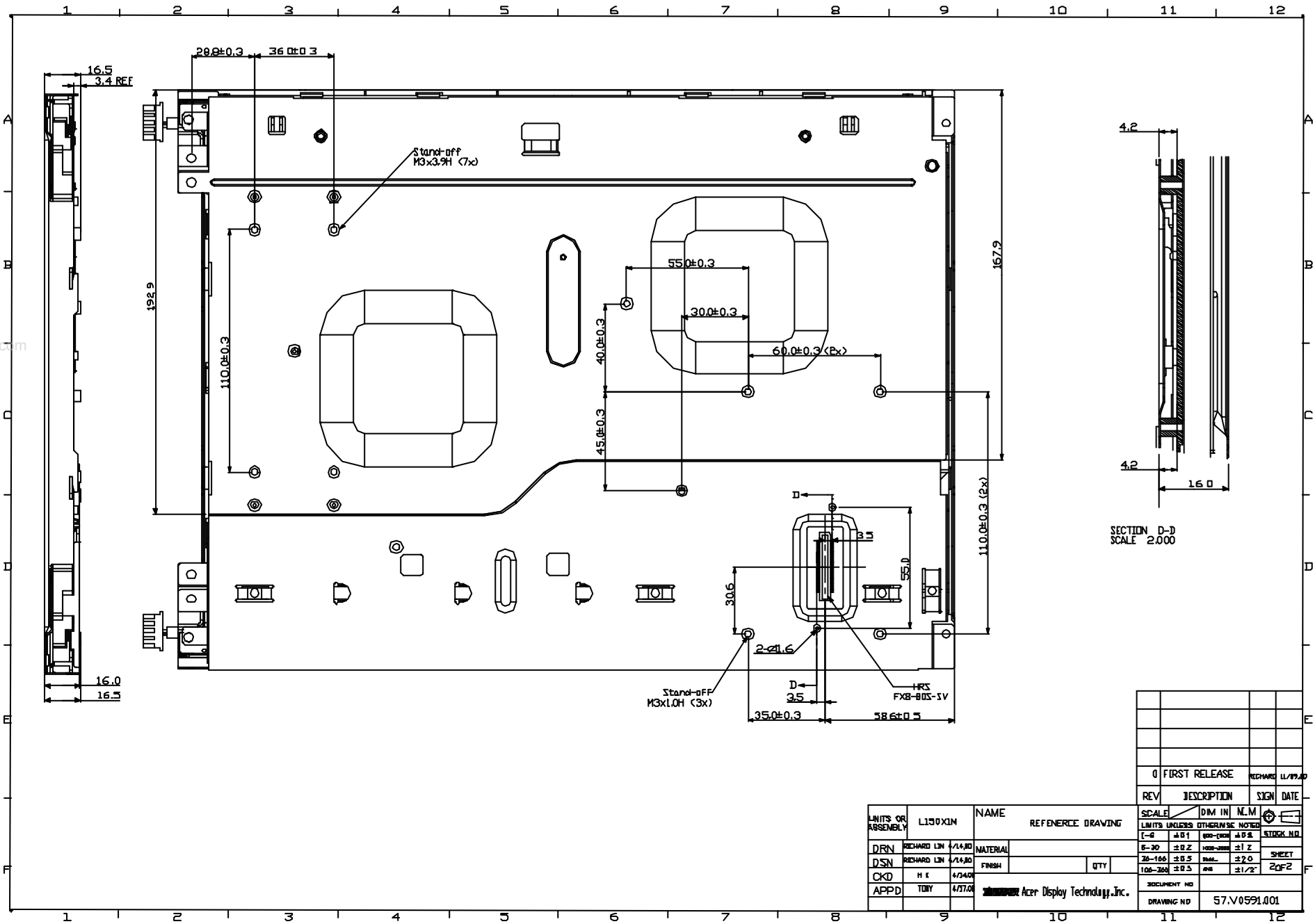

www.DataSheet4U.com

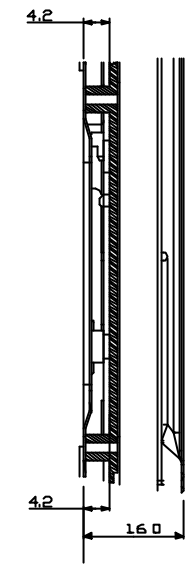

SECTION D-D
SCALE 2,000

REV	DESCRIPTION	SIGN	DATE
0	FIRST RELEASE	RICHARD	11/19/00

LIMITS OR ASSEMBLY	L130X1M	NAME	REFERENCE DRAWING
DRN	RICHARD LIN 4/14/00		
DSN	RICHARD LIN 4/14/00	MATERIAL	
CKD	H T 4/24/00	FINISH	QTY
APPD	TORY 4/27/00	Acip Display Technology, Inc.	

SCALE	DIM IN	N.M
1:1	1/8"	1/16"
2:1	1/4"	1/8"
5:1	3/8"	1/4"
10:1	1/2"	3/8"
20:1	3/4"	1/2"
50:1	1"	3/4"
100:1	1 1/4"	1"

We have lcd specifications below!

A				
A070FW01	AA084VB01	AA084VB02	AA104VA01	AA104VB02
AA104VB04	AA104VB2	AA121SK01	AA121SK02	AA121SK03
AA121SK04	AA121SK05	AA121SK12	AA142XC11	AA150XA01
AA150XA01B	AA150XA03	ALP022AGXB	ALP022AXX	ALP121AAX
ALP121AGX	ALP121AXX	ALP228CAXA	ALP228CGXC	ALP228CXX
ALP230CCX	ALP230CGX	ALP234FCX	ALP234FXX	ALP236FCX
ALP236FXX	ALP237FAX	ALP237FXX	ALP239CCX	ALP239CGX
ALP239CXX	ALR122FNX	ALR122FXX	AND10C209A-4HB	AND10C209A-DHB
AND10C209A-HB	AND10C273-4HB	AND10C273-DHB	AND10C273-HB	AND10C401S
AND12C275A-DHB	AND12C275A-HB	AND64C402V-HB	ANDPSI04C380K-HB	ANDpSi08C343S
ANDPSI08C351-HB	ANDpSi10C306L-HB	APAX T05U2	APAX T06U1	APAX T08U1
APAX T10U1	APAX T13A3	APAX T13A4	APAX T13U1	APL121AGX
AU L170E3 v0927				
C				
CO73B-HE	CO90A	C095A	C096A	CJM10C0101
CJM16C0101	CLAA141XC01	CLAA150XA03	CMJ10C101	
D				
D091201	DMC-20434	dmc40120	DMC40218	DMC40457NY-LY-B
DMF5000	DMF-50081ZNB-FW	DMF-50202N	DMF-50316NF-FW-1	
E				
ECM-A0557	EDMGRA8KAF	EDMGRB8KAF	EDMGRB9SCF	EDMGRC1KAF
EDMMPU3B4F	EDMMR04GOO	EDMMR04HOW	EDMMR63BOF	EDMMR63WOF
EDTCA07QDO	EDTCA07QEF	EDTCA08	EDTCA14QBO	EDTCA14QCF
EDTCA20	EDTCA22	EDTCA27	EDTCA29	EDTCA31
EDTCA32	EDTCB14QBF	EDTCB18	EDTCF06	EDTCF08
EDTECB23	EG2401S-ER	EG4401S-AR	EG4801S-AR	EG7010B-FR
EG7500B-LS	EG9007D-NS-10	EG9013F-NZ	EL640.480-AF1	
F				
F-51136NCWHU-FW-AA	F-51167NCU-FW-AA	F-51320GNY-LY-AA	FLC38XGC6V-06	FLC43XWC6V-02
FLC44SXC8V	FLC485XC8V	FLC51UXC8V		
G				
G321D	G3243H	G3245H	G6485H-ff	g648d
GM1024768-133-TFT	GM1024768-141-TFM	GM1024768-141-TFT	GM1024768-150-TFT	GM1152234-68TFT
GM1152234-68-TFT	GM12801024-170A-TFT	GM12801024-170-TFM	GM1440234-70TFT	GM1440234-70-TFT
GM280220-18TFT	GM280220-18-TFT	GM320240-35TFT	GM320240-35-TFT-RF	GM320240-38TFTRF
GM320240-38-TFT-RF	GM480234-25TFT	GM480234-25-TFT	GM480234-40TFT	GM480234-40-TFT

	GM528220-18TFT	GM528220-18-TFT	GM800600-104-HB	GM800600-104-TFT	GM800600-104-TFT-TP
	GM800600-84-HB	GM800600-84-TFT	GM800600-84-TFT-TP	GM960234-56TFT	GM960234-56-TFT
H					
	H035QR01	H038QR03	HD66130T	HITACHI9.4	HLD0604-010000
	HLD0604HB	HLD0604HBSPEC0008	HLD0604SPEC9901(1)	HLD0604SPEC9901	HLD0805_0501
	HLD0805-500	HLD0805-500_0601	HLD1027-020100	HLD1027SPEC0005	HLD1027SPEC9905
	HLD1036SPEC9808	HLD1045	HLD1045E	HLD1045E-HIBRITE	HLD1210
	HLD1210H HIBRITE-800	HLD1210HIBRITE-500	HLD1506-010130	HLD1509-010130	HLD1511
	HLM6321	hlm6323	HLM7259	HLM7259-010100	hlm8619
	HLM8619-010560	HLM8620	HLM8620E	HSD141PK11-A	HSD141PX11-A
	Hsd150~1(1)	HSD150MX41-A	HSD150MX46-A	HT12X11-100	HT13X14-101-9910
	HT14X11-103	HT14X12-101	HT14X13-101	HT14X13-201	HT15X11-100
	HT15X11-200	HT15X12-100	HT15X13-200	HT17E11-100	HT18E22-100
I					
	IAXG01	I-SFT 100i.10X	I-SFT 50I.15X	I-SFT 50I.2	I-SFT 50i.M
	I-SFT 75i	ISFT50IE	ITQX20	ITQX20E	ITSV33N
	ITSV50E	ITSV53L	ITSX68	ITSX93	ITSX93E
	ITSX94	ITSX95	ITSX95C	ITSX96R	ITSX98E
	ITUX97	ITUX97C	ITXG00	ITXG75	ITXG76
	ITXG77C				
K					
	K3240H-FR	k3241h-he	k3242h-hl	k3243h-hf	k3244h-ff
	k3244h-ff0001	k3245h-fr	k3246h-ff	k3246h-hf	k3247h-fl
	k3247h-hl	k3248h-ff	k6484	K6488L-FF	KA5M-VGA-15
	KCB060VG1CB-A02	KCB065HV1AC-G40	KCB084SV1AE-G40	KCB104SV2AA-A20	KCB104VG1BB-A01
	KCB104VG2CA-A43	KCS038AA1AJ-G21	KCS038AA1AK-G21	KCS057QV1AD-G23	KCS057QV1AJ-G23
	KCS072VG1MB-G40	KCS072VG2MA-G16	KCS6448JSTT-X6	KHB065HV1AC-G83	KHB084SV1AE-G83
	KHS038AA1AJ-L89	KHS057QV1AJ-L89	KHS072VG1MB-L89	KHS072VG2MA-L89	KL6448USTS-FW
	KRS025EV0AB-B26	KRS038AA0AL-G25	KS6448ASTT-FW		
L					
	L016J-AA	L016J-AB	L025J	L025J-AA	L025J-AB
	L035J	L050J	L064J	L070J	L133X3-1(ADT13.3)
	L141X1	L141X1-1v06(ADT14.1)	L141X2(ADT14.1)	L150X1M-2(ADT15)	L150X1M-HB
	L150X2M	L150X2M-1	L170E1(ADT17)	L170E3(ADT17)	L170E3-1
	LB121S1	LB121S1-A2	LC_121S1	LC064N1	LC121S1
	LC121S1_A1MT	LC121S1-A1MT	LC151X01-C3	LC201V1	LC300W01
	LCA4SE01A	LCBKET302M2C	LCD 12T-HB	LCD1024E	LCD-12T
	LD1501	LJ024U35	LJ089MB2S01	LJ103LC2K01	LJ144LC2K01
	LJ280U32	LJ320U27	LJ32H028	LJ44HM01	LJ44KM01
	LJ640U25	LJ64EU34	LJ64H034	LJ64H051	LJ64H052
	LJ64HM01	LJ64K051	LJ64K052	LJ64KM01	LJ64ZU35
	LJ64ZU51	LJ64ZU52	LM_151X3_PL	LM_157E2-A2	LM011LB1H03

LM011b1H03-	LM014LC1S02	LM016LC1S07	LM016L-S	LM019LC1SXX
LM019LC1SXXX	LM024IB1S01	LM030LB1S02	LM032XMBL	LM038QB1R10
LM038QC1R10	LM044	LM044L-S	LM057QB1T04	LM057QBTT05
LM057QC1T01	LM057QCTT03	LM060VS1T54	LM073A-DC31	LM082VC1T01
LM082VC1TO1	LM094SS1T51	LM094YS1T64	LM100B-18DG01	LM100SS1T52
LM100SS1T523	LM100SS1T562	LM10V33	LM10V33	LM10V332
LM10V335	LM110A-12TX31	LM117A-150XA01B	LM118A-17E2	LM120A-151X3
LM121-10C306	LM121SS1T53	LM121SS1T531	LM12S02	LM12S402
LM12S44	LM12S47	LM12S48	LM12S49	LM130SS1T61
LM130SS1T611	LM133SS1T60	LM13X31	LM13X33	LM14A-12DG11
LM14X82	LM150X2	LM151X05	LM151X1	LM151X2
Lm151x3	LM151X3-A2	LM151X3-B3	LM151X3-C3	LM151X4
LM151X4-A3	LM157E1-A2	LM157E2-A2	LM15X11	LM15X80
LM16155	LM161556	LM16255	LM171W01-B3	LM181E05
LM181E05-C3	LM181E1	LM181E1-H2MN	LM181E3	LM181E3-A2
LM181ES	LM18X12	LM18X94	LM201U1	LM202KS1
LM20A21	LM211	LM213XB	LM215XB	LM220W1
LM220W1-A2	LM220W1-A2MN	LM24010Z	LM24014H	LM24014W
LM24022	LM24P20	LM320081	LM32008F	LM32010P
LM32018F	LM32019P	LM32019T	LM32C041	LM32C04P
LM32K071	LM32K10	LM32K101	LM32P07	LM32P18
LM40A21	LM40X21A	LM40X21B	LM480261	LM4Q30TA
LM5H40TA	LM5H40TB	LM5Q31	LM5Q32	LM6064
LM641521	LM64183P	LM64194F	LM64C12P	LM64C142
LM64C21P	LM64C350	LM64C391	LM64K103	LM64K104
LM64K111	LM64K837	LM64P10	LM64P11	LM64P12
LM64P70	LM64P83I	lm64p858	lm64p89I	LM64P89L
LM6Q31	LM6Q32	LM6Q33	LM6Q35	LM6Q40
LM6Q40A	LM7M632	LM7M633	LM7MS623	LM80C27
LM80C312	LM80C36	LM8M64	LM8V30	LM8V302
LM8V30kai	LM8V31	LM8V33	LM-97-005	LM9V381
LM-EH53-22NAK	LMG5278XUFC-00T	LMG6381QHGE	LMG6400PLGR	LMG6401PLGE
LMG6402PLFR	LMG7380QHFC	LMG7400PLFC	LMG7401PLBC	LMG7402PLFF
LMG7420PLFC-X	LMG7520RPFC	LMG7525RPFF	LMG7550XUFC	LP064V1
LP104S2	LP104S5	LP104S5_B2AP_Final	LP104S5-A2VT	LP104S5-B2AP
LP104V2-(W)	Lp104v2	LP104V2_W	LP104V2W	LP104V2-W
LP121S1-E	LP121S1-sb	LP121S4	LP121X1	LP133X7
LP133X7-H2CC	LP133X8	LP141E2	LP141E2-A1	LP141X2-B
LP141X6	LP141X61-A1IB	LP141X6-A1LB	LP141XA	LP150U1
LP150X1	LP157E1	LQ020A3FR23	LQ020A4FS01	LQ020A8FR23
LQ025A3FR37	LQ030ADFR27	LQ035A3FR27	LQ035A3FR37	LQ035Q2DD54
LQ038Q4DR01	LQ039Q2DS02	LQ039Q2DS53	LQ039Q2DS54	L1040A3FR27

LQ049B5DG01	LQ050A3AD01	LQ050A5BS01	LQ050Q5DR01	LQ056A3CH01
LQ056ACH01	LQ057Q3DC02	LQ058T5DRQ1	LQ058T5GG01	LQ05A5BS01
LQ05AW136	LQ064A5CG01	LQ064ACG01	LQ064D341	LQ064V1DS11
LQ065T5GG01	LQ065TGG02	LQP65T9BR51	LQ065T9DR51	LQ065TGG01
LQ06AN102	LQ06BW506	LQ070T3GR01	LQ070T5BG01	LQ070T5CRQ1
LQ070T5DG01	LQ070T5GG01	LQ070T5GG02	LQ07BW516	LQ07BW566
LQ080T5GG01	LQ084S1DH01	LQ084V1DG21	LQ084V1DG21-ALL	LQ084V2DS01
LQ09D340	LQ09PS01	LQ104S1DG21	LQ104V1DC31	LQ104V1DG11
LQ104V1DG11-ALL	LQ104V7DS01	LQ10D031	LQ10D131	LQ10D32A
LQ10D34G	LQ10D36	LQ10D367	LQ10D3671	LQ10D367-ALL
LQ10D368	LQ10D42	LQ10D421	LQ10D4211	LQ10M421
LQ10PX21	LQ10S21	LQ11DS03	LQ11S31	LQ11S31G
LQ11S31pin	LQ121S1dDG11	LQ121S1dDG31	LQ121S1DG21	LQ121S1DG31_8
LQ12DX03	LQ12DX12	LQ12S08	LQ12S31	LQ12S41
LQ12S56A	LQ12X02	LQ12X12	LQ12X51	LQ133X1LH01
LQ133X1TS70	LQ13X21	LQ13X31	LQ141X1DG21	LQ14D412
LQ14X01E	LQ14X03	LQ14X03E	LQ150U1LG01	LQ150X1DG11
LQ150X1DG16	LQ150X1DG41	LQ150X1DG41	LQ150X1DG51	LQ150X1DG55
LQ150X1DW11	LQ15X01	LQ15X01W	LQ160E1LG01	LQ181E1DG01
LQ181E1DG11	LQ181E1DW21	LQ181E1LW31	LQ196U1LG01	LQ201U1LW01TL
LQ4FN31	LQ5AW116	LQ5AW136	LQ64D34	LQ64D341
LQ64D343	LQ64D343-ALL	LQ64dD341	LQ64SQ1	LQ6AN101
LQ6AN102	LQ6AW31K	LQ6BW12K	LQ6BW506	LQ7BW566
LQ9D021	LQ9D03B	LQ9D161	LQ9D340	LQ9PS01
LRUDC801XA	LT121S1-105	LT121SS-105	LT121SS-105-W1	LT121SU-123
LT150X1-151	LT170E2-131	LT170E2-131-T2	LTBGCH191J	LTE052T-060
LTE052T-061	LTE072T-05X	LTE072T-50	LTE072T-51	LTM035A776
LTM035A776C	LTM04C380K	LTM04C380Kv10	LTM06C310	LTM06C310v01
LTM08343	LTM08C343S	LTM08C343Sv41	LTM08C351	LTM08C351-V01
LTM10C0021	LTM10C209A	LTM10C209H	LTM10C210	LTM10C210-v10
LTM10C273	LTM10C306L	LTM10C306Lv22	LTM10C348Sv24	LTM10C348U
LTM121SI	LTM121SI-T01	LTM121SI-T01_v2	LTM12C285	LTM12C289
LTM12C289-v30	LTM150XH-L01	LTM150XH-L04	LTM150XH-T01 A	LTM150XH-T01
LTM150XI-A01	LTM150XS-T01	LTM15C151A	LTM15C423Sv20	LTM15C428S
LTM15C429	LTM15C429V03	LTM15C441	LTM170E4	LTM170E4-131
LTM170E4-L01	LTM170E5-L01	LTM170E5-L03	LTM170EI-A01	LTM181E4-L01
LTM181E4-L01	LTM190U1-I01	LTM213U3-L02	LTM213U3-L07	LTM240W1-L01
LTM70W10_MM1	LTN104S2-L01	LTN104S2-L01A	LTN121XU-L01	LVM104SD full
LVM104SD	LVM104VD	LVM104XSB	LVM121SD	LVM151XD

M



M121-53DH	M121-55HB	M141x101	M141-X76C	M150X1-01
M150X2	M150X2-01	M150X2-03	M150X2-T03	M150X2-T05

M150X3	M150X3-03	M150X3-S07	M150X3-T03	M150X3-T05
M150X3-T06	M150X3-T08	m169123	M170E1	M170E2
M170E3-L01	M170E4-L01	M170E4-L02	M180E1-01	M180E2
M180E2_L01	M2_lcd_kit	M4_lcd_kit	MD22292A1	Mircotouch
MM121-53DH				

N 

N104s1	N104S1-01	N121x1	N141X101	N141x201
NL10276AC24-05	NL10276AC28-01	NL10276AC28-01E	NL10276AC28-01L	NL10276AC28-02E
NL10276AC28-02L	NL10276AC28-05D	NL10276AC28-05R	NL10276AC30-01	NL10276AC30-01A
NL10276AC30-03	NL10276AC30-03A	NL10276AC30-03L	NL10276AC30-04L	NL10276AC30-04R
NL10276AC30-07	NL10276AC30-09	NL10276BC12-01	NL10276BC12-02	NL10276BC20-04
NL10276BC28-05D	NL10276BC28-08B	NL10276BC28-21A	NL10276BC30-04D	NL128102AC23-02
NL128102AC23-02A	NL128102AC28-01	NL128102AC28-01A	NL128102AC28-01E	NL128102AC28-01F
NL128102AC28-04	NL128102AC28-07	NL128102AC31-01	NL128102AC31-01B	NL128102AC31-01E
NL128102AC31-02	NL128102AC31-02A	NL128102BC23-03	NL12876AC39-01	NL12876BC26-21
NL160120AC27-01	NL160120AC27-01A	NL160120AC27-01E	NL3224AC35-01	NL3224AC35-06
NL3224AC35-10	NL3224AC35-13	NL3224BC35-20	NL6448AC33-15	NL6448AC33-18
NL6448AC33-18A	NL6448AC33-29	NL6448AC33-31D	NL6448AC63-01	NL6448BC20-08
NL6448BC26-01	NL6448BC33-31	NL6448BC33-46	NL6448BC63-01	NL6448CC33-25
NL6448CC33-30	NL8060AC26-05	NL8060AC26-11	NL8060AC26-17	NL8060AC31-12G
NL8060BC26-17	NL8060BC31-17	NL8060BC31-20	NP3302MF01	NP4201MF02
NP4203MF02	NP42B1ME01	NP42B1MF01	NP50C1MF01	OEM93C-04

P 

P25EN1	P35EN1	P50AN4AP01	PA079DS1T1	PW070DS1
RKY025ABG25				

S 

SA09Q001-BZA	SC09Q002-A	SC09Q002-AZA	SC09Q002-B	SC09Q002-BZA
SP10Q002	SP10Q002-T	SP10Q003-T	SP10Q004-T	SP10Q005-T
SP10Q006-T	SP14N001	SP14N001-Z1	SP14N001-Z1A	SP14N001-ZZA
SP14Q001	SP14Q002-A1	SP14Q002-B1	SP14Q002-C1	SP14Q002-C1A
SP14Q002-C2A	SP14Q002-T	AP14Q003	SP16H001-T	SR16H005-R
SX09Q002-B	SX09Q002-BZA	SX14Q001	SX14Q001-ZZA	SX16H003
SX16H003-ZZA	SX19V001-Z1	SX19V001-Z1A	SX19V007	SX19V007-ZZA
SX21V001-Z4	SX21V001-Z4A	SX25S003	SX25S003-ZZA	SX25S004
SX25S004-ZZA				

T 

T-51378L025J-FW-P-AB	T-51379L035J-FW-P-AA	T-51380L050J-FW-P-AA	T-51381L064J-FW-P-AA	T-51382D064J-FW-P-AA
T-51383L070J-FW-P-AA	T-51384L079J-FW-P-AA	T-51410D104-FW-P-AA	TFD70W10_MM1	TM038QV_67A02Aa
TM038QV-67A02A	TM058WA_22L01	TM058WA-22I01	TM058WA-22L03	TM070WA_22L01
TM070WA-22I01	TM070WA-22L03	TM080SV_04L01	TM080SV-04I01	TM100SV_02L03
TM100SV-02I03	TM100SV-02I04	TM121SV_02L01	TM121SV-02I01	TM121SV-02L11
TM121XG_02L01	TM121XG_02L02D	TM121XG_02L10	TM121XG-02I01	TM121XG-02I02D

	TM121XG-02I10	TM133XG_02L07	TM133XG_02L08A	TM133XG-02I07	TM133XG-02I08A
	TM141XG_02L05	TM141XG-02I05	TM150XG_02L02E	TM150XG_02L02F	TM150XG_22L01A
	TM150XG_22L03A	TM150XG_26L06	TM150XG_26L07	TM150XG_76N08	TM150XG-02I02E
	TM150XG-02I02F	TM150XG-22I01A	TM150XG-22I03A	TM150XG-26I06	TM150XG-26I07
	TM150XG-76N08	TM181SX_76N02	TM181SX-76N02	TX31D30VC1CAA	TX38D14VC0
	TX38D31VC1CAA	TX38D31VC1HAA			

U ↑

	UB084S01	UB104S01	UB104S01	UB104S01-1	UB133X01
	UB141X01	UB141X03	UM141X01	UM170E01	UP_025D01
	UP_040D01	UP_056D01	UP_070W01	UP_084S01	UP015D02
	UP018D01	UP018D02-1	UP018D11	UP025D01	UP025D11-1
	UP025D11-1v1	UP025D11-2	UP040D01	UP056D01	UP068D01
	UP070W01	UP20D01	UP61v01	UP61V01v3	UR035Q01
	UR038Q01	UR038Q03			

V ↑

	V16C6448AB	V16C6448AC	V26L8060AA	V26L8060AA	V26L8060BA
	V26L8060BA				

W ↑

	WG240128D	WG320240A	WG320240B	WG320240C	WG320240D
	WX240160A	WX320240A	WX480320A	WX640480A	