

Spec. No.	413-212-095
Version :	2
Total pages :	16
Date :	2001.02.21

AU 14.1" COLOR TFT-LCD MODULE

TENTATIVE SPECIFICATION

MODEL NAME: B141XN04-2 (UB141X03)

<p>The content of this technical information is subject to change without notice. Please contact Unipac or its agent for further information.</p>

Approved by	Checked by	Prepared by
<i>J.C. Su</i>	<i>TP Chiang</i>	<i>Eric Lo</i>

Contents:

A. Physical specification	P2
B. Electrical specifications	P3
1. Pin assignment.....	P3
2. Absolute maximum ratings.....	P4
3. Electrical characteristics.....	P5
a. Typical operating conditions.....	P5
b. Display color v.s. input data signals.....	P6
c. Input signal timing.....	P7
d. Display position.....	P8
e. Backlight unit.....	P9
C. Optical specifications	P10
D. Reliability test items	P12
E. Display quality	P12
F. Handling precaution	P12
G. Packing form	P13
Appendix:	
Fig.1-(a) LCM outline dimensions(Front side)	P14
Fig.1-(b) LCM outline dimensions (Back side).....	P15
Fig.2 Timing chart.....	P16

A. Physical specifications

NO.	Item	Specification	Remark
1	Display resolution(pixel)	1024(H)× 768(V)	
2	Active area(mm)	285.7(H)× 214.3(V)	
3	Screen size(inch)	14.1(Diagonal)	
4	Pixel pitch(mm)	0.279(H)× 0.279(V)	
5	Color configuration	R. G. B. Vertical stripe	
6	Overall dimension(mm)	298.5(W)× 226.7(H)× 5.2Typ.(D)(5.5 Max.)	Note 1
7	Weight(g)	(445 ± 20)	
8	Surface treatment	Hard coating(3H), anti-glare of the front polarizer	

Note 1: Refer to Fig. 1.

B. Electrical specifications

1.Pin assignment

(1).Input signal interface

CN1 (20P) connector : FI-SEB-20P-HF10(JAE)

Pin no	Symbol	Function	Etc.
1	V _{CC}	Power supply ,3.3 V (typical)	
2	V _{CC}	Power supply ,3.3 V (typical)	
3	GND	Ground	
4	GND	Ground	
5	RxIN0-	-LVDS differential data input (R0-R5,G0)	
6	RxIN0+	+LVDS differential data input (R0-R5,G0)	
7	GND	Ground	
8	RxIN1-	-LVDS differential data input (G1-G5,B0-B1)	
9	RxIN1+	+LVDS differential data input (G1-G5,B0-B1)	
10	GND	Ground	
11	RxIN2-	-LVDS differential data input (B2-B5, HS, VS, DE)	
12	RxIN2+	+LVDS differential data input (B2-B5, HS, VS, DE)	
13	GND	Ground	
14	CKIN-	Clock Signal(-)	
15	CKIN+	Clock Signal(+)	
16	GND	Ground	
17	NC	Reserved for supplier test	
18	NC	Reserved for supplier test	
19	GND	Ground	
20	GND	Ground	

(2) LVDS channel interface data mapping diagram

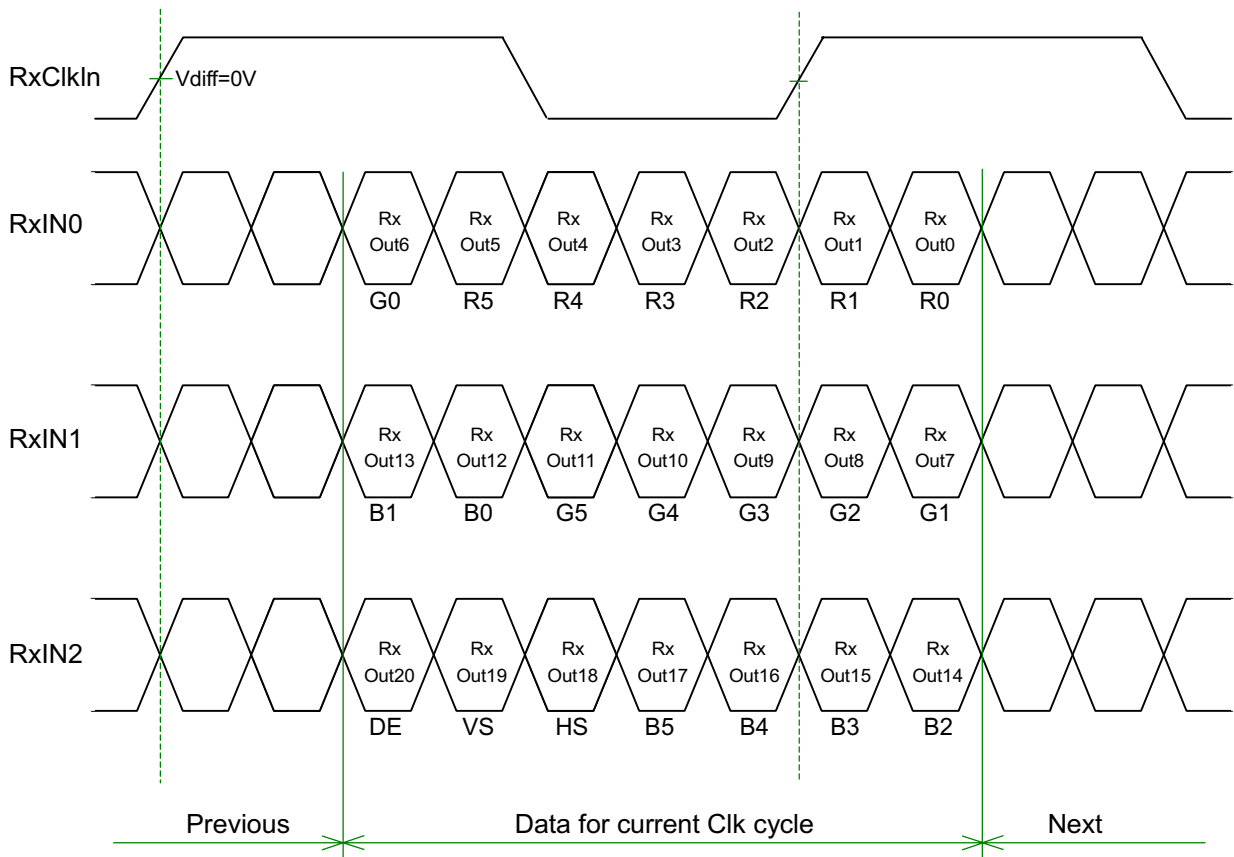

2. Absolute maximum ratings

(GND = 0 V)

Parameter	Symbol	Values		Unit	Remark
		Min.	Max.		
Power voltage	V_{CC}	-0.3	4	V_{DC}	At 25°C
Input signal voltage	V_{LH}	-0.3	$V_{CC}+0.3$	V_{DC}	At 25°C
Operating temperature	T_{op}	0	+50	°C	Note 1
Storage temperature	T_{st}	-20	+60	°C	Note 1

Note 1: The relative humidity must not exceed 90% non-condensing at temperatures of 40°C or less. At temperatures greater than 40°C, the wet bulb temperature must not exceed 39°C. When operate at low temperatures, the brightness of CCFL will drop and the life time of CCFL will be reduced.

Note 2: The unit should not be exposed to corrosive chemicals.

3. Electrical characteristics

a. Typical operating conditions

	Item	Symbol	Min.	Typ.	Max.	Unit	Remark
Power supply voltage	Input voltage	V_{CC}	3.0	3.3	3.6	V	
	Current consumption	I_A	-	(350)	-		Note 1
		I_B	-	-	(550)	mArms	
	Inrush current	I_{RUSH}	-	-	(1800)	mApeak	Note 2
Internal logic	Low voltage	V_{IL}	0	-	$0.3 V_{CC}$		
	High voltage	V_{IH}	$0.7V_{CC}$	-	V_{CC}		
	Power ripple voltage	V_{RP}	-	-	(100)	mVp-p	

Note 1: Effective value (mArms) at $V_{CC} = 3.3 V/25^{\circ}C$.

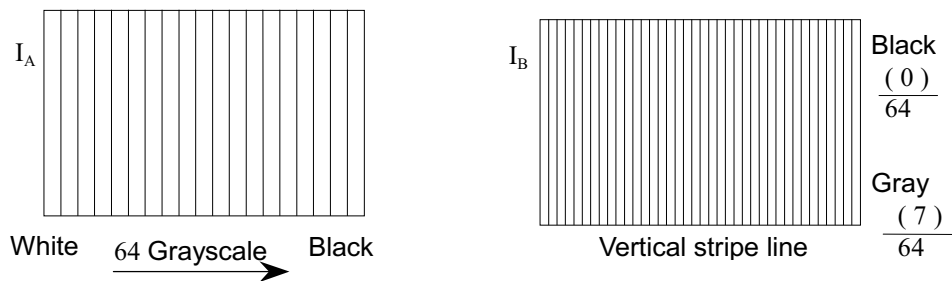

Note 2: Refer to the following power-on condition.

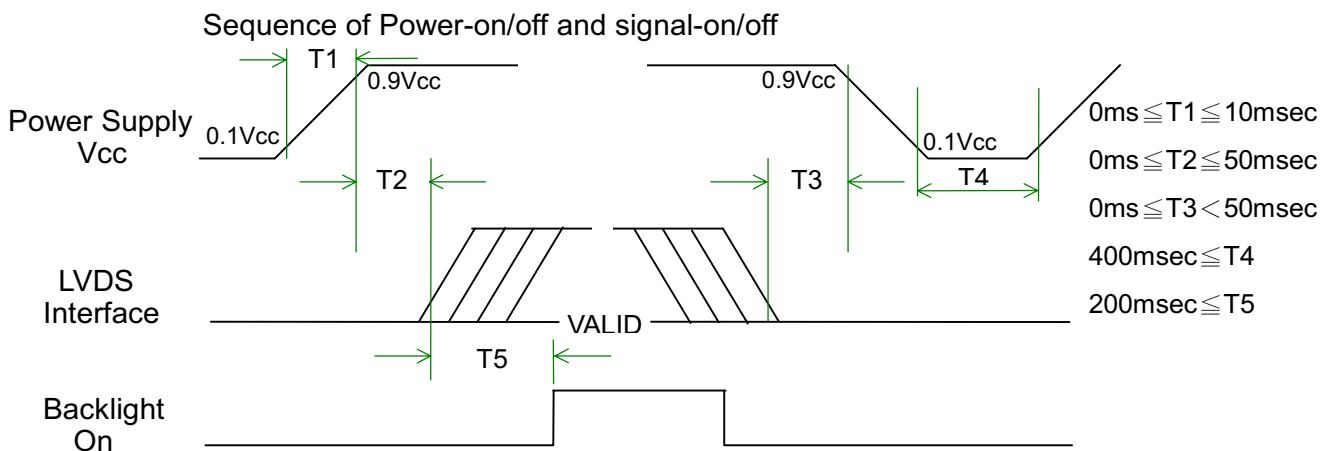
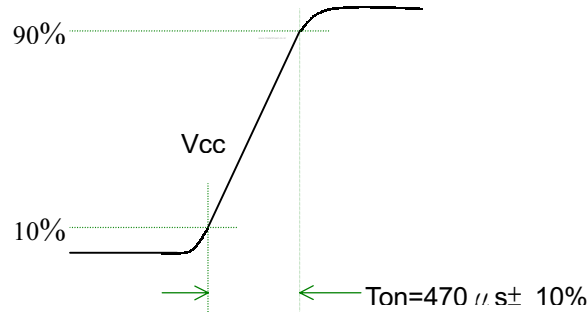

Apply the lamp voltage within the LCD operating range. When the backlight turns on before the LCD operation or the LCD turns off before the backlight turns off, the display may momentarily become abnormal.

Caution

The above on/off sequence should be applied to avoid abnormal function in the display.

In case of handling:

Make sure to turn off the power when you plug the cable into the input connector or pull the cable out of the connector.

b. Display color v.s. input data signals

Display colors		Data signal (0 : Low level, 1: High level)																	
		R5	R4	R3	R2	R1	R0	G5	G4	G3	G2	G1	G0	B5	B4	B3	B2	B1	B0
Basic colors	Black	0	0	0	0	0	0	0	0	0	0	0	0	0	0	0	0	0	0
	Blue	0	0	0	0	0	0	0	0	0	0	0	0	1	1	1	1	1	1
	Red	1	1	1	1	1	1	0	0	0	0	0	0	0	0	0	0	0	0
	Magenta	1	1	1	1	1	1	0	0	0	0	0	0	1	1	1	1	1	1
	Green	0	0	0	0	0	0	1	1	1	1	1	1	0	0	0	0	0	0
	Cyan	0	0	0	0	0	0	1	1	1	1	1	1	1	1	1	1	1	1
	Yellow	1	1	1	1	1	1	1	1	1	1	1	1	0	0	0	0	0	0
	White	1	1	1	1	1	1	1	1	1	1	1	1	1	1	1	1	1	1
Red grayscale	Black	0	0	0	0	0	0	0	0	0	0	0	0	0	0	0	0	0	0
	Dark	0	0	0	0	0	1	0	0	0	0	0	0	0	0	0	0	0	0
	↑																		
	↓																		
	bright	1	1	1	1	0	1	0	0	0	0	0	0	0	0	0	0	0	0
Green grayscale	Black	0	0	0	0	0	0	0	0	0	0	0	0	0	0	0	0	0	0
	Dark	0	0	0	0	0	0	0	0	0	1	0	0	0	0	0	0	0	0
	↑																		
	↓																		
	bright	0	0	0	0	0	0	1	1	1	1	0	1	0	0	0	0	0	0
Blue grayscale	Black	0	0	0	0	0	0	0	0	0	0	0	0	0	0	0	0	0	0
	Dark	0	0	0	0	0	0	0	0	0	0	0	0	0	0	0	1	0	0
	↑																		
	↓																		
	bright	0	0	0	0	0	0	0	0	0	0	0	0	1	1	1	1	0	1
Blue grayscale		0	0	0	0	0	0	0	0	0	0	0	0	1	1	1	1	1	0
		0	0	0	0	0	0	0	0	0	0	0	0	1	1	1	1	1	1
		0	0	0	0	0	0	0	0	0	0	0	0	1	1	1	1	1	1
	Blue	0	0	0	0	0	0	0	0	0	0	0	0	1	1	1	1	1	1

Note : Each basic color can be displayed in 64 gray scales using the 6 bit data signals. By combining the 18-bit data signals(R,G,B), the 262,144 colors can be achieved on the display.

c. Input signal timing

Timing diagrams of input signal are shown in Fig 2.

(1). Timing characteristics of input signals

	Item	Symbol	Min.	Typ.	Max.	Unit	Remark
CLK clock	Frequency	Fck	50	65	66	MHz	
	Period	Clk	15.2	15.4	20	ns	
Hs Horizontal sync	Period	Th	1040	1344	1648	Clk	
			20	20.7	-	μs	
	Display period	Thd	1024			Clk	
	Pulse width	Thw	2	136	-	Clk	
	Display start	The	296	296	296	Clk	DE non-using
			8	296	600	Clk	DE using
	Front porch	Thf	8	24	-	Clk	
	Back porch	Thb	4	160	-	Clk	
Blanking	Thb1	16	320	624	Clk		
Vs Vertical sync	Phase shift	Tvpd	2	320	-	Clk	
	Period	Tv	803	806	895	Th	
			-	16.6	20	ms	
	Display width	Tvd	768			Th	
	Pulse width	Tvw	-1	6	-	Th	
	Display start	Tve	-	35	-	Th	DE non-using
	Front porch	Tvf	0	3	-	Th	
Blanking	Tvb1	35	38	127	Th		

Available data input timing

Horizontal	DE non-using	When DE signal is fixed Low, after falling edge of Hs, counting 296 clocks, then getting valid data from 297th clock's data.
	DE using	Valid data is according to rising edge of "DE" signal. The time should be 8 to 600 clocks between falling edge of Hs and rising edge of DE.
Vertical	DE non-using	After falling edge of Vs, counting 35 Th, then getting 36th Th's data.
	DE using	Valid data is according to the first rising edge of "DE" signal after DE keeps low during blanking period.

(2). The timing condition of LVDS

Item	Symbol	Min.	Typ.	Max.	Unit
The differential level	VID	0.1	-	0.6	V
The common mode input voltage	VIC	$\frac{ VID }{2}$	-	$2.4 - \frac{ VID }{2}$	V
The input setup time	tsu1	500	-	-	ps
The input hold time	th1	500	-	-	ps

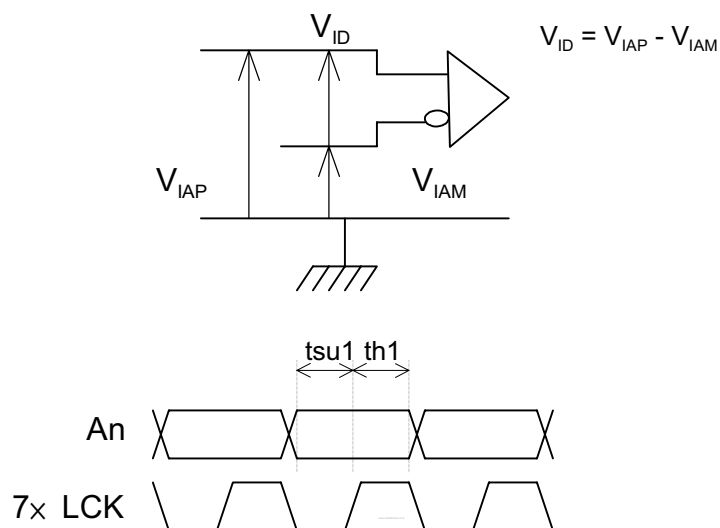

d. Display position

D(1,1)	D(2,1)	D(X,1)	D(1023,1)	D(1024,1)
D(1,2)	D(2,2)	D(X,2)	D(1023,2)	D(1024,2)
⋮		⋮	⋮	⋮
D(1,Y)	D(2,Y)	D(X,Y)	D(1023,Y)	D(1024,Y)
⋮		⋮	⋮	⋮
D(1,767)	D(2,767)	D(X,767)	D(1023,767)	D(1024,767)
D(1,768)	D(2,768)	D(X,768)	D(1023,768)	D(1024,768)

e.Backlight unit

The backlight system is an edge-lighting type with a CCFT(Cold Cathode Fluorescent Tube).

The characteristics of a single lamp are shown in the following tables.

Parameter	Symbol	Min.	Typ.	Max.	Unit	Remark
Lamp voltage	V_L	(594)	(660)	(726)	Vrms	Note 1
Lamp current	I_L	3	6	6.5	mArms	Note 1
Power consumption	P_L	-	(3.96)		W	Note 2
Lamp starting voltage	V_s	-	-	(1530(T=0°C))	Vrms	Note 3
		-	-	(1250(T=25°C))		
Frequency	F_L	50	60	80	KHz	Note 4
Lamp life time	L_L	10000	-	-	Hr	Note 1, 5

Note 1: T= 25°C

Note 2: Inverter should be designed with the characteristic of lamp. When you are designing the inverter, the output voltage of the inverter should comply with the following conditions.

- (1). The area under the positive and negative cycles of the waveform of the lamp current and lamp voltage should be area symmetric (the symmetric ratio should be larger than 90%).
- (2). There should not be any spikes in the waveform.
- (3). The waveform should be sine wave as possible.
- (4). Lamp current should not exceed the maximum value within the operating temperature (It is prohibited to over the maximum lamp current even if operated in the non-guaranteed temperature). When lamp current over the maximum value for a long time, it may cause fire. Therefore, it is recommend that the inverter should have the current limited circuit.

Note 3: The inverter open voltage should be designed larger than the lamp starting voltage at T=0°C otherwise backlight may be blinking for a moment after turning on or not be able to turn on. The open voltage should be measured after ballast capacitor. If an inverter has shutdown function it should keep its open voltage for longer than 1 second even if lamp connector is open.

Note 4: Lamp frequency may produce interference with horizontal synchronous frequency and this may cause line flow on the display. Therefore lamp frequency shall be detached from the horizontal synchronous frequency and its harmonics as far as possible in order to avoid interference.

Note 5: Brightness ($I_L=6mA$) to be decrease to the 50% of the initial value.

Note 6: CN2 connector (backlight): BHSR-02VS-1 (JST)

Mating connector: SM02B-BHSS-1-TB (JST)

Pin no.	Symbol	Function	Remark
1	H	CCFL power supply(H.V.)	Cable color: Pink
2	L	CCFL power supply(GND)	Cable color: White

C. Optical specifications (Note 1, Note 2)

Item	Symbol	Condition	Specification			Unit	Remark
			Min.	Typ.	Max.		
Response time Rising time Falling time	Tr Tf	$\theta = 0^\circ$	- -	20 30	40 50	ms	Note 4
Contrast ratio	CR	$\theta = 0^\circ$	150	250	-		Note 3,5
Viewing angle Top Bottom Left Right		$CR \geq 10$	10 30 40 40	- - - -	- - - -	deg.	Note 3,8
Brightness	5 points	Y_L	$\theta = 0^\circ$	(120)	(150)	-	Note 3,6,7,9
Color chromaticity(CIE)	Wx	$\theta = 0^\circ$	-	0.310	-		Note 3
	Wy		-	0.330	-		
	Rx		-	TBD	-		
	Ry		-	TBD	-		
	Gx		-	TBD	-		
	Gy		-	TBD	-		
	Bx		-	TBD	-		
	By		-	TBD	-		
White uniformity	δ_w		-	-	1.8		Note 3,9

Note 1: Ambient temperature = 25°C.

Note 2: To be measured in dark room after lighting the backlight for 30 minutes.

Note 3: To be measured with a viewing cone of 1° by Topcon luminance meter BM-5A.

Note 4: Definition of response time:

The output signals of BM-7 are measured when the input signals are changed from "Black" to "White" (falling time) and from "White" to "Black" (rising time), respectively. The response time interval between the 10% and 90% of amplitudes. Refer to figure as below.

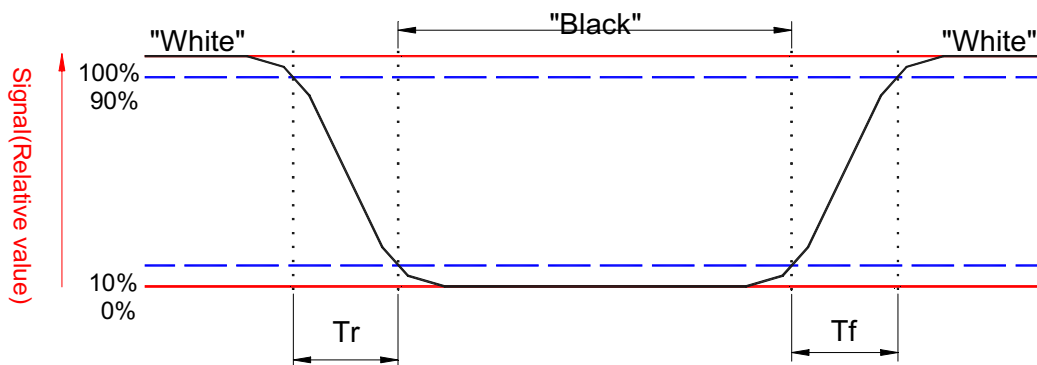

Note 5. Definition of contrast ratio:

Contrast ratio is calculated with the following formula.

$$\text{Contrast ratio (CR)} = \frac{\text{Brightness on the "White" state}}{\text{Brightness on the "Black" state}}$$

Note 6: Definition of brightness:

$$\text{Brightness}(Y_L) = \frac{Y_{LD} + Y_{LE} + Y_{LG} + Y_{LI} + Y_{LJ}}{5}$$

Note 7: Driving conditions for CCFL : $I_L = 6.0 \text{ mA}$, 60 KHz frequency.

Note 8: Definition of viewing angle.

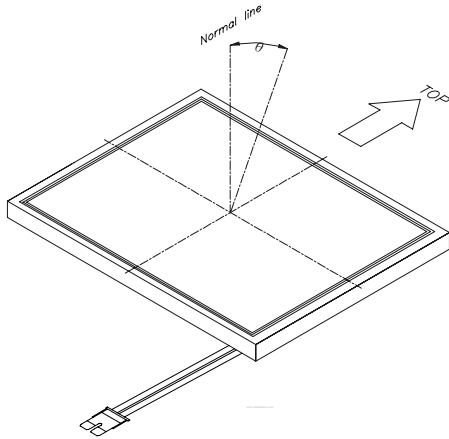

Note 9: Definition of white uniformity:

White uniformity is defined as the following with thirteen measurements (A~M).

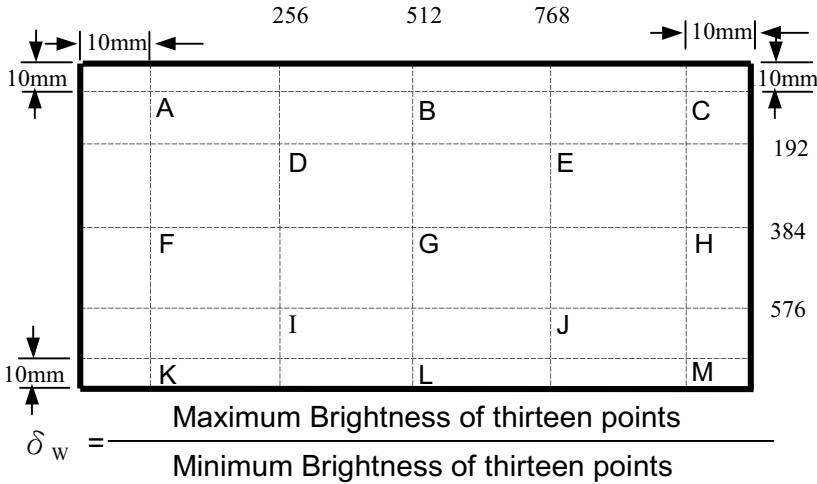

D. Reliability test items(Note 1)

Test tem	Test Condition	Judgement	Remark
High temperature storage	60°C, 240Hrs	Display quality	Note 1, 2
Low temperature storage	-20°C, 240Hrs	Display quality	Note 1, 2
High temperature & high humidity operation	40°C, 90%RH, 240Hrs (No condensation)	Display quality	Note 1, 2
High temperature operation	50°C, 240Hrs	Display quality	Note 1, 2
Low temperature operation	0°C, 240Hrs	Display quality	Note 1, 2
Temperature cycling (non-operation)	-20°C~60°C 1Hr, 10mins, 1Hr, 5cycles	Display quality	Note 1, 2
Electrostatic discharge (non-operation)	150pF, 150Ω, ± 10KV, 1second, 9 points on the panel, 10 times each place	Display function	Note 2, 3
Vibration (non-operation)	Sweep:1.5G, 10Hz ~ 300Hz ~ 10Hz/10min 10 min for each direction X, Y, Z (6 Hrs in total)	Display quality	Note 1, 2
Mechanical shock (non-operation)	Half-sine wave 240G, 2ms, ± X, ± Y, ± Z Once for each direction	Display quality	Note 1, 2
Interface connector ESD test	100pF, 0Ω, ± 200V, machine mode, 1 second, 10 times for each pin	Display quality	Note 2

Note 1: Evaluation should be tested after storage at room temperature for one hour.

Note 2: There should be no change which might affect the practical display function when the display quality test is conducted under normal operating condition.

Note 3: The discharging points are shown as below.

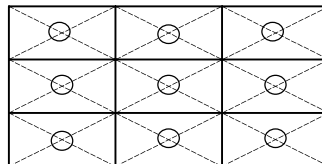

E. Display quality

The display quality of the color TFT-LCD module should be in compliance with the Unipac's incoming inspection standard.

F. Handling precaution

The Handling of the TFT-LCD should be in compliance with the Unipac's handling principle standard.

G. Packing form

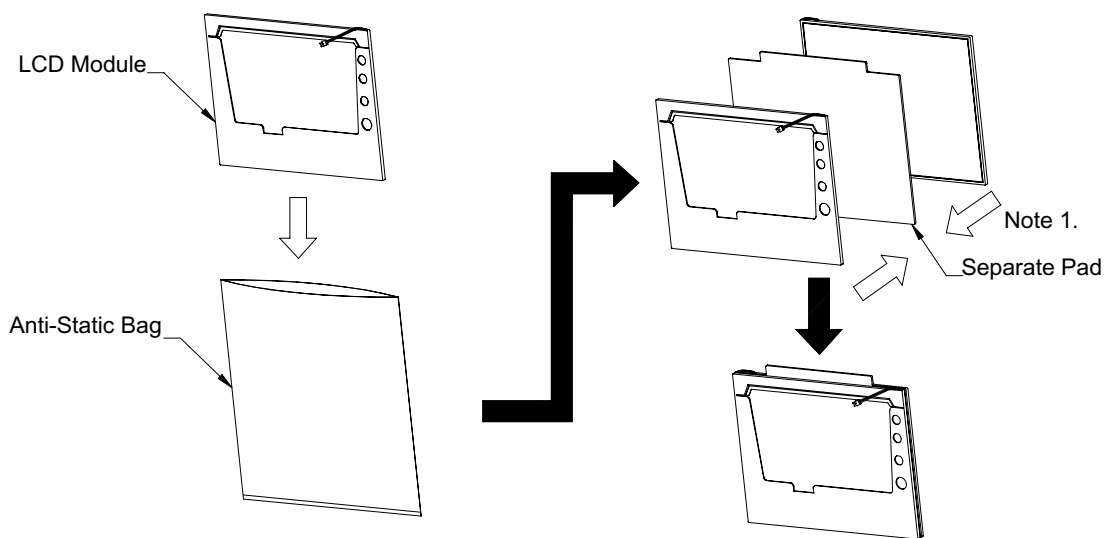

Note :

- 1.The panel of each LCD Module faces toward separation pad.
- 2.Max. capacity : 20 LCD Modules/Carton.
- 3.Max. weight : 15kg/Carton.
- 4.Meas. : 458mm*412mm*365mm.

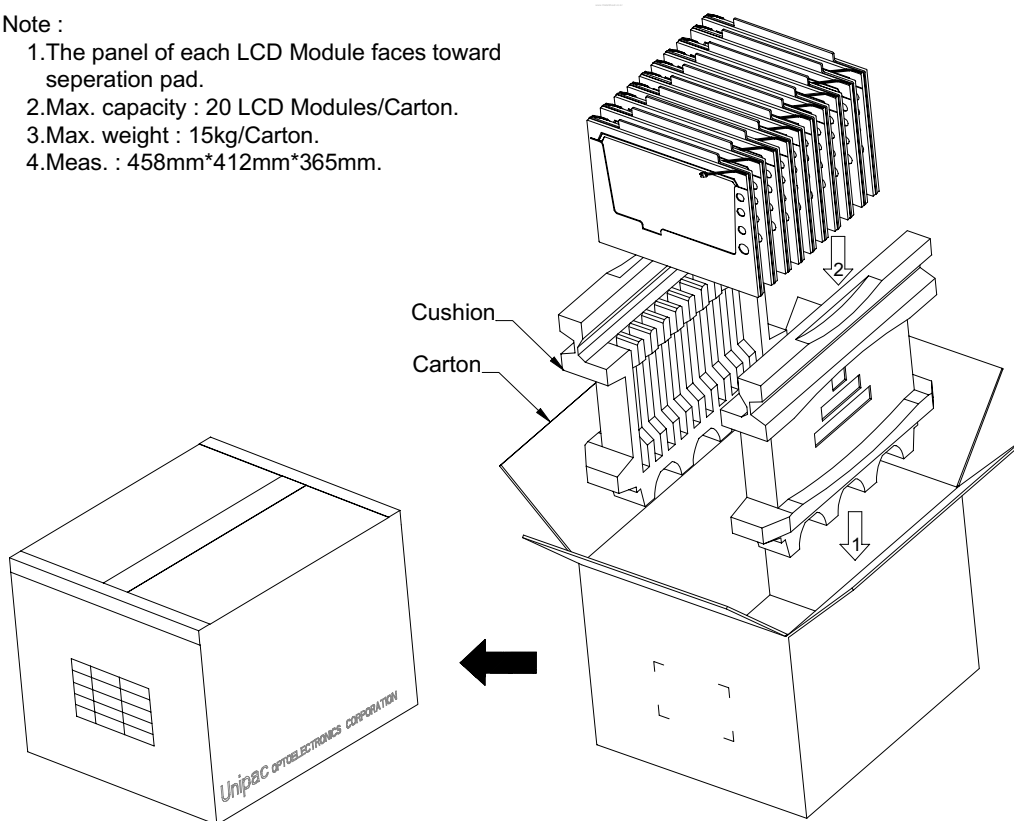

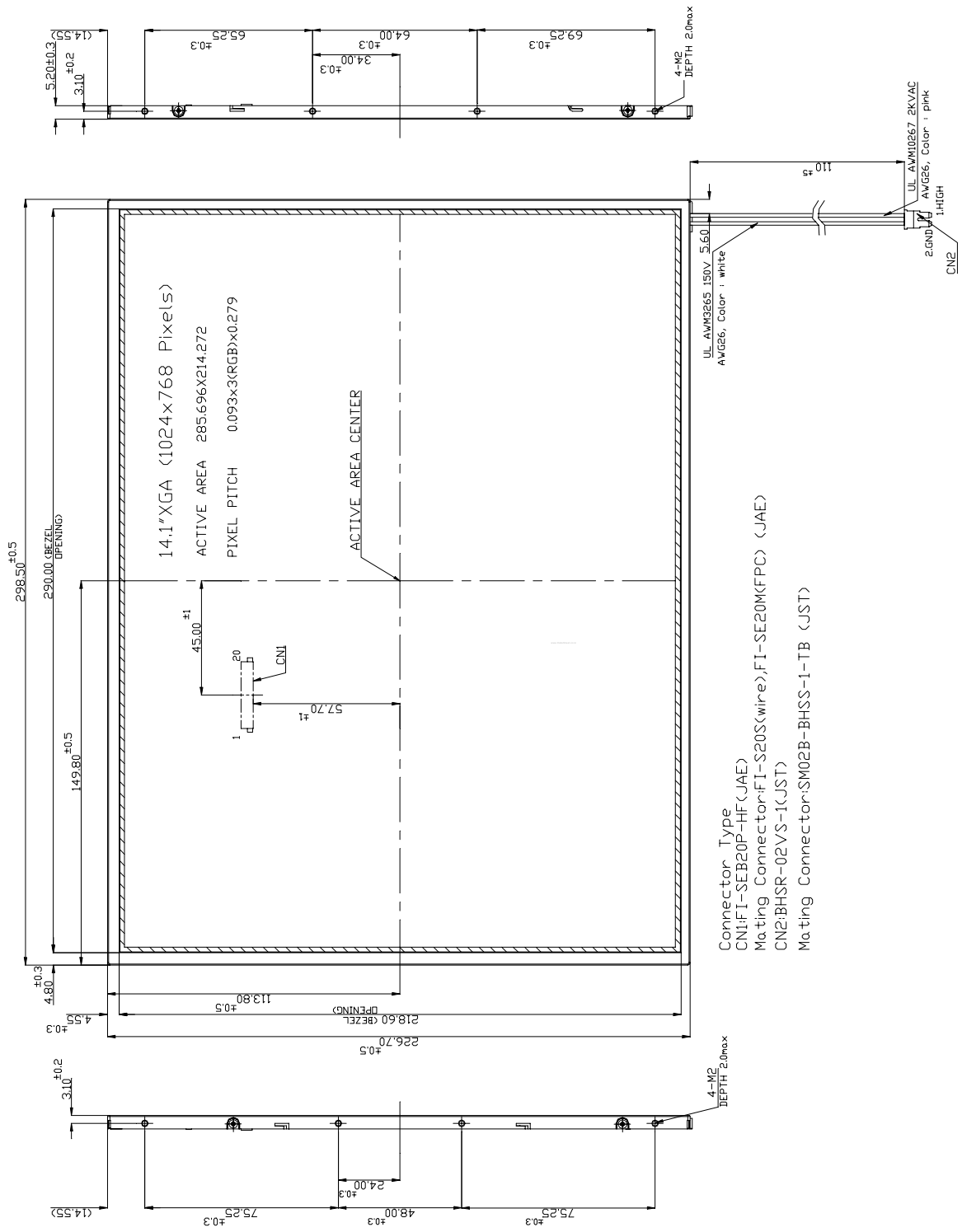

Fig.1-(a) LCM outline dimensions (Front side)

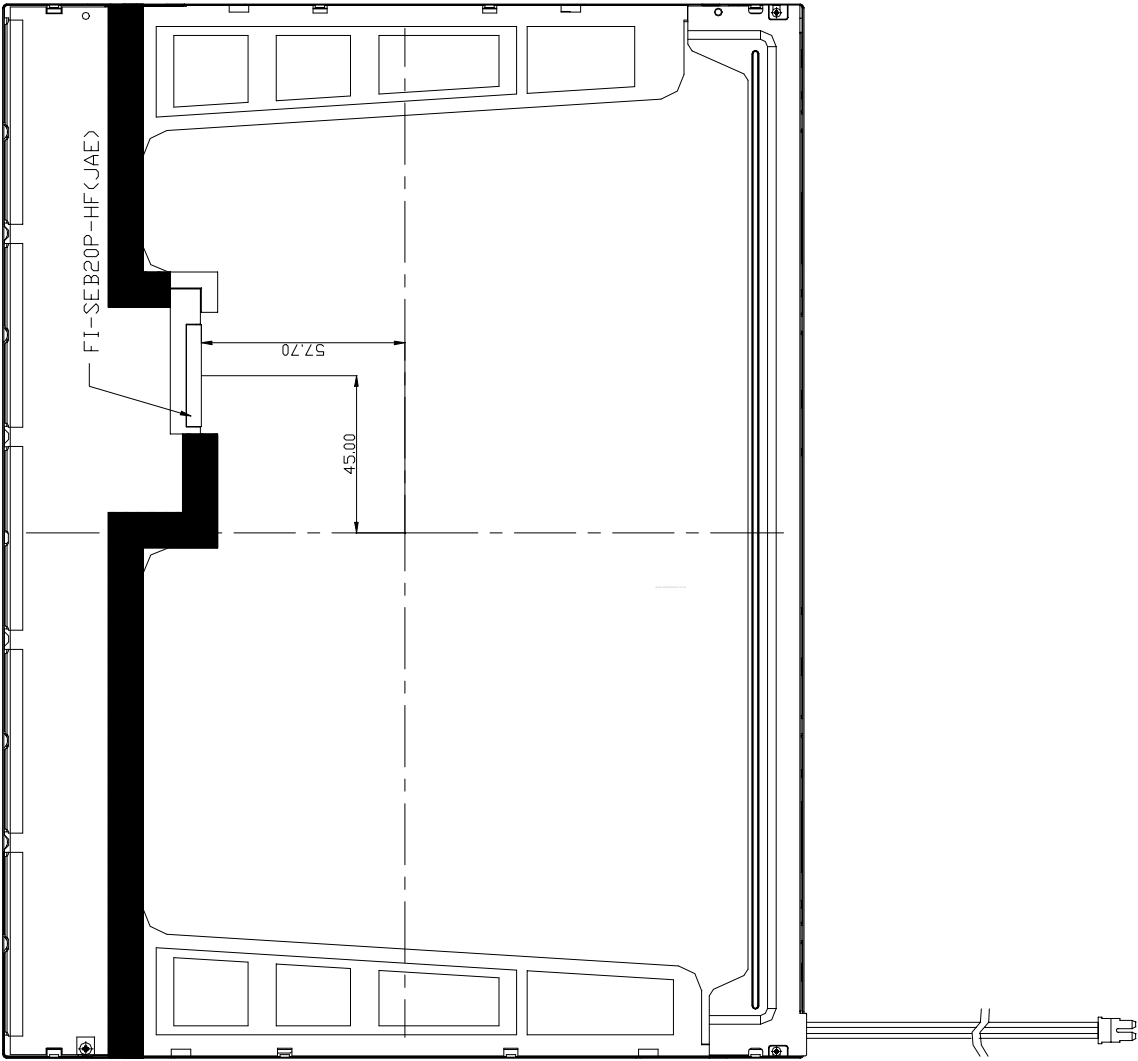

Fig.1-(b) LCM outline dimensions (Back side)

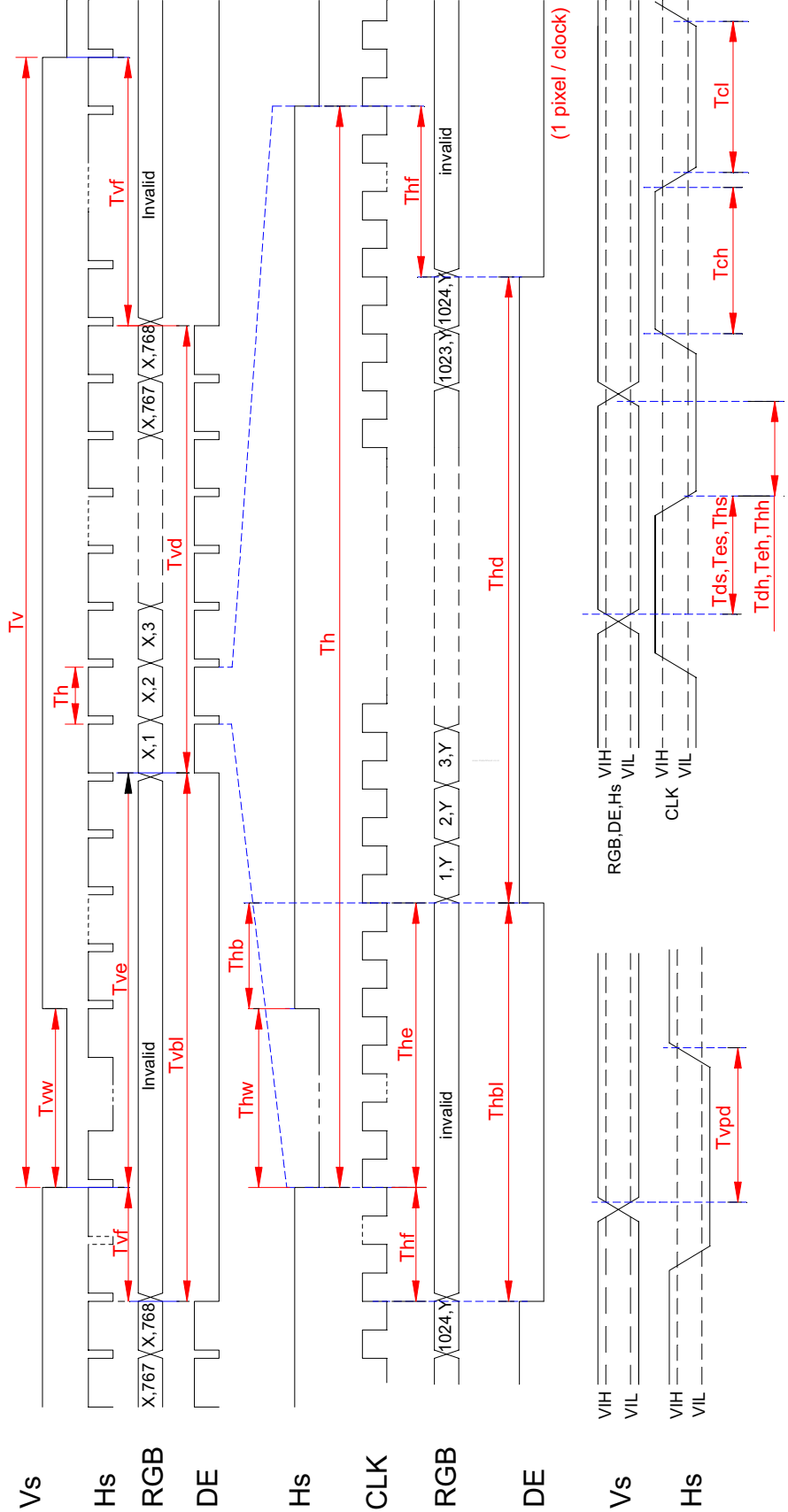

Fig.2 Timing chart