

CONTENTS

1. GENERAL DESCRIPTION	4
1.1 OVERVIEW	4
1.2 GENERAL SPECIFICATIONS	4
2. MECHANICAL SPECIFICATIONS	4
3. ABSOLUTE MAXIMUM RATINGS	5
3.1 ABSOLUTE RATINGS OF ENVIRONMENT	5
3.2 ELECTRICAL ABSOLUTE RATINGS	5
3.2.1 TFT LCD MODULE	5
3.2.2 BACKLIGHT UNIT	6
4. ELECTRICAL SPECIFICATIONS	7
4.1 FUNCTION BLOCK DIAGRAM	7
4.2. INTERFACE CONNECTIONS	8
4.3 ELECTRICAL CHARACTERISTICS	9
4.3.1 LCD ELETRONICS SPECIFICATION	9
4.3.2 Vcc Power Dip Condition	12
4.3.3 BACKLIGHT UNIT	12
4.3.4 LIGHTBAR Connector Pin Assignment	13
4.4 LVDS INPUT SIGNAL SPECIFICATIONS	14
4.4.1 LVDS DATA MAPPING TABLE	14
4.4.2 COLOR DATA INPUT ASSIGNMENT	15
4.5 DISPLAY TIMING SPECIFICATIONS	16
4.6 POWER ON/OFF SEQUENCE	18
5. OPTICAL CHARACTERISTICS	19
5.1 TEST CONDITIONS	19
5.2 OPTICAL SPECIFICATIONS	19
6. RELIABILITY TEST ITEM	22
7. Mechanical Strength Characteristics	23
7.1 Mechanical Strength Specifications	23
7.2 Test Conditions	23
7.3 Definition of Test Points	23
8. PACKING	24
8.1 PACKING SPECIFICATIONS	24
8.2 PACKING METHOD	24
8.3 PALLET	24
9. INX MODULE LABEL	25
10. PRECAUTIONS	26
10.1 ASSEMBLY AND HANDLING PRECAUTIONS	26
10.2 STORAGE PRECAUTIONS	26
10.3 OPERATION PRECAUTIONS	26
10.4 SAFETY PRECAUTIONS	26
10.5 SAFETY STANDARDS	26
10.6 OTHER	26

1. GENERAL DESCRIPTION

1.1 OVERVIEW

G170EGE-L50 is a 17" TFT Liquid Crystal Display module with WLED Backlight unit and 30 pins 2ch-LVDS interface. This module supports 1280 x 1024 SXGA mode and can display up to 16.7M colors.

1.2 GENERAL SPECIFICATIONS

Item	Specification	Unit	Note
Screen Size	17" real diagonal	-	-
Driver Element	a-si TFT active matrix	-	-
Pixel Number	1280 x R.G.B. x 1024	pixel	-
Pixel Pitch	0.264 (H) x 0.264 (V)	mm	-
Pixel Arrangement	RGB vertical stripe	-	-
Display Colors	16.7M	color	-
Transmissive Mode	Normally white	-	-
Surface Treatment	AG type, 3H hard coating, Haze 25	-	-
Luminance, White	400nits (Typ.)	Cd/m2	
Color Gamut	90% of NTSC(Typ.)	-	-
ROHS, Halogen Free & TCO 5.2	ROHS, Halogen Free, TCO 5.2 compliance		
Power Consumption	TBD		(1)

Note (1) The specified power consumption : Total= cell (reference 4.3.1)+BL (reference 4.3.3)

2. MECHANICAL SPECIFICATIONS

Item	Min.	Typ.	Max.	Unit	Note	
Module Size	Horizontal (H)	358.0	358.5	359.0	mm	(1)
	Vertical (V)	296.0	296.5	297.0	mm	
	Thickness (T)	-	10.5	11.0	mm	
Bezel Area	Horizontal	341.7	341.9	342.1	mm	
	Vertical	274.2	274.4	274.6	mm	
Active Area	Horizontal	-	337.92	-	mm	
	Vertical	-	270.36	-	mm	
Weight	(1260)	(1400)	(1470)	g		

Note (1) Please refer to the attached drawings for more information of front and back outline dimensions.

3. ABSOLUTE MAXIMUM RATINGS

3.1 ABSOLUTE RATINGS OF ENVIRONMENT

Item	Symbol	Value		Unit	Note
		Min.	Max.		
Storage Temperature	TST	-40	85	°C	(1)
Operating Ambient Temperature	TOP	-30	80	°C	(1), (2)

Note (1)

- (a) 90 %RH Max. ($T_a \leq 40\text{ °C}$).
- (b) Wet-bulb temperature should be 39 °C Max. ($T_a > 40\text{ °C}$).
- (c) No condensation.

Note (2) Panel surface temperature should be -40°C min. and 85°C max under $V_{CC}=5.0V$, $f_r=60Hz$, typical LED string current, 25°C ambient temperature, and no humidity control. Any condition of ambient operating temperature, the surface of active area should be keeping not higher than 85°C.

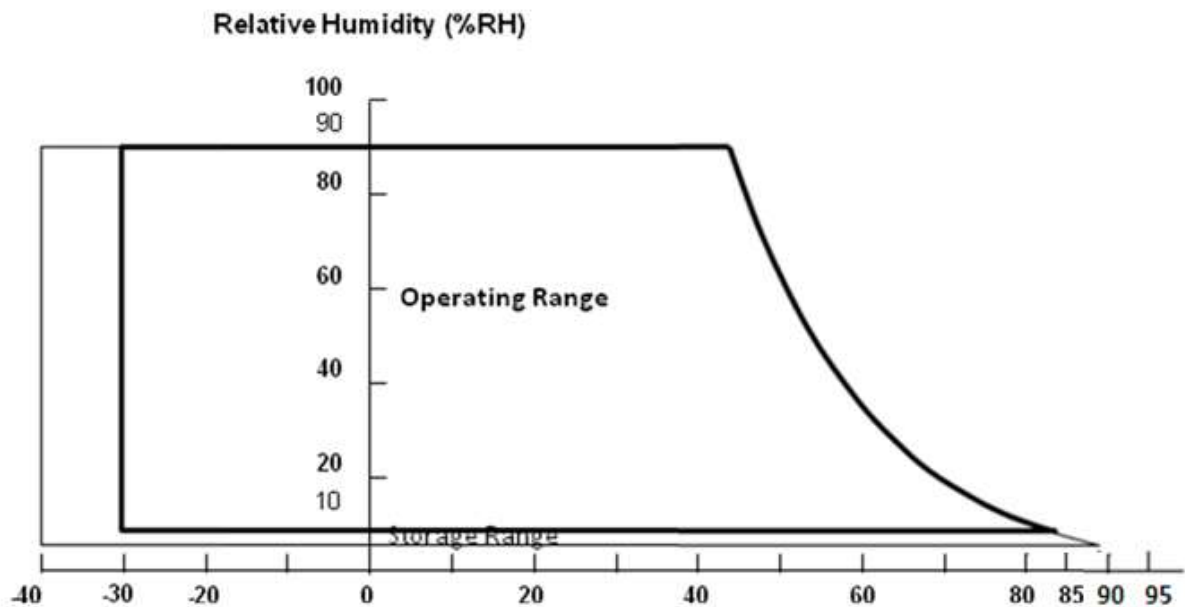

3.2 ELECTRICAL ABSOLUTE RATINGS

3.2.1 TFT LCD MODULE

Item	Symbol	Value		Unit	Note
		Min.	Max.		
Power Supply Voltage	VCCS	-0.3	6.0	V	(1)
Logic Input Voltage	V_{IN}	-0.3	3.6	V	

3.2.2 BACKLIGHT UNIT

Item	Symbol	Value			Unit	Note
		Min.	Typ	Max.		
LED Forward Current Per Input Pin	I_F	0	40	44	mA	(1), (2) Duty=100%
LED Pulse Forward Current Per Input Pin	I_P	---	---	150	mA	(1), (2) Pulse Width \leq 10msec. and Duty \leq 30%

Note (1) Permanent damage to the device may occur if maximum values are exceeded. Function operation should be restricted to the conditions described under Normal Operating Conditions.

Note (2) Specified values are for input pin of LED light bar at $T_a=25\pm 2$ °C (Refer to 4.3.3 and 4.3.4 for further information).

4. ELECTRICAL SPECIFICATIONS

4.1 FUNCTION BLOCK DIAGRAM

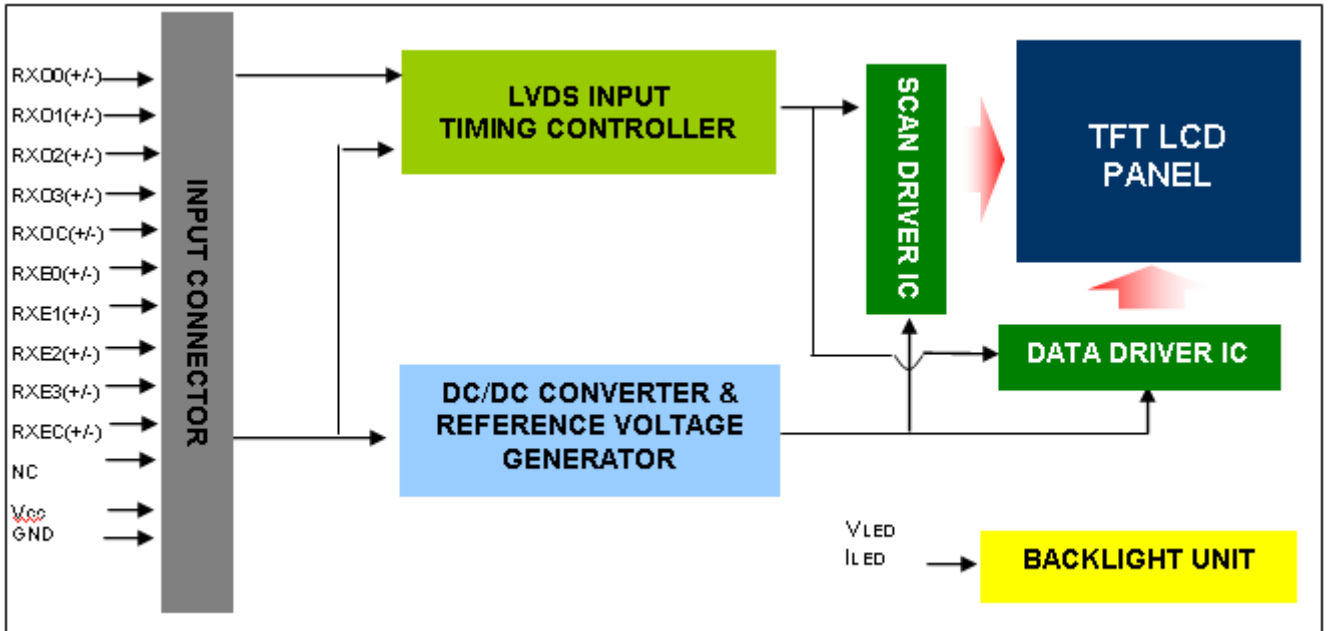

4.2. INTERFACE CONNECTIONS

PIN ASSIGNMENT

Pin	Name	Description
1	RXO0-	Negative LVDS differential data input. Channel O0 (odd)
2	RXO0+	Positive LVDS differential data input. Channel O0 (odd)
3	RXO1-	Negative LVDS differential data input. Channel O1 (odd)
4	RXO1+	Positive LVDS differential data input. Channel O1 (odd)
5	RXO2-	Negative LVDS differential data input. Channel O2 (odd)
6	RXO2+	Positive LVDS differential data input. Channel O2 (odd)
7	GND	GND
8	RXOC-	Negative LVDS differential clock input. (odd)
9	RXOC+	Positive LVDS differential clock input. (odd)
10	RXO3-	Negative LVDS differential data input. Channel O3(odd)
11	RXO3+	Positive LVDS differential data input. Channel O3 (odd)
12	RXE0-	Negative LVDS differential data input. Channel E0 (even)
13	RXE0+	Positive LVDS differential data input. Channel E0 (even)
14	GND	GND
15	RXE1-	Negative LVDS differential data input. Channel E1 (even)
16	RXE1+	Positive LVDS differential data input. Channel E1 (even)
17	GND	GND
18	RXE2-	Negative LVDS differential data input. Channel E2 (even)
19	RXE2+	Positive LVDS differential data input. Channel E2 (even)
20	RXEC-	Negative LVDS differential clock input. (even)
21	RXEC+	Positive LVDS differential clock input. (even)
22	RXE3-	Negative LVDS differential data input. Channel E3(even)
23	RXE3+	Positive LVDS differential data input. Channel E3 (even)
24	GND	GND
25	NC	For LCD internal use only, Do not connect
26	NC	For LCD internal use only, Do not connect
27	NC	For LCD internal use only, Do not connect
28	Vcc	+5.0V power supply
29	Vcc	+5.0V power supply
30	Vcc	+5.0V power supply

Note (1) Connector Part No.: Foxconn:GS23301-0321R-7H or P-TWO:187098-30091 or FCN:WF13-422-3033

Note (2) User's connector Part No:

Mating Wire Cable Connector Part No.: FI-X30H(JAE) or FI-X30HL(JAE)

Mating FFC Cable Connector Part No.: 217007-013001 (P-TWO) or JF05X030-1 (JAE).

Note (3) The first pixel is odd.

Note (4) Input signal of even and odd clock should be the same timing.

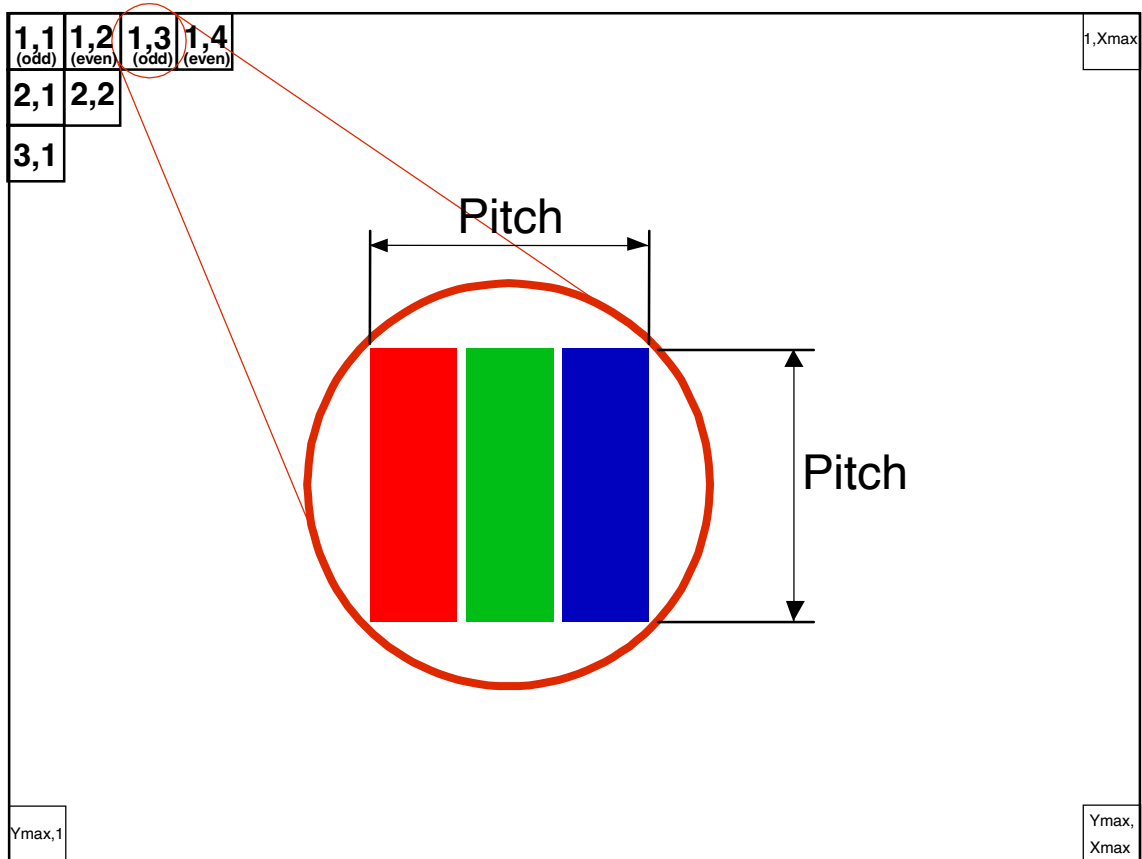

4.3 ELECTRICAL CHARACTERISTICS

4.3.1 LCD ELETRONICS SPECIFICATION

Parameter	Symbol	Value			Unit	Note
		Min.	Typ.	Max.		
Power Supply Voltage	V _{CC}	4.5	5	5.5	V	-
Ripple Voltage	V _{RP}			300	mV	-
Rush Current	I _{RUSH}			2	A	(2)
Power Supply Current	White		(335)	(390)	mA	(3)a
	Black		(490)	(580)	mA	(3)b
	Vertical Stripe		(420)	(490)	mA	(3)c
Power Consumption	PLCD		(2.45)	(2.90)	Watt	(4)
LVDS differential input voltage	V _{id}	100		600	mV	(5)
LVDS common input voltage	V _{ic}	1.0	1.2	1.4	V	(5)
Logic High Input Voltage	V _{IH}			100	mV	(5)
Logic Low Input Voltage	V _{IL}	-100			mV	(5)

Note (1) The ambient temperature is $T_a = 25 \pm 2$ °C.

Note (2) Measurement Conditions:21

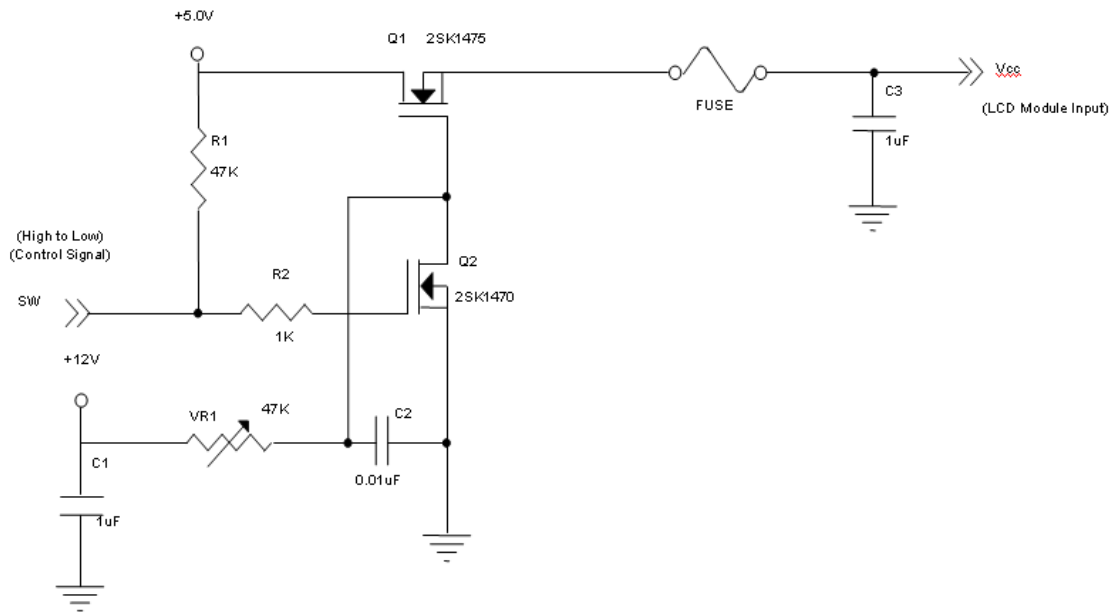

Vcc rising time is 470μs

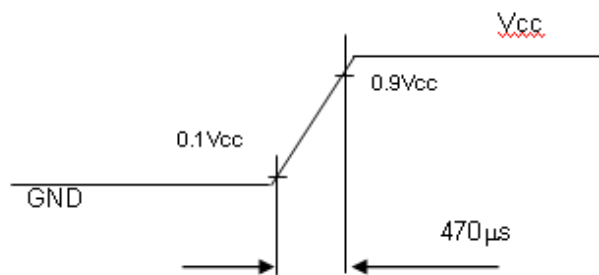

Note (3) The specified power supply current is under the conditions at $V_{cc} = 5.0\text{ V}$, $T_a = 25 \pm 2\text{ }^\circ\text{C}$, $F_r = 75\text{ Hz}$, whereas a power dissipation check pattern below is displayed.

a. White Pattern



Active Area

b. Black Pattern

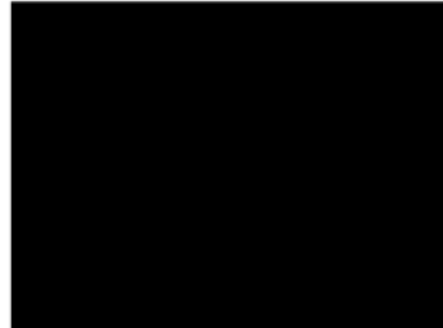

Active Area

c. Vertical Stripe Pattern

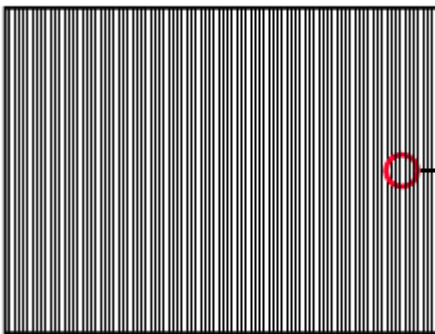

Active Area

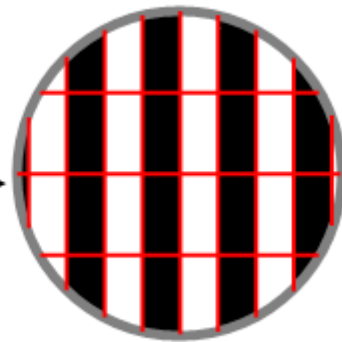

Note (4) The power consumption is specified at the pattern with the maximum current.

Note (5) VID waveform condition

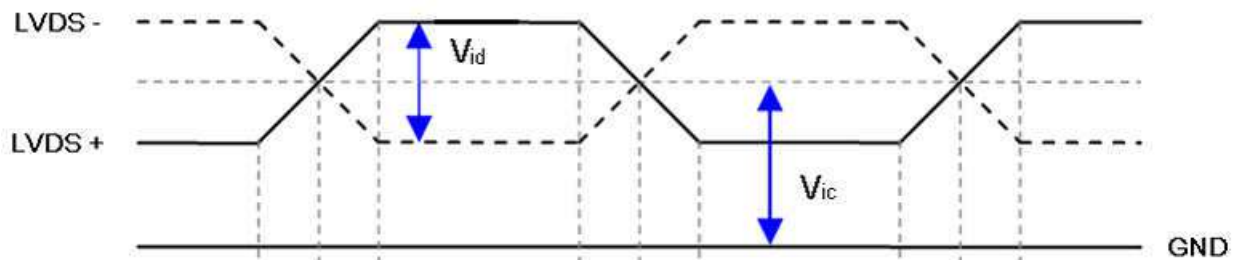

4.3.2 Vcc Power Dip Condition

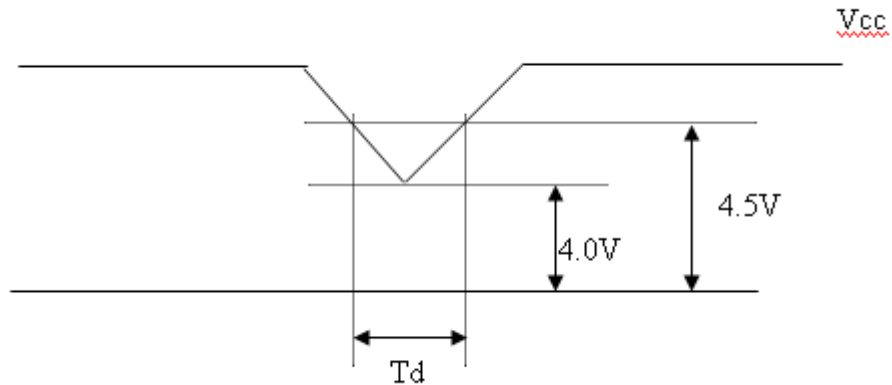

Dip condition: $4.0 \leq V_{cc} \leq 4.5$, $T_d \leq 20\text{ms}$

4.3.3 BACKLIGHT UNIT

Parameter	Symbol	Value			Unit	Note
		Min.	Typ.	Max.		
LED Light Bar Input Voltage Per Input Pin	VPIN	(34.2)	(36)	(37.8)	V	(1), Duty=100%,
LED Light Bar Current Per Input Pin	IPIN	(37.6)	(40)	(42.4)	mA	(1), (2) Duty=100%
LED Life Time	LLED	(40000)			Hrs	(3)
LED Light Bar Power Consumption	PBL	---	(5.76)	(6.05)	W	(1) Duty=100%,

Note (1) LED light bar input voltage and current are measured by utilizing a true RMS multimeter as shown below:

Note (2) $PBL = IPIN \times VPIN \times (4)$ PBL.

Note (3) The lifetime of LED is defined as the time when LED packages continue to operate under the conditions at $T_a = 25 \pm 2 \text{ }^\circ\text{C}$ and $I = (65)\text{mA}$ (per chip) until the brightness becomes $\leq 50\%$ of its original value.

Note (4) The module must be operated with constant driving current.

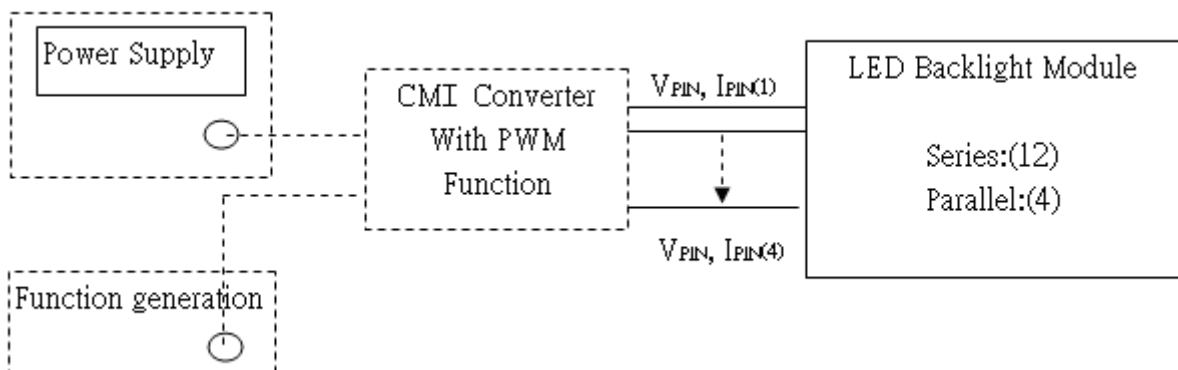

4.3.4 LIGHTBAR Connector Pin Assignment

- (1) Connector (wire type): J.S.T.(SM10B-SHLS-TF)
- (2) L/B power input connector drawing. J.S.T.(SM10B-SHLS-TF)

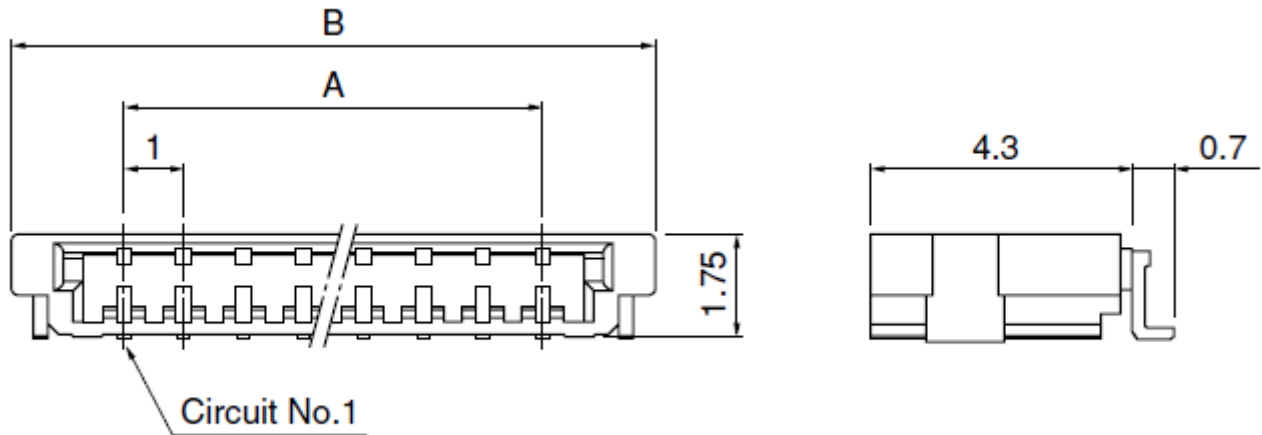

Circuits	Model No.		Insulation O.D. (mm)				Q'ty/ reel
	Normal type	Offset type	Normal type		Offset type		
			A	B	A	B	
2	SM02B-SHLS-TF	—	1.0	4.8	—	—	4,500
5	SM05B-SHLS-TF	—	4.0	7.8	—	—	4,500
6	SM06B-SHLS-TF	—	5.0	8.8	—	—	4,500
7	SM07B-SHLS-TF	—	6.0	9.8	—	—	4,500
8	SM08B-SHLS-TF	SM08B-SHLS-1-TF	7.0	10.8	7.0	12.0	4,500
10	SM10B-SHLS-TF	—	9.0	12.8	—	—	4,500
11	SM11B-SHLS-TF	—	10.0	13.8	—	—	4,500
12	SM12B-SHLS-TF	—	11.0	14.8	—	—	4,500
14	SM14B-SHLS-TF	SM14B-SHLS-1-TF	13.0	16.8	13.0	18.0	4,500
16	SM16B-SHLS-TF	—	15.0	18.8	—	—	4,500
20	SM20B-SHLS-TF	SM20B-SHLS-1-TF	19.0	22.8	19.0	24.0	4,500
22	SM22B-SHLS-TF	—	21.0	24.8	—	—	4,500
26	SM26B-SHLS-TF	—	25.0	28.8	—	—	4,500
30	SM30B-SHLS-TF	—	29.0	32.8	—	—	4,500

Other equivalents please refer to individual drawing

CN2

Pin	Symbol	Description
1	VIN	12V Input Power
2	VIN	12V Input Power
3	VIN	12V Input Power
4	VIN	12V Input Power
5	GND	Ground
6	VLED	Ground
7	VLED	Ground
8	VLED	Ground
9	LED EN	ENABLE 3.3V
10	LED PWM	PWM Dimming HI 3.3V ; LOW 0V

Note (1) User's Mating Connector Part No.:J.S.T(SHLP-10V-S-B)

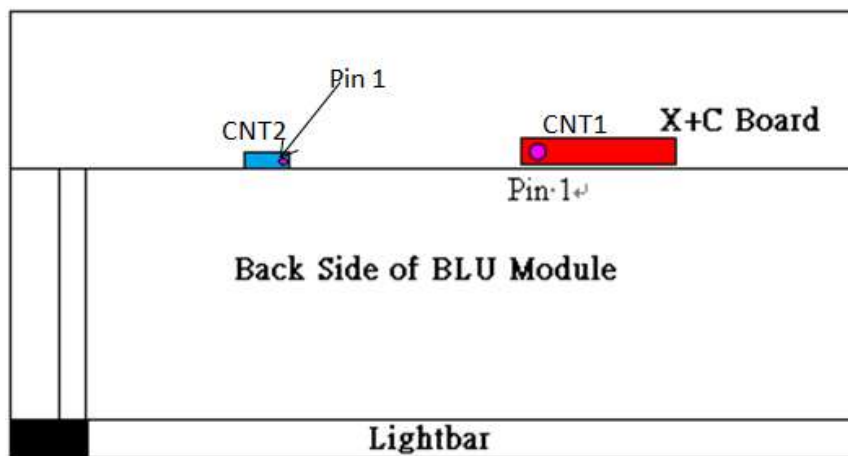

4.4 LVDS INPUT SIGNAL SPECIFICATIONS

4.4.1 LVDS DATA MAPPING TABLE

LVDS Channel O0	LVDS output	D7	D6	D4	D3	D2	D1	D0
	Data order	OG0	OR5	OR4	OR3	OR2	OR1	OR0
LVDS Channel O1	LVDS output	D18	D15	D14	D13	D12	D9	D8
	Data order	OB1	OB0	OG5	OG4	OG3	OG2	OG1
LVDS Channel O2	LVDS output	D26	D25	D24	D22	D21	D20	D19
	Data order	DE	NA	NA	OB5	OB4	OB3	OB2
LVDS Channel O3	LVDS output	D23	D17	D16	D11	D10	D5	D27
	Data order	NA	OB7	OB6	OG7	OG6	OR7	OR6
LVDS Channel E0	LVDS output	D7	D6	D4	D3	D2	D1	D0
	Data order	EG0	ER5	ER4	ER3	ER2	ER1	ER0
LVDS Channel E1	LVDS output	D18	D15	D14	D13	D12	D9	D8
	Data order	EB1	EB0	EG5	EG4	EG3	EG2	EG1
LVDS Channel E2	LVDS output	D26	D25	D24	D22	D21	D20	D19
	Data order	DE	NA	NA	EB5	EB4	EB3	EB2
LVDS Channel E3	LVDS output	D23	D17	D16	D11	D10	D5	D27
	Data order	NA	EB7	EB6	EG7	EG6	ER7	ER6

4.4.2 COLOR DATA INPUT ASSIGNMENT

The brightness of each primary color (red, green and blue) is based on the 8-bit gray scale data input for the color. The higher the binary input, the brighter the color. The table below provides the assignment of color versus data input.

Color		Data Signal																							
		Red								Green								Blue							
		R7	R6	R5	R4	R3	R2	R1	R0	G7	G6	G5	G4	G3	G2	G1	G0	B7	B6	B5	B4	B3	B2	B1	B0
Basic Colors	Black	0	0	0	0	0	0	0	0	0	0	0	0	0	0	0	0	0	0	0	0	0	0	0	0
	Red	1	1	1	1	1	1	1	1	0	0	0	0	0	0	0	0	0	0	0	0	0	0	0	0
	Green	0	0	0	0	0	0	0	0	1	1	1	1	1	1	1	1	0	0	0	0	0	0	0	0
	Blue	0	0	0	0	0	0	0	0	0	0	0	0	0	0	0	0	1	1	1	1	1	1	1	1
	Cyan	0	0	0	0	0	0	0	0	1	1	1	1	1	1	1	1	1	1	1	1	1	1	1	1
	Magenta	1	1	1	1	1	1	1	1	0	0	0	0	0	0	0	0	1	1	1	1	1	1	1	1
	Yellow	1	1	1	1	1	1	1	1	1	1	1	1	1	1	1	1	0	0	0	0	0	0	0	0
	White	1	1	1	1	1	1	1	1	1	1	1	1	1	1	1	1	1	1	1	1	1	1	1	1
Gray Scale Of Red	Red(0) / Dark	0	0	0	0	0	0	0	0	0	0	0	0	0	0	0	0	0	0	0	0	0	0	0	
	Red(1)	0	0	0	0	0	0	0	1	0	0	0	0	0	0	0	0	0	0	0	0	0	0	0	
	Red(2)	0	0	0	0	0	0	1	0	0	0	0	0	0	0	0	0	0	0	0	0	0	0	0	
	⋮	⋮	⋮	⋮	⋮	⋮	⋮	⋮	⋮	⋮	⋮	⋮	⋮	⋮	⋮	⋮	⋮	⋮	⋮	⋮	⋮	⋮	⋮	⋮	
	⋮	⋮	⋮	⋮	⋮	⋮	⋮	⋮	⋮	⋮	⋮	⋮	⋮	⋮	⋮	⋮	⋮	⋮	⋮	⋮	⋮	⋮	⋮	⋮	
	Red(253)	1	1	1	1	1	1	0	1	0	0	0	0	0	0	0	0	0	0	0	0	0	0	0	0
	Red(254)	1	1	1	1	1	1	1	0	0	0	0	0	0	0	0	0	0	0	0	0	0	0	0	0
	Red(255)	1	1	1	1	1	1	1	1	0	0	0	0	0	0	0	0	0	0	0	0	0	0	0	0
Gray Scale Of Green	Green(0) / Dark	0	0	0	0	0	0	0	0	0	0	0	0	0	0	0	0	0	0	0	0	0	0	0	
	Green(1)	0	0	0	0	0	0	0	0	0	0	0	0	0	0	1	0	0	0	0	0	0	0	0	
	Green(2)	0	0	0	0	0	0	0	0	0	0	0	0	0	1	0	0	0	0	0	0	0	0	0	
	⋮	⋮	⋮	⋮	⋮	⋮	⋮	⋮	⋮	⋮	⋮	⋮	⋮	⋮	⋮	⋮	⋮	⋮	⋮	⋮	⋮	⋮	⋮	⋮	
	⋮	⋮	⋮	⋮	⋮	⋮	⋮	⋮	⋮	⋮	⋮	⋮	⋮	⋮	⋮	⋮	⋮	⋮	⋮	⋮	⋮	⋮	⋮	⋮	
	Green(253)	0	0	0	0	0	0	0	0	1	1	1	1	1	1	0	1	0	0	0	0	0	0	0	0
	Green(254)	0	0	0	0	0	0	0	0	1	1	1	1	1	1	1	0	0	0	0	0	0	0	0	0
	Green(255)	0	0	0	0	0	0	0	0	1	1	1	1	1	1	1	1	0	0	0	0	0	0	0	0
Gray Scale Of Blue	Blue(0) / Dark	0	0	0	0	0	0	0	0	0	0	0	0	0	0	0	0	0	0	0	0	0	0	0	
	Blue(1)	0	0	0	0	0	0	0	0	0	0	0	0	0	0	0	0	0	0	0	0	0	0	1	
	Blue(2)	0	0	0	0	0	0	0	0	0	0	0	0	0	0	0	0	0	0	0	0	0	0	1	
	⋮	⋮	⋮	⋮	⋮	⋮	⋮	⋮	⋮	⋮	⋮	⋮	⋮	⋮	⋮	⋮	⋮	⋮	⋮	⋮	⋮	⋮	⋮	⋮	
	⋮	⋮	⋮	⋮	⋮	⋮	⋮	⋮	⋮	⋮	⋮	⋮	⋮	⋮	⋮	⋮	⋮	⋮	⋮	⋮	⋮	⋮	⋮	⋮	
	Blue(253)	0	0	0	0	0	0	0	0	0	0	0	0	0	0	0	1	1	1	1	1	1	1	0	1
	Blue(254)	0	0	0	0	0	0	0	0	0	0	0	0	0	0	0	1	1	1	1	1	1	1	1	0
	Blue(255)	0	0	0	0	0	0	0	0	0	0	0	0	0	0	0	1	1	1	1	1	1	1	1	1

Note (1) 0: Low Level Voltage, 1: High Level Voltage

4.5 DISPLAY TIMING SPECIFICATIONS

The input signal timing specifications are shown as the following table and timing diagram.

Signal	Item	Symbol	Min.	Typ.	Max.	Unit	Note
LVDS Clock	Frequency	Fc	45	54	69.3	MHz	-
	Period	Tc	14.43	18.52	22.22	ns	
	Input cycle to cycle jitter	T _{rcj}	-0.02*TC	---	0.02*TC	ns	(4)
	Input Clock to data skew	TLVCCS	-0.02*TC	---	0.02*TC	ns	(5)
	Spread spectrum modulation range	F _{ckin_mod}	0.97*FC	---	1.03*FC	MHz	(6)
	Spread spectrum modulation frequency	F _{SSM}			100	KHz	
Vertical Display Term	Frame Rate	Fr	50	60	75	Hz	
	Total	Tv	1044	1066	1450	Th	Tv=Tvd+Tvb-
	Active Display	Tvd		1024		Th	-
	Blank	Tvb	20	42		Th	-
Horizontal Display Term	Total	Th	790	844	880	Tc	Th=Thd+Thb
	Active Display	Thd		640		Tc	-
	Blank	Thb	150	204		Tc	-

Note: (1) Because this module is operated by DE only mode, Hsync and Vsync input signals are ignored.

(2) Please make sure the range of pixel clock has follow below equation:

$$F_c(\max) \geq Fr \times Tv \times Th$$

$$Fr \times Tv \times Th \geq F_c(\min)$$

(3) The Tv(Tvd+Tvb) must be integer, otherwise, this module would operate abnormally

INPUT SIGNAL TIMING DIAGRAM

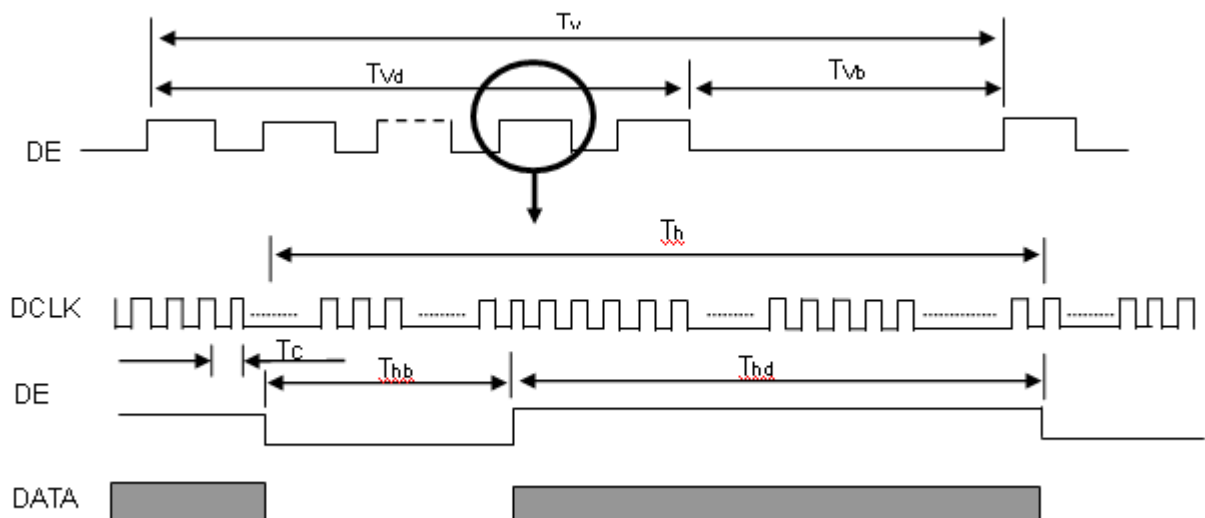

Note (4) The input clock cycle-to-cycle jitter is defined as below figures. $Trcl = |T_1 - T_1|$

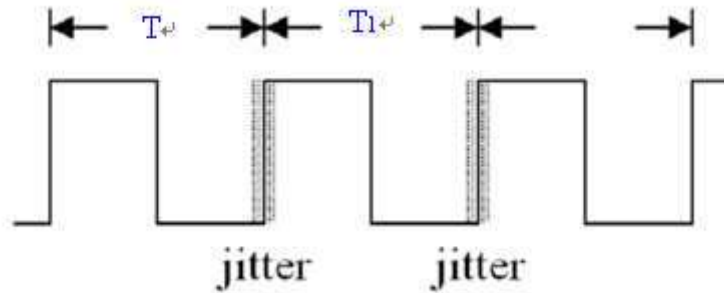

Note (5) Input Clock to data skew is defined as below figures.

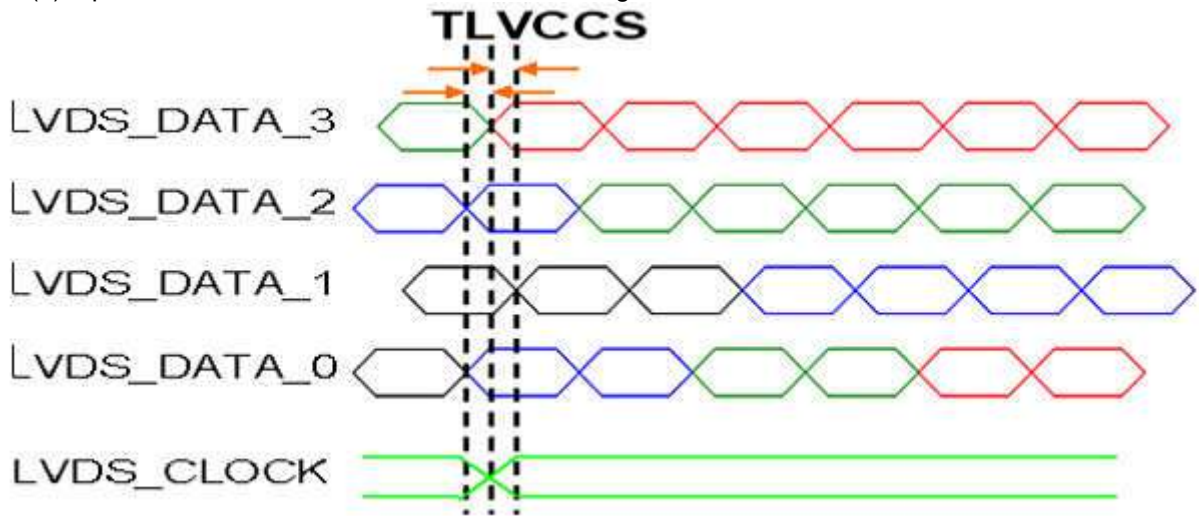

Note (6) The SSCG (Spread spectrum clock generator) is defined as below figures.

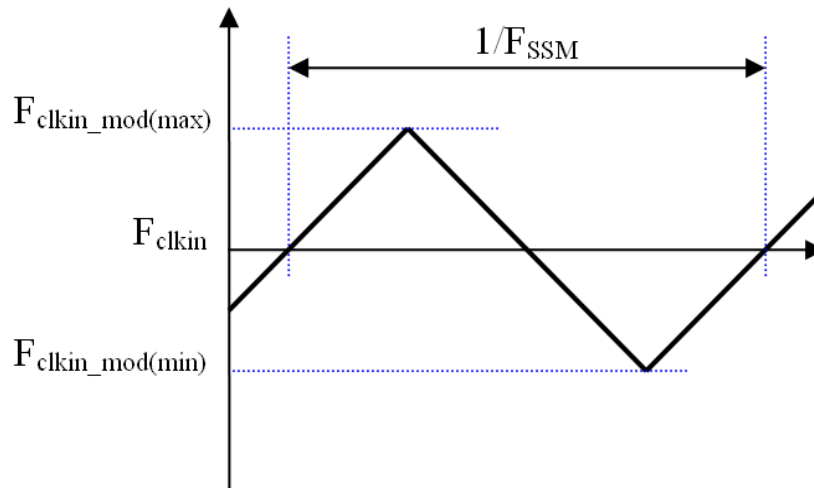

4.6 POWER ON/OFF SEQUENCE

The power sequence specifications are shown as the following table and diagram.

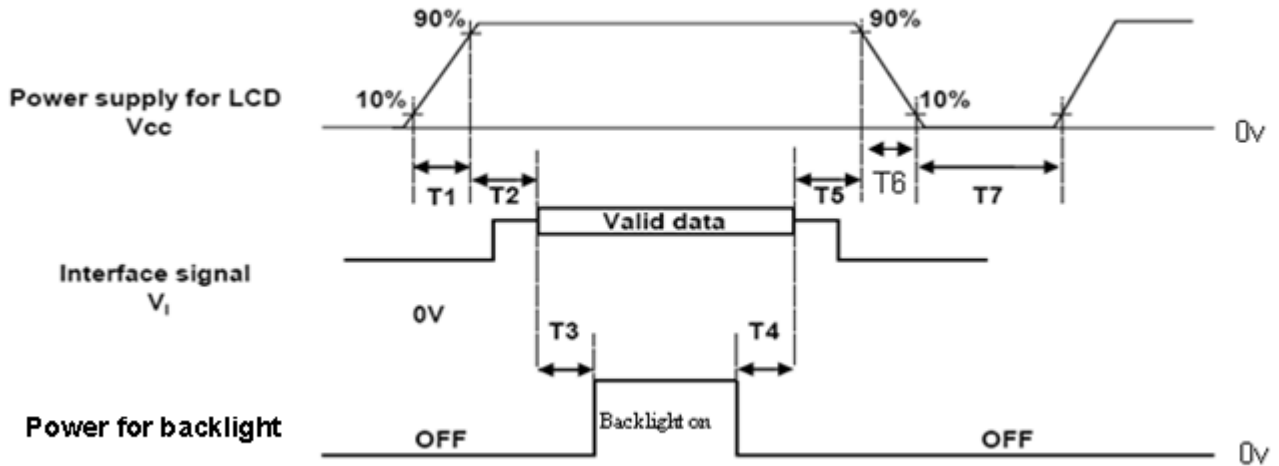

Timing Specifications:

Parameters	Values			Units
	Min	Typ.	Max	
T1	0.5	-	10	ms
T2	0	30	50	ms
T3	200	250	-	ms
T4	100	250	-	ms
T5	-	20	50	ms
T6	0.1	-	100	ms
T7	1000	-	-	ms

Note (1) The supply voltage of the external system for the module input should be the same as the definition of Vcc.

Note (2) When the backlight turns on before the LCD operation of the LCD turns off, the display may momentarily become abnormal screen.

Note (3) In case of VCC = off level, please keep the level of input signals on the low or keep a high impedance.

Note (4) T7 should be measured after the module has been fully discharged between power off and on period.

Note (5) Interface signal shall not be kept at high impedance when the power is on.

Note (6) CMI won't take any responsibility for the products which are damaged by the customers not following the Power Sequence.

Note (7) There might be slight electronic noise when LCD is turned off (even backlight unit is also off). To avoid this symptom, we suggest "Vcc falling timing" to follow "t6 spec".

5. OPTICAL CHARACTERISTICS

5.1 TEST CONDITIONS

Item	Symbol	Value	Unit
Ambient Temperature	Ta	25±2	°C
Ambient Humidity	Ha	50±10	%RH
Supply Voltage	According to typical value in "ELECTRICAL CHARACTERISTICS"		
Input Signal			
LED Light Bar Input Current Per Input Pin			
Input Pin			

5.2 OPTICAL SPECIFICATIONS

The relative measurement methods of optical characteristics are shown in 5.2. The following items should be measured under the test conditions described in 5.1 and stable environment shown in Note (5).

Item	Symbol	Condition	Min.	Typ.	Max.	Unit	Note					
Color Chromaticity (CIE 1931)	Red	Rx	$\theta_x=0^\circ, \theta_y=0^\circ$ CS-2000 R=G=B=255 Gray scale	Typ - 0.03	0.635	Typ + 0.03	(1), (5)					
		Ry			0.340							
	Green	Gx			0.312							
		Gy			0.626							
	Blue	Bx			0.158							
		By			0.058							
	White	Wx			0.313							
		Wy			0.329							
	Center Luminance of White (Center of Screen)	L _c						(350)	(400)	-	cd/m ²	(4), (5)
	Contrast Ratio	CR						700	1000	-	-	(2), (5)
Response Time	T _R	$\theta_x=0^\circ, \theta_y=0^\circ$	-	1	4	ms	(3)					
	T _F		-	4	6							
White Variation	W	$\theta_x=0^\circ, \theta_y=0^\circ$	75	80		%	(5), (6)					
Viewing Angle	Horizontal	$\theta_{x-} + \theta_{x+}$	CR ≥ 10	150	170	-	Deg.	(1), (5)				
	Vertical	$\theta_{y-} + \theta_{y+}$		140	160	-						
Viewing Angle	Horizontal	$\theta_{x-} + \theta_{x+}$	CR ≥ 5	160	178	---	Deg.	(1), (5)				
	Vertical	$\theta_{y-} + \theta_{y+}$		150	170	---						

Note (1) Definition of Viewing Angle (θ_x, θ_y):

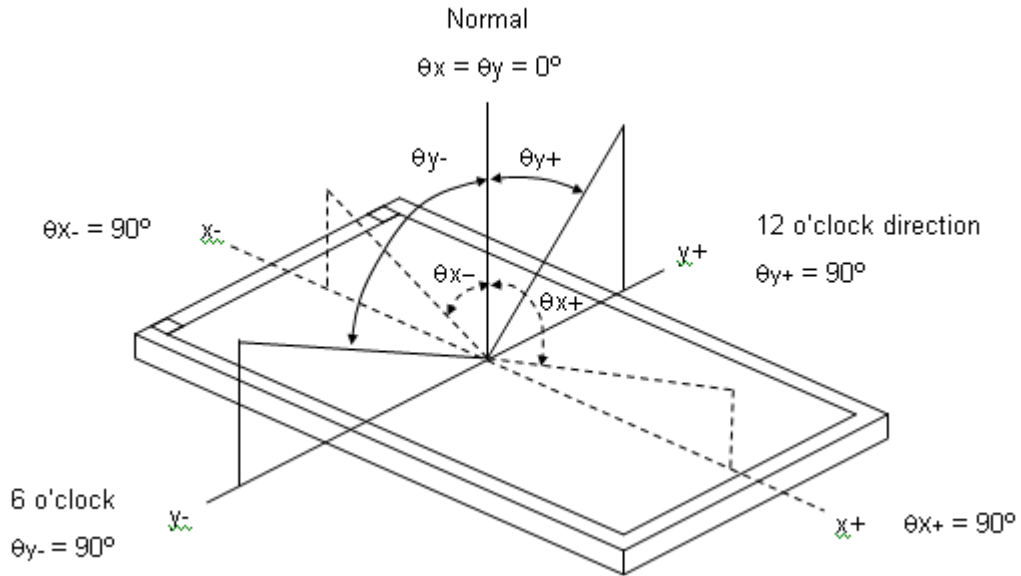

Note (2) Definition of Contrast Ratio (CR):

The contrast ratio can be calculated by the following expression.

$$\text{Contrast Ratio (CR)} = L_{255} / L_0$$

L255: Luminance of gray level 255

L 0: Luminance of gray level 0

$$CR = CR (5)$$

CR (X) is corresponding to the Contrast Ratio of the point X at Figure in Note (6).

Note (3) Definition of Response Time (T_R, T_F):

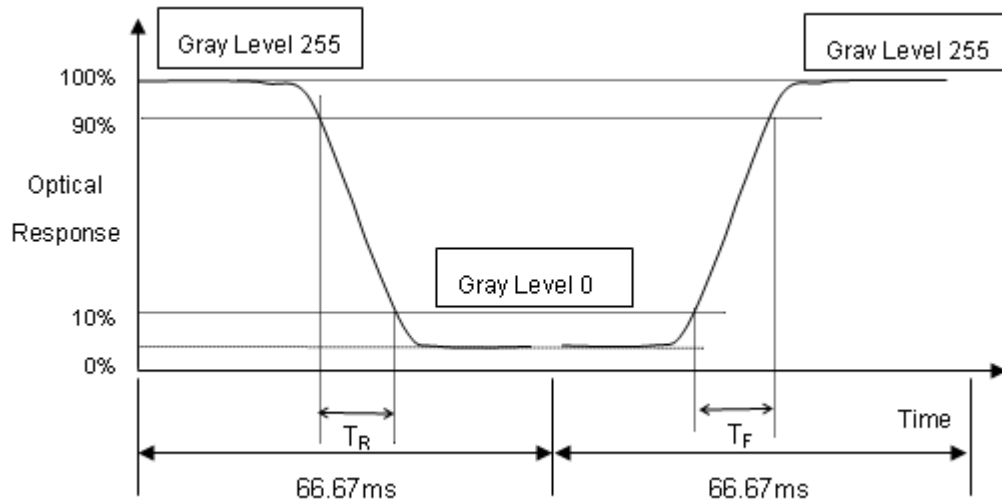

Note (4) Definition of Luminance of White (L_C):

Measure the luminance of gray level 255 at center point

$$L_C = L(5)$$

$L(x)$ is corresponding to the luminance of the point X at Figure in Note (6).

Note (5) Measurement Setup:

The LCD module should be stabilized at given temperature for 40 minutes to avoid abrupt temperature change during measuring. In order to stabilize the luminance, the measurement should be executed after lighting Backlight for 40 minutes in a windless room.

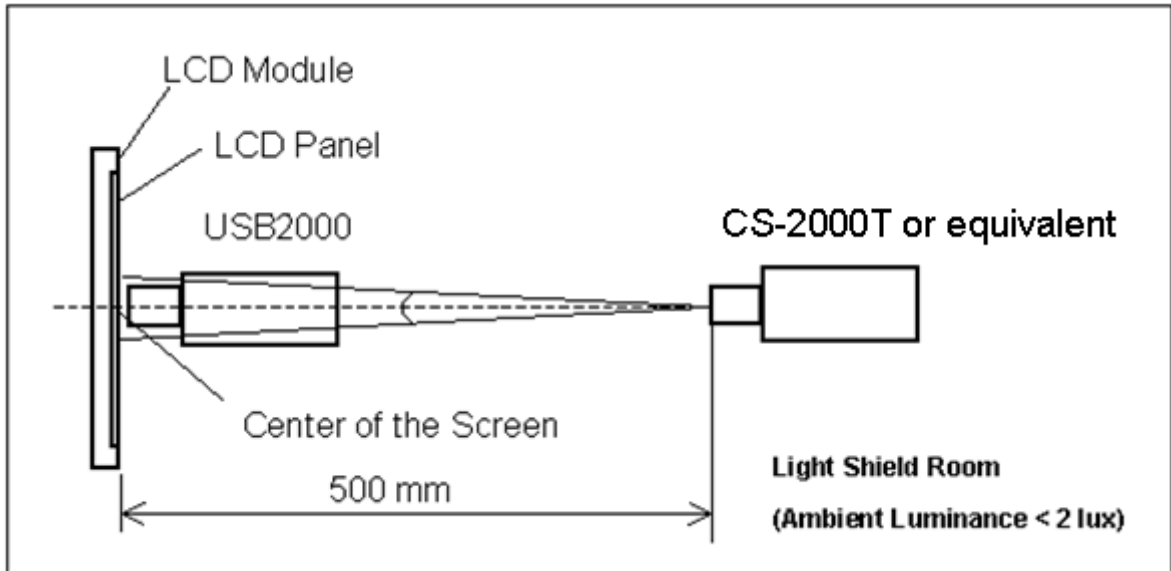

Note (6) Definition of White Variation (δW):

Measure the luminance of gray level 255 at 9 points

$$\delta W = (\text{Minimum } [L(1) \sim L(9)] / \text{Maximum } [L(1) \sim L(9)]) * 100\%$$

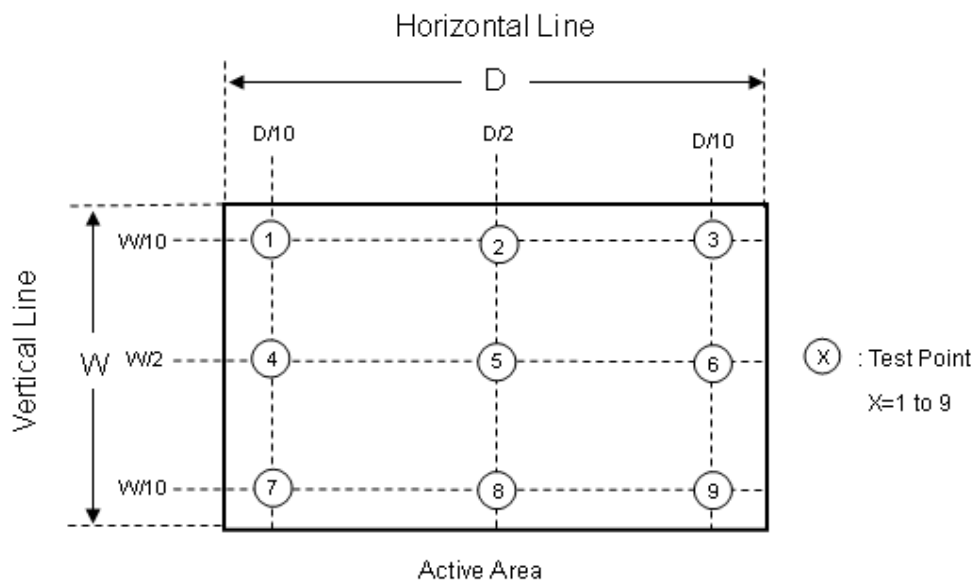

6. RELIABILITY TEST ITEM

Items	Required Condition	Note
Temperature Humidity Bias (THB)	Ta= 50°C , 80%RH, 240hours	(1) (2)
High Temperature Operation (HTO)	Ta= 50°C , 240hours	(1) (2)
Low Temperature Operation (LTO)	Ta= 0°C , 240hours	(1) (2)
High Temperature Storage (HTS)	Ta= 60°C , 240hours	(1) (2)
Low Temperature Storage (LTS)	Ta= -20°C , 240hours	(1) (2)
Vibration Test (Non-operation)	Acceleration: 1.5 G Wave: Half-sine Frequency: 10 - 300 Hz Sweep: 30 Minutes each Axis (X, Y, Z)	(3)
Shock Test (Non-operation)	Acceleration: 50 G Wave: Half-sine Active Time: 11 ms Direction : ± X, ± Y, ± Z.(one time for each Axis)	(3)
Thermal Shock Test (TST)	-20°C/30min , 60°C / 30min , 100 cycles	(1) (2)
On/Off Test	25°C , On/10sec , Off /10sec , 30,000 cycles	(1) (2)
ESD (Electro Static Discharge)	Contact Discharge: ± 8KV, 150pF(330Ω)	(1)
	Air Discharge: ± 15KV, 150pF(330Ω)	(1)
Altitude Test	Operation:16,404 ft / 24hours	(1) (2)
	Non-Operation:30,000 ft / 24hours	

Note (1) criteria : Normal display image with no obvious non-uniformity and no line defect.

Note (2) Evaluation should be tested after storage at room temperature for more than two hour

Note (3) At testing Vibration and Shock, the fixture in holding the module has to be hard and rigid enough so that the module would not be twisted or bent by the fixture.

The fixing condition is shown as below:

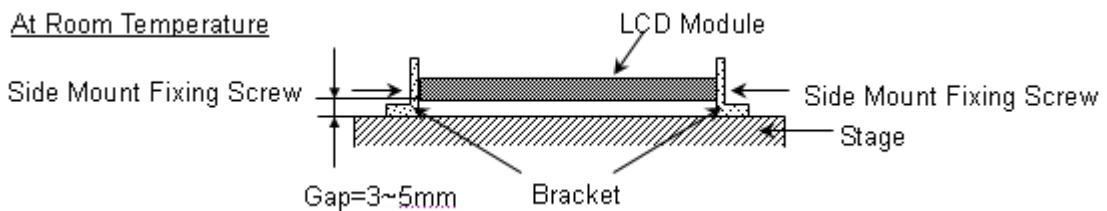

7. Mechanical Strength Characteristics

7.1 Mechanical Strength Specifications

Item	Condition	Min	Unit	Note
Mechanical Strength	128 th Gray Pattern	0.6	Kgf	

7.2 Test Conditions

Items	Description
Test Condition	1. Ambient Illumination : 10~15 lux 2. Test Pattern : 128 Gray 3. Distance of the judgment : 30cm from the surface of module 4. Viewing angle of the judgment : Front
Gage Information	1. Push pull guage a. Model name : HF-50, maker : ALGOL b. Shape of gage tip - Diameter : 2mm - Thickness : 2mm
Definition of Minimum force	To measure minimum force when operator detects any white spot and light leakage that have occurred while operator presses on back side of module with push pull gage.

7.3 Definition of Test Points

Measure the minimum force of test points at 128th Gray pattern. The test points at back side of module area is showing as below (except PCBA).

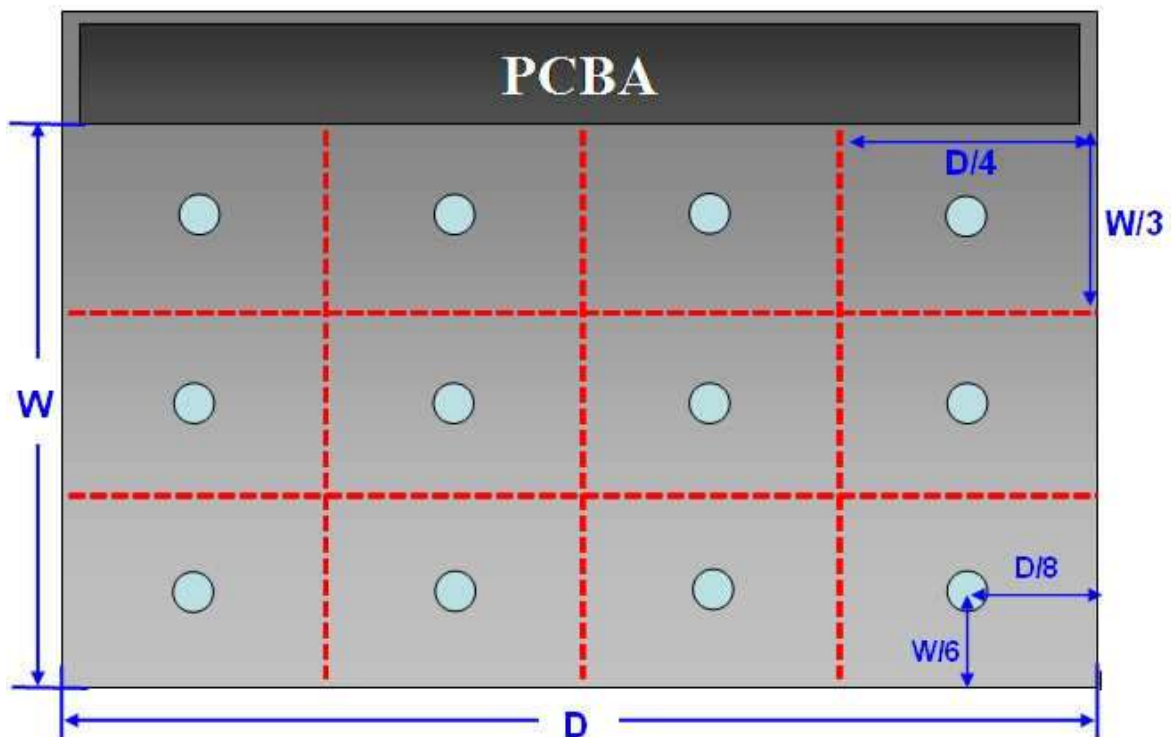

8. PACKING

8.1 PACKING SPECIFICATIONS

- (1) 11 LCD modules / 1 Box
- (2) Box dimensions: 440(L) X 280 (W) X 375(H) mm
- (3) Weight: approximately: 17.45kg (11 modules per box)

8.2 PACKING METHOD

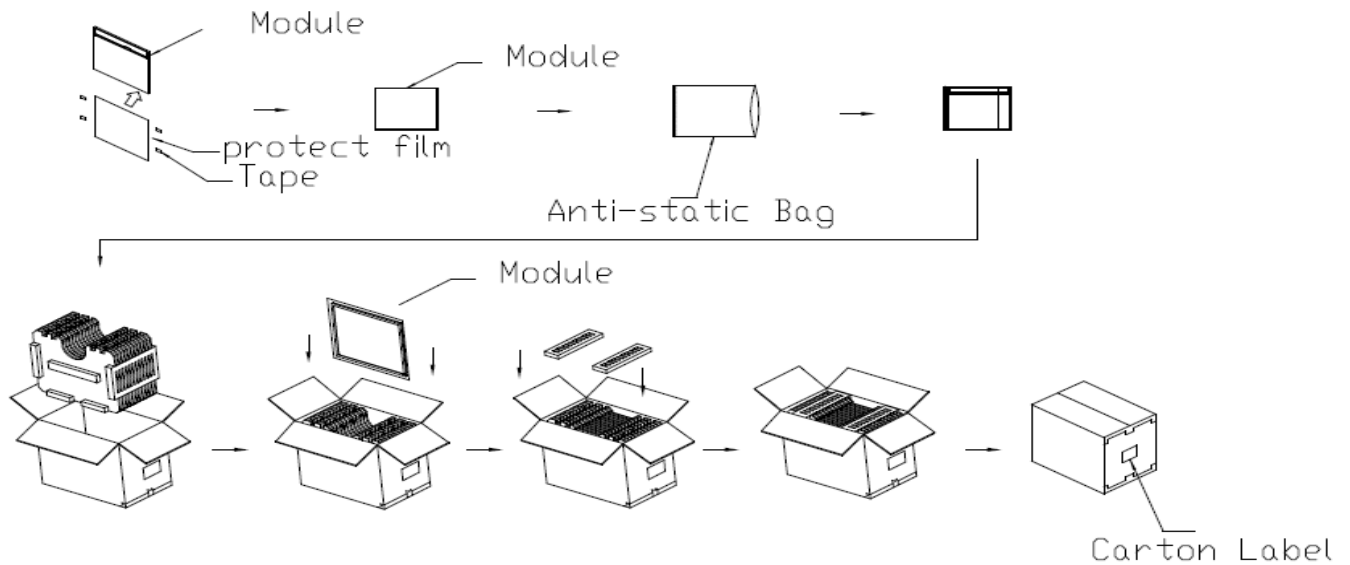
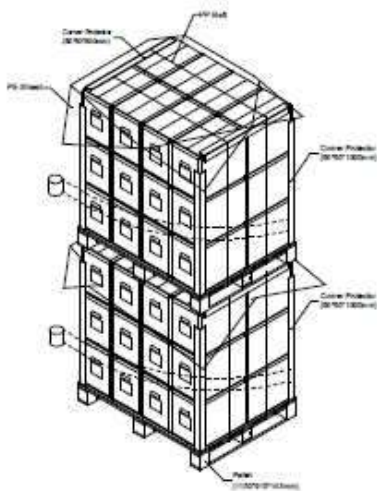

Figure. 7-1 Packing method

8.3 PALLET

棧板堆疊包膜型式

Sea / Land Transportation (40ft HQ Container)



Sea / Land Transportation (40ft Container)

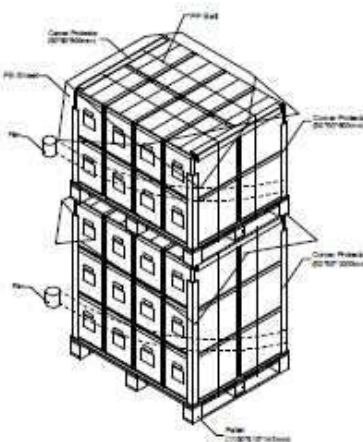

Air Transportation

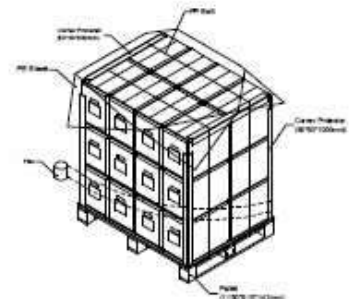

9. INX MODULE LABEL

The barcode nameplate is pasted on each module as illustration, and its definitions are as following explanation.



- (a) Model Name: M170EGE-L50
- (b) Revision: Rev. XX, for example: A0, A1... B1, B2... or C1, C2...etc.
- (c) Innolux barcode definition:
Serial ID: XX-XX-X-XX-YMD-L-NNNN

Code	Meaning	Description
XX	INX internal use	-
XX	Revision	Cover all the change
X	INX internal use	-
XX	INX internal use	-
YMD	Year, month, day	Year: 2001=1, 2002=2, 2003=3, 2004=4... Month: 1~12=1, 2, 3, ~, 9, A, B, C Day: 1~31=1, 2, 3, ~, 9, A, B, C, ~, W, X, Y, exclude I, O, and U.
X	INX internal use	Grade Code
NNNN	Serial number	Manufacturing sequence of product

10. PRECAUTIONS

10.1 ASSEMBLY AND HANDLING PRECAUTIONS

- (1) Do not apply rough force such as bending or twisting to the module during assembly.
- (2) To assemble or install module into user's system can be only in clean working areas. The dust and oil may cause electrical short or worsen the polarizer.
- (3) It's not permitted to have pressure or impulse on the module because the LCD panel and Backlight will be damaged.
- (4) Always follow the correct power sequence when LCD module is connecting and operating. This can prevent damage to the CMOS LSI chips during latch-up.
- (5) Do not pull the I/F connector in or out while the module is operating.
- (6) Do not disassemble the module.
- (7) Use a soft dry cloth without chemicals for cleaning, because the surface of polarizer is very soft and easily scratched.
- (8) It is dangerous that moisture come into or contacted the LCD module, because moisture may damage LCD module when it is operating.
- (9) High temperature or humidity may reduce the performance of module. Please store LCD module within the specified storage conditions.
- (10) When ambient temperature is lower than 10°C may reduce the display quality. For example, the response time will become slowly.

10.2 STORAGE PRECAUTIONS

- (1) Do not leave the module in high temperature, and high humidity for a long time. It is highly recommended to store the module with temperature from 0°C to 35°C and relative humidity of less than 70%
- (2) Do not store the TFT – LCD module in direct sunlight
- (3) The module should be stored in dark place. It is prohibited to apply sunlight or fluorescent light in storing

10.3 OPERATION PRECAUTIONS

- (1) The LCD product should be operated under normal condition.
Normal condition is defined as below :
Temperature : 20±15°C
Humidity: 65±20%
Display pattern : continually changing pattern(Not stationary)
- (2) If the product will be used in extreme conditions such as high temperature, high humidity, high altitude, display pattern or operation time etc... It is strongly recommended to contact CMI for application engineering advice. Otherwise, its reliability and function may not be guaranteed.

10.4 SAFETY PRECAUTIONS

- (1) If the liquid crystal material leaks from the panel, it should be kept away from the eyes or mouth. In case of contact with hands, skin or clothes, it has to be washed away thoroughly with soap.
- (2) After the module's end of life, it is not harmful in case of normal operation and storage.

10.5 SAFETY STANDARDS

The LCD module should be certified with safety regulations as follows:

- (1) UL60950-1 or updated standard.
- (2) IEC60950-1 or updated standard.

10.6 OTHER

When fixed patterns are displayed for a long time, remnant image is likely to occur.

REV	DATE	DESCRIPTION
1	2018/07/05	Final Release

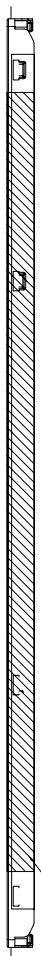

Data Chip Position
(SI mechanical structure should not touch the position of data chip)

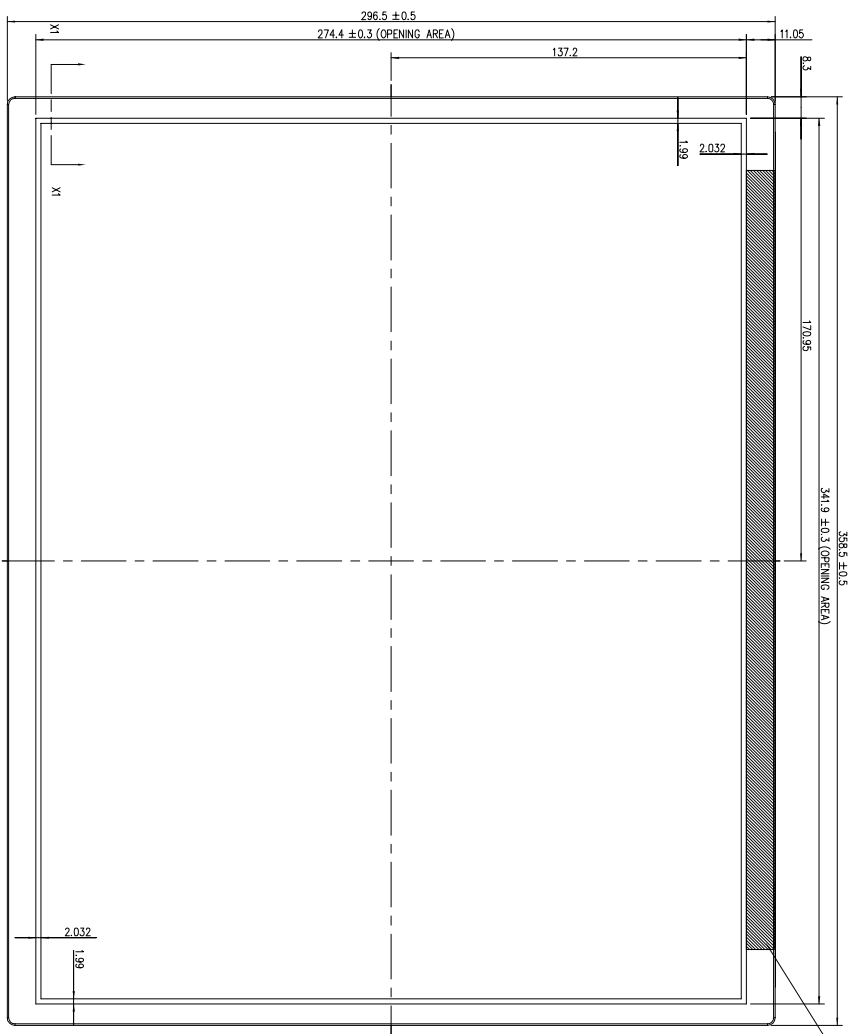
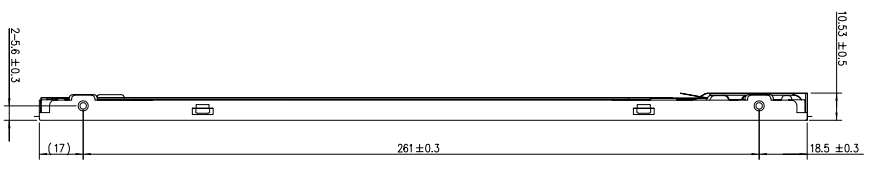

Data Chip Position
(SI mechanical structure should not touch the position of data chip)

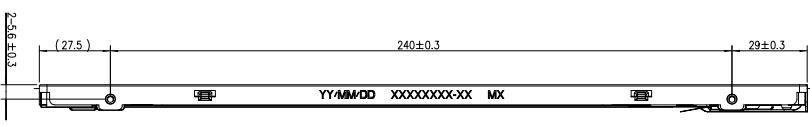

- NOTES:
1. UNSPECIFIED TOLERANCE: ±0.5mm
 2. UNLESS SPECIFIED OTHERWISE, ALL DIMENSIONS ARE IN MILLIMETERS
 3. MINIMUM FORCE TO OPEN: 10N (MAX)
 4. SIDE MOUNT HOLE TORQUE: 4kg-cm (MAX)

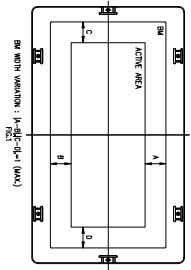
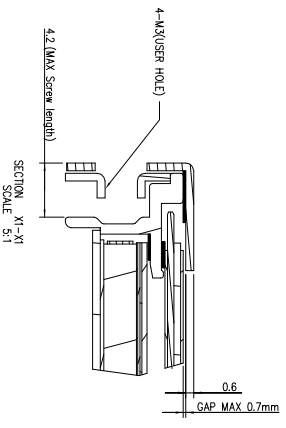

SYMBOL	DESCRIPTION	DATE	BY	CHK
APPROVED	31	2018/07/05		
DESIGN	MSH	2018/07/05		
DESIGN	ESR	2018/07/05		

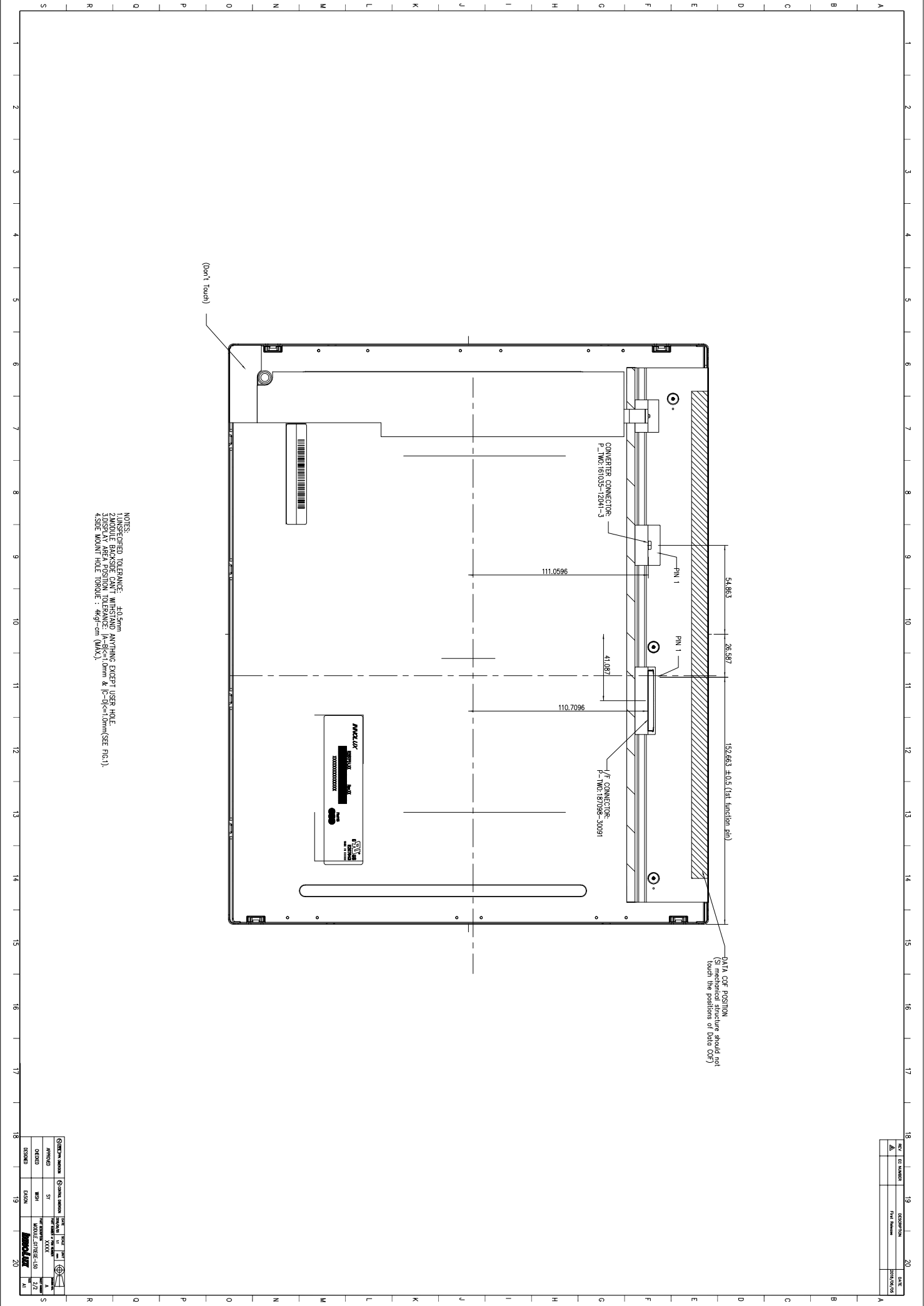

NOTES:
 1. UNSPECIFIED TOLERANCE: ±0.5mm
 2. MODULE BACKSIDE CANNOT WITHSTAND ANYTHING EXCEPT USER HOLE.
 3. USER HOLE POSITION: CENTER OF HOLE ±0.5mm & R=0<-1.0mm(SEE FIG.1).
 4. SIDE MOUNT HOLE TORQUE: 0.9N·m (MAX).

DATA COP POSITION
 (SI mechanical structure should not touch the positions of Data COP)

REV	EC NUMBER	DESCRIPTION	DATE
1		Final Release	2007/07/05

APPROVED	SY	DATE	2007/07/05
DESIGN	MSH	DATE	2007/07/05
CHECK	ESD	DATE	2007/07/05