

# AU OPTRONICS CORPORATION

## Product Specification

### 17.0" WXGA Color TFT-LCD Module

**Model Name: M170XW01 V.2**

Approved by	Prepared by

*AU Optronics corporation*

Customer	Checked & Approved by

## Product Specification

### 17.0" WXGA Color TFT-LCD Module Model Name: M170XW01 V.2

Preliminary Specifications  
 Final Specifications

Note: This Specification is subject to change without notice.

# Contents

<b>1.0 Handling Precautions .....</b>	<b>6</b>
<b>2.0 General Description .....</b>	<b>7</b>
2.1 Display Characteristics.....	7
2.2 Optical Characteristics .....	8
<b>3.0 Functional Block Diagram.....</b>	<b>11</b>
<b>4.0 Absolute Maximum Ratings .....</b>	<b>12</b>
<b>5.0 Electrical characteristics .....</b>	<b>13</b>
5.1 TFT LCD Module.....	13
5.1.1 Power Specification.....	13
5.1.2 Signal Electrical Characteristics.....	14
5.2 Backlight Unit .....	15
<b>6.0 Signal Characteristic .....</b>	<b>16</b>
6.1 Pixel Format Image.....	16
6.2 The input data format .....	16
6.3 Signal Description.....	17
6.4 Interface Timings.....	18
6.4.1 Timing Characteristics.....	18
6.4.2 Timing diagram .....	19
6.5 Power ON/OFF Sequence .....	20
<b>7.0 Connector &amp; Pin Assignment.....</b>	<b>21</b>
7.1 TFT LCD Module.....	21
7.2 Backlight Unit .....	21
<b>8.0 Vibration, Shock, and Drop.....</b>	<b>22</b>
8.1 Vibration & Shock .....	22
8.2 Drop test .....	22
<b>9.0 Environment .....</b>	<b>22</b>
9.1 Temperature and Humidity .....	22
9.1.1 Operating Conditions .....	22
9.1.2 Shipping Conditions.....	22
9.2 Atmospheric Pressure .....	23
9.3 Thermal Shock .....	23
<b>10.0 Reliability.....</b>	<b>23</b>
10.1 Failure Criteria .....	23
10.2 Failure Rate.....	23
10.2.1 Usage.....	23

**11.0 Safety .....23**

- 11.1 Sharp Edge Requirements ..... 23
- 11.2 Materials ..... 24
  - 11.2.1 Toxicity ..... 24
  - 11.2.2 Flammability ..... 24
- 11.3 Capacitors ..... 24

**12.0 Other requirement .....24**

- 12.1 National Test Lab Requirement ..... 24
- 12.2 Label ..... 24

**13.0 Mechanical Characteristics .....25**

## Record of Revision

Version and Date	Page	Old description	New Description	Remark
0.1 2004/03/26	All	First Edition for Customer	All	
0.2 2004/05/24	13	IDD (Typ= TBD, Max= TBD)	IDD (Typ= 950, Max= 1200 mA)	Update
	13	Irush= (Max= TBD)	Irush= (Max= 3.0 A)	Update
	13	PDD (Typ= TBD, Max= TBD)	PDD (Typ= 4.75, Max= 6.6 W)	Update
	18	Data CLK(Min= 35, Max= 83MHz) H-Period (Min= 1320 Tclk) V-Period (Max= 823 Th) Frame Rate (Max= 80Hz)	Data CLK(Min= 45, Max= 81MHz) H-Period (Min= 1330 Tclk) V-Period (Max= 860 Th) Frame Rate (Max= 75Hz)	Update
	20	Power ON/OFF Sequence T1 (Min= NA) ; T6 (Min= NA)	Power ON/OFF Sequence T1 (Min=0.5 ms) ; T6 (Min=0.5 ms)	Update
0.3 2004/05/27	15	LTCFL (Min= 30,000 Hours) (Typ= NA)	LTCFL (Min= 25,000 Hours) (Typ= 35,000 Hours)	Update
0.4 2004/07/02	15	LTCFL (Min= 30,000 Hours) (Typ= NA)	LTCFL (Min= 25,000 Hours) (Typ= 35,000 Hours)	Update
0.5 2004/07/29	08	Brightness uniformity Min= 75%, Typ= 80%	Brightness uniformity Min= 70%, Typ= 75%	Update

## 1.0 Handling Precautions

- 1) Since front polarizer is easily damaged, pay attention not to scratch it.
- 2) Be sure to turn off power supply when inserting or disconnecting from input connector.
- 3) Wipe off water drop immediately. Long contact with water may cause discoloration or spots.
- 4) When the panel surface is soiled, wipe it with absorbent cotton or other soft cloth.
- 5) Since the panel is made of glass, it may break or crack if dropped or bumped on hard surface.
- 6) Since CMOS LSI is used in this module, take care of static electricity and insure human earth when handling.
- 7) Do not open nor modify the Module Assembly.
- 8) Do not press the reflector sheet at the back of the module to any directions.
- 9) In case if a module has to be put back into the packing container slot after once it was taken out from the container, do not press the center of the CCFL reflector edge. Instead, press at the far ends of the CCFL reflector edge softly. Otherwise the TFT module may be damaged.
- 10) At the insertion or removal of the Signal Interface Connector, be sure not to rotate nor tilt the Interface Connector of the TFT module.
- 11) After installation of the TFT module into an enclosure (Desktop monitor Bezel, for example), do not twist nor bend the TFT Module even momentary. At designing the enclosure, it should be taken into consideration that no bending/twisting forces are applied to the TFT module from outside. Otherwise the TFT module may be damaged.

## 2.0 General Description

This specification applies to the 17.0 inch Color TFT/LCD Module M170XW01 V.2. This module is designed for a display unit of personal computer. The display supports the WXGA (1280(H) x 768(V)) screen format and 16.2M colors (RGB 6-bits + FRC data). All input signals are 1 Channel LVDS interface compatible. This module does not contain an inverter card for backlight.

## 2.1 Display Characteristics

The following items are characteristics summary on the table under 25 °C condition:

ITEMS	Unit	SPECIFICATIONS			
Screen Diagonal	[mm]	432(17.0" Wide)			
Active Area	[mm]	370.56 (H) x 222.34(V)			
Pixels H x V		1280(x3) x 768			
Pixel Pitch	[mm]	0.2895 (per one triad) x 0.2895			
Pixel Arrangement		R.G.B. Vertical Stripe			
Display Mode		Normally Black			
White Luminance	[cd/m <sup>2</sup> ]	450 (Typ, Center @ Lamp= 11.0mA)			
Contrast Ratio		800 : 1			
Optical Response Time (Gray to Gray)	[msec]	16 (Typ)			
Nominal Input Voltage VDD	[Volt]	+5.0 V			
Power Consumption (VDD line + CCFL line)	[Watt]	TBD W(Typ) (PDD=TBD W, PCFL=TBD W @Lamp=11.0mA)			
Weight	[Grams]	2000 (Typ)			
Physical Size	[mm]		Min.	Typ.	Max.
		Horizatal(H)	403.5	404.0	404.5
		Vertical(V)	248.0	248.5	249.0
		Depth(D)	16.8	17.3	17.8
Electrical Interface		1 Channel LVDS			
Support Color		16.2M colors (RGB 6-bit + FRC data)			
Surface treatment		Glare type, hard coating (2H)			
Temperature Range					
Operating	[°C]	0 to +50			
Storage (Shipping)	[°C]	-20 to +60			

## 2.2 Optical Characteristics

The optical characteristics are measured under stable conditions at 25°C:

Item	Unit	Conditions	Min.	Typ.	Max.	Note
Viewing Angle	[degree]	Horizontal (Right)	75	85	-	
		CR = 10 (Left)	75	85	-	
		Vertical (Up)	75	85	-	
		CR = 10 (Down)	75	85	-	
Contrast ratio		Normal Direction	600	800	-	
Response Time	[msec]	Rasing Time	-	15	25	<b>Note 1</b>
		Falling Time	-	10	15	
		Raising + Falling	-	25	40	
		Gray to Gray	-	16	-	
Color / Chromaticity Coordinates (CIE)		Red x	0.61	0.64	0.67	
		Red y	0.31	0.34	0.37	
		Green x	0.26	0.29	0.32	
		Green y	0.58	0.61	0.64	
		Blue x	0.11	0.14	0.17	
		Blue y	0.04	0.07	0.10	
Color Coordinates (CIE) White		White x	0.28	0.31	0.34	
		White y	0.30	0.33	0.36	
White Luminance @ CCFL 11.0mA (Center)	[cd/m <sup>2</sup> ]		400	450	-	
Luminance Uniformity	[%]		70	75		<b>Note 2</b>
Crosstalk (in 75Hz)	[%]		-	-	1.5	<b>Note 3</b>
Flicker	dB		-	-	-20	<b>Note 4</b>

**Equipment:** Pattern Generator, Power Supply, Digital Voltmeter, Luminance meter  
(PR 880, BM-5A / BM7)

Aperture 1° with 100cm VD or 2° with 50cm viewing distance

Test Point Center (VESA point 9)

Environment < 1 lux

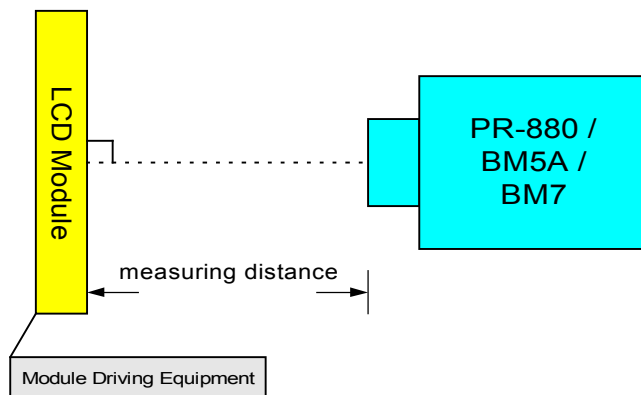



**Note 1: The Definition of Response time**

The output signals of photodetector are measured when the input signals are changed from “Black” to “White” (rising time), and from “White” to “Black ”(falling time), respectively. The response time is interval between the 10% and 90% of amplitudes.

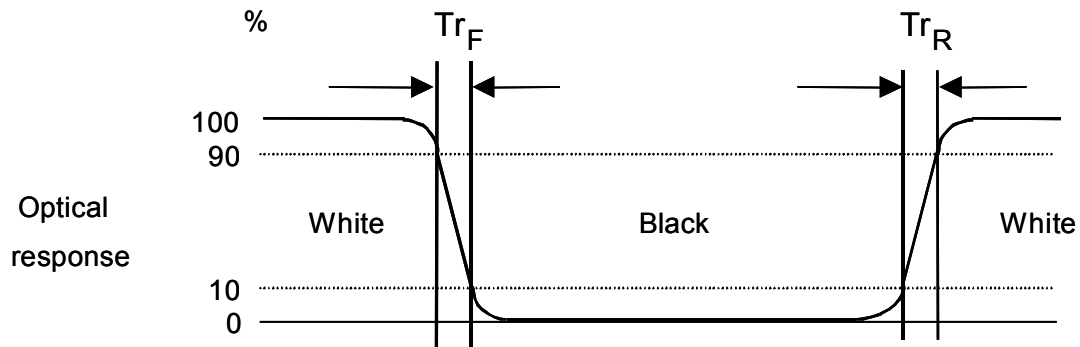

**Note 2: Brightness uniformity of these 9 points is defined as below**

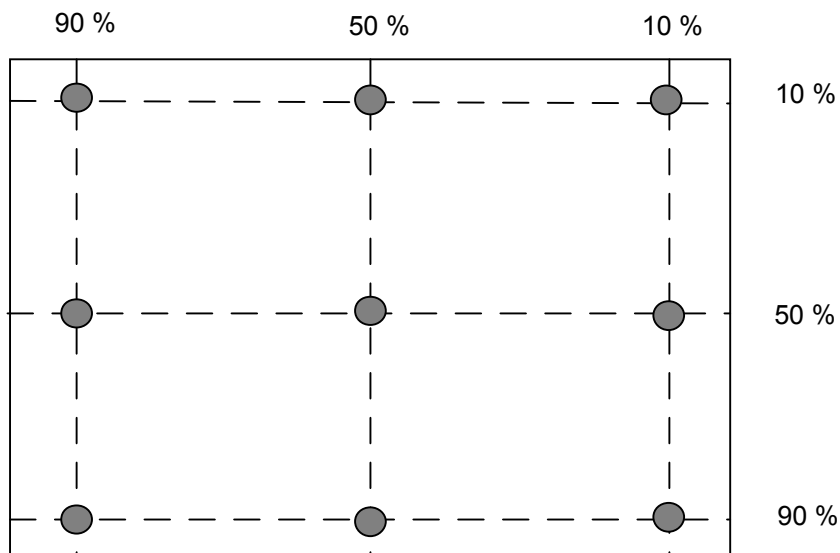

$$\text{Uniformity} = \frac{\text{Minimum Luminance in 9 points (1-9)}}{\text{Maximum Luminance in 9 Points (1-9)}}$$

**Note 3: The Definition of Crosstalk**

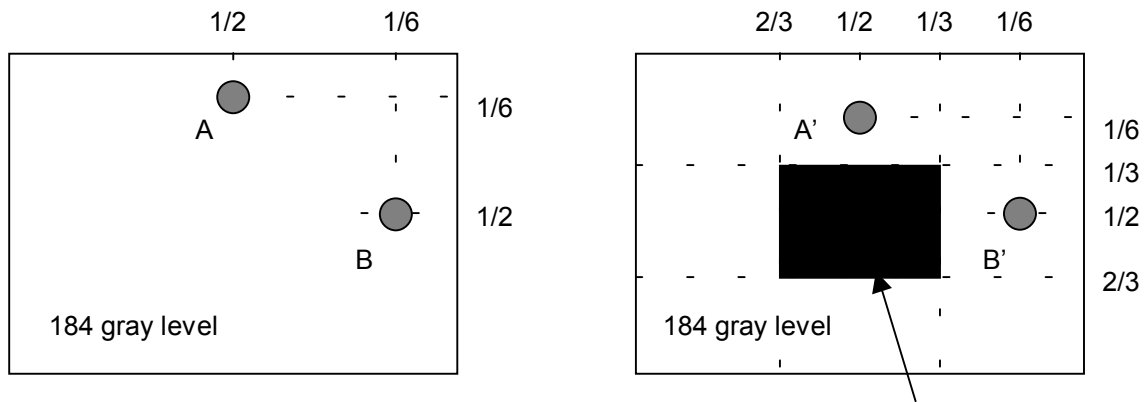

Unit: percentage of dimension of display area

$|L_A - L_{A'}| / L_A \times 100\% = 1.5\% \text{ max.}$ ,  $L_A$  and  $L_B$  are brightness at location A and B

$|L_B - L_{B'}| / L_B \times 100\% = 1.5\% \text{ max.}$ ,  $L_{A'}$  and  $L_{B'}$  are brightness at location A' and B'

**Note4: The Definition of Flicker**

Test Pattern: Subchecker Pattern

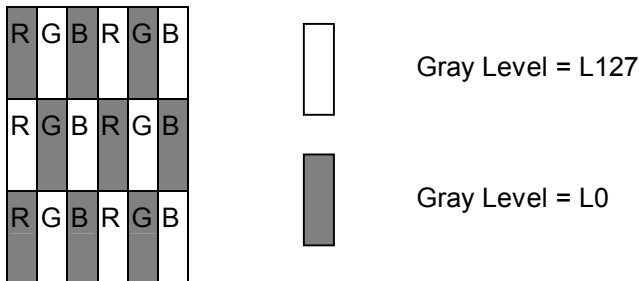

Method: Record dBV & DC value with (WESTAR)TRD-100

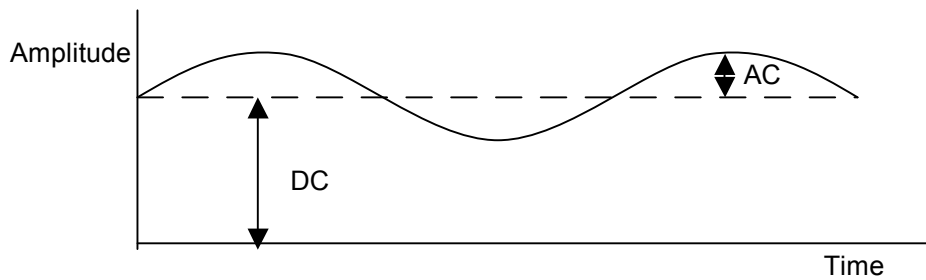

$$\text{Flicker (dB)} = 20 \log \frac{\text{AC Level(at 30 Hz)}}{\text{DC Level}}$$



### 4.0 Absolute Maximum Ratings

Absolute maximum ratings of the module is as following:

#### TFT LCD Module

Item	Symbol	Min	Max	Unit	Conditions
Logic/LCD Drive	VIN	-0.3	+5.5	[Volt]	<b>Note 1,2</b>

#### Backlight Unit

Item	Symbol	Min	Max	Unit	Conditions
CCFL Current	ICFL	-	12.0	[mA] rms	<b>Note 1,2</b>
CCFL Frequency	FCFL	40	80	[Hz]	<b>Note 1,2</b>

#### Absolute Ratings of Environment

Item	Symbol	Min	Max	Unit	Conditions
Operating Humidity	HOP	8	95	[%RH]	
Storage Temperature	TST	-20	+60	[°C]	
Storage Humidity	HST	8	95	[%RH]	

**Note 1:** With in Ta (25°C )

**Note 2:** Permanent damage to the device may occur if exceed maximum values

#### Relative Humidity %

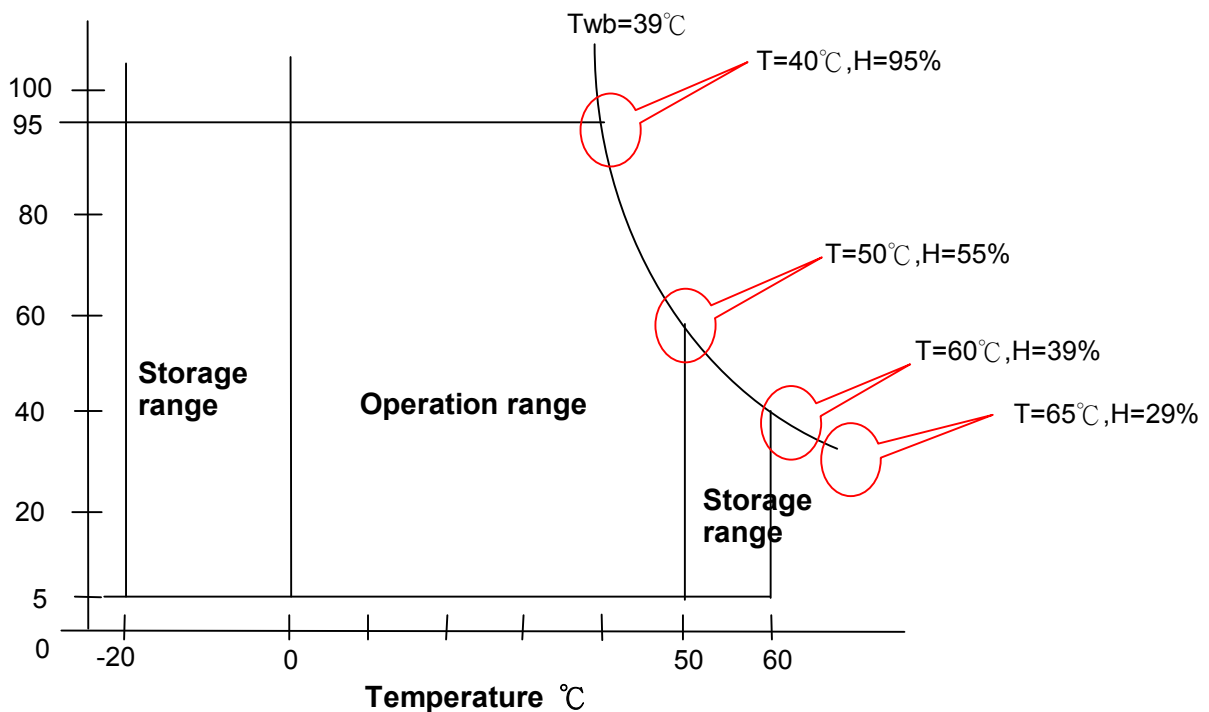

## 5.0 Electrical characteristics

### 5.1 TFT LCD Module

#### 5.1.1 Power Specification

Input power specifications are as follows;

Symbol	Parameter	Min	Typ	Max	Units	Condition
VDD	Logic/LCD Drive Voltage	4.5	5	5.5	[Volt]	±10%
IDD	VDD current	-	950	1200	[mA]	Vin=5V , All White Pattern, +30%, at 75Hz
Irush	LCD Inrush Current	-	-	3.0	[A]	<b>Note</b>
PDD	VDD Power	-	4.75	6.6	[Watt]	Vin=5V , All White Pattern, +30%, at 75Hz
VDDrp	Allowable Logic/LCD Drive Ripple Voltage			100	[mV] p-p	

**Note:** Measurement conditions:

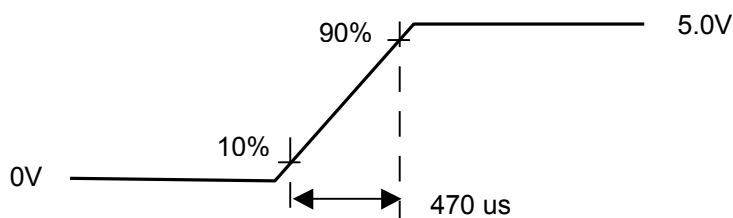
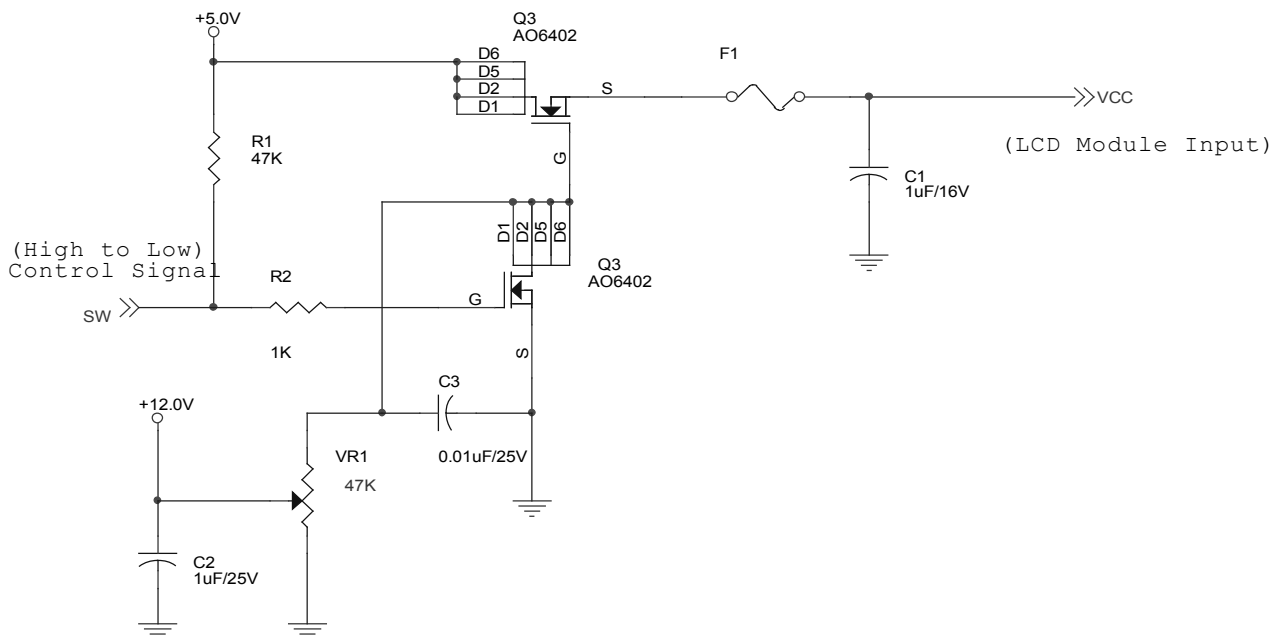

**Vin rising time**

### 5.1.2 Signal Electrical Characteristics

Each signal characteristics are as follows;

Symbol	Parameter	Min	Typ	Max	Units	Condition
VTH	Differential Input High Threshold	-	-	+100	[mV]	VICM = 1.2V <b>Note</b>
VTL	Differential Input Low Threshold	-100	-	-	[mV]	VICM = 1.2V <b>Note</b>
VID	Input Differential Voltage	100	400	600	[mV]	<b>Note</b>
VICM	Differential Input Common Mode Voltage	1.1	-	1.45	[V]	VTH/VTL = $\pm 100$ MV <b>Note</b>

**Note:** LVDS Signal Waveform

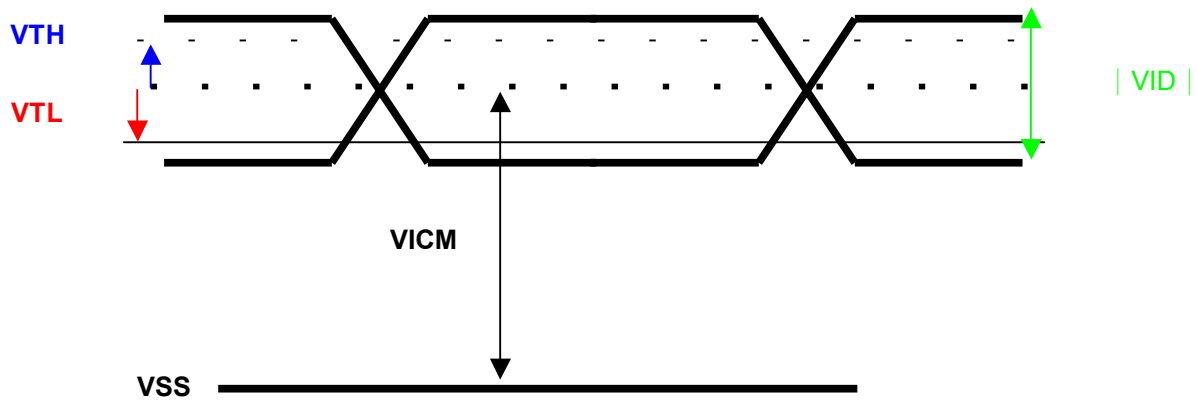

## 5.2 Backlight Unit

Parameter guideline for CCFL Inverter

Symbol	Parameter	Min.	Typ.	Max.	Unit	Condition
ISCFL	CCFL standard current	10.5	11.0	11.5	[mA] rms	(Ta=25°C) <b>Note 1</b>
IRCFL	CCFL operation range	5.5	11.0	12.0	[mA] rms	(Ta=25°C)
FCFL	CCFL Frequency	40	60	80	[KHz]	(Ta=25°C) <b>Note 2</b>
ViCFL (0°C)	CCFL Ignition Voltage (End of the lamp wire connector)	1650	-	-	[Volt] rms	(Ta=0°C)
ViCF (25°C)	CCFL Ignition Voltage (End of the lamp wire connector)	1250	-	-	[Volt] rms	(Ta=25°C)
VCFL	CCFL Operation Voltage	-	560 @11.0mA	680 @5.5mA	[Volt] rms	(Ta=25°C) <b>Note 3</b>
PCFL	CCFL Power consumption (for reference)	-	24.6	28	[Watt]	(Ta=25°C) <b>Note 4</b>
LTCFL	CCFL life Time	25,000	35,000	-	[Hour]	(Ta=25°C) <b>Note 5</b>

**Note 1:** CCFL standard current is measured at 25±2°C. The variance of the current is ±10%.

**Note 2:** CCFL Frequency should be carefully determined to avoid interference between inverter and TFT LCD

**Note 3:** CCFL operation voltage is measured at 25±2°C.

**Note 4:** The variance of CCFL power consumption is ±10%. Calculator value for reference

(ICFL×VCFL×4=PCFL).

**Note 5:** CCFL life time is determined as the time at which brightness of lamp is 50%. The typical life time of CCFL is on the condition at 11.0mA lamp current.

## 6.0 Signal Characteristic

### 6.1 Pixel Format Image

Following figure shows the relationship of the input signals and LCD pixel format.

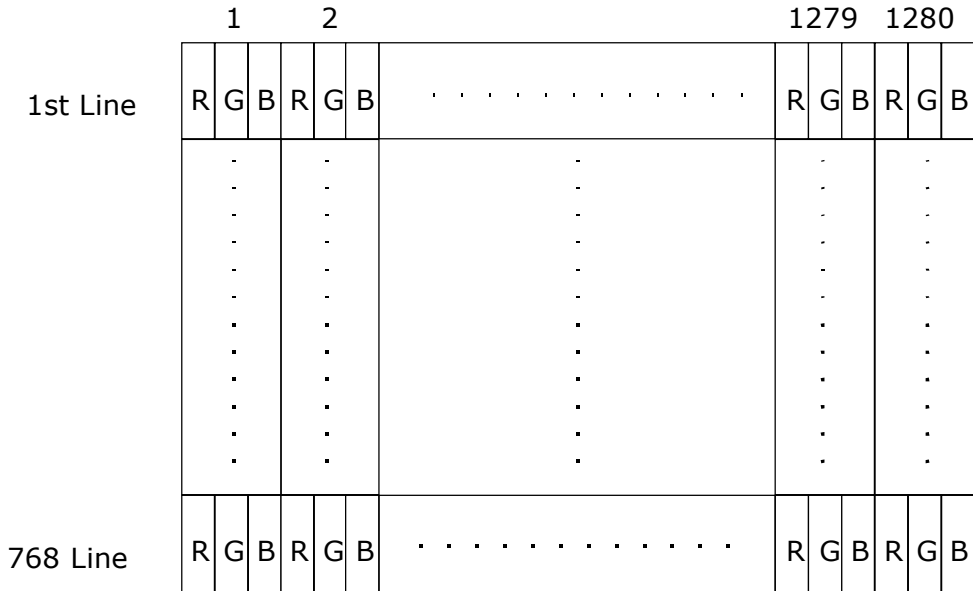

### 6.2 The input data format

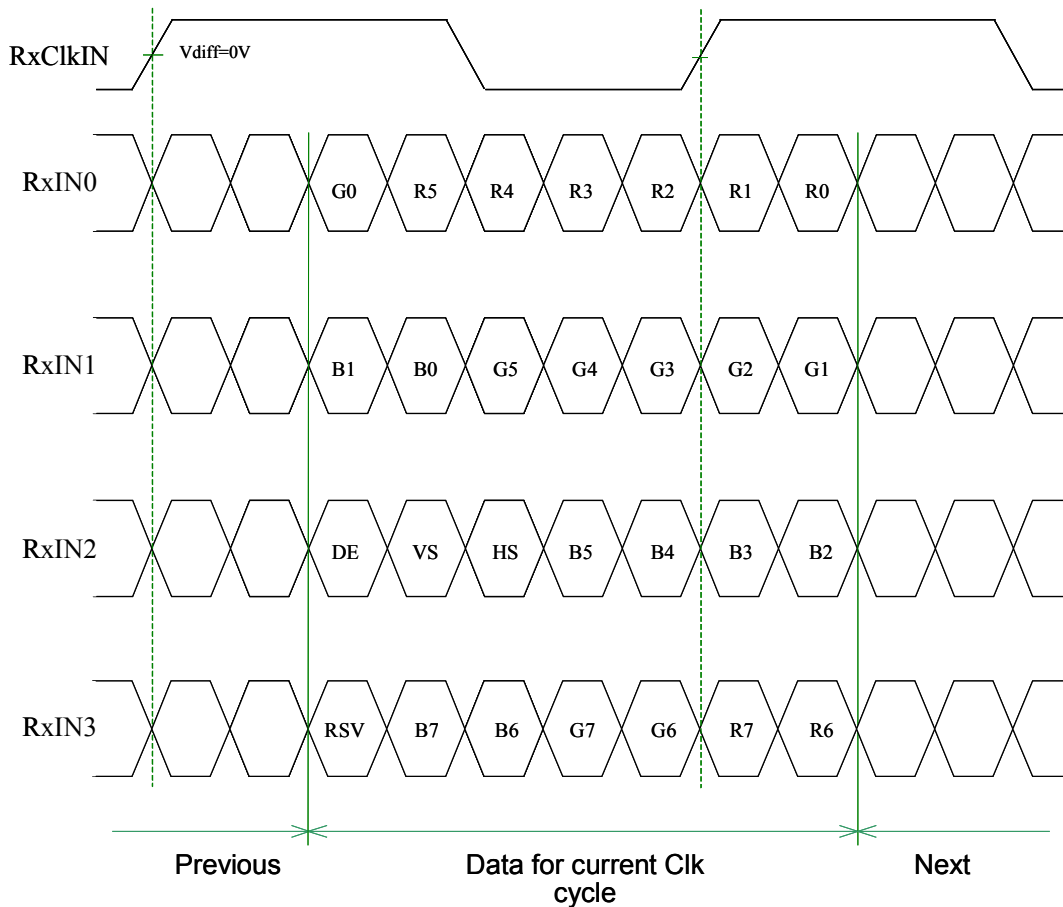

R/G/B data 7: MSB, R/G/B data 0: LSB



### 6.3 Signal Description

The module using one LVDS receiver SN75LVDS82(Texas Instruments) or compatible. LVDS is a differential signal technology for LCD interface and high speed data transfer device. Transmitter shall be SN75LVDS83(negative edge sampling) or compatible.

PIN No.	SIGNAL NAME	DESCRIPTION
1	VCC	+5.0V Power Supply
2	VCC	+5.0V Power Supply
3	VSS	Power Ground
4	VSS	Power Ground
5	RxIN0-	Negative LVDS differential data input
6	RxIN0+	Positive LVDS differential data input
7	VSS	Power Ground
8	RxIN1-	Negative LVDS differential data input
9	RxIN1+	Positive LVDS differential data input
10	VSS	Power Ground
11	RxIN2-	Negative LVDS differential data input
12	RxIN2+	Positive LVDS differential data input
13	VSS	Power Ground
14	RxCLKIN-	Negative LVDS differential clock input
15	RxCLKIN+	Positive LVDS differential clock input
16	VSS	Power Ground
17	RxIN3-	Negative LVDS differential data input
18	RxIN3+	Positive LVDS differential data input
19	VSS	Power Ground
20	NC	No Connection (For AUO Test)

**Note 1:** All GND (ground) pins should be connected together and to VSS which should also be connected to the LCD's metal frame.

**Note 2:** All VCC (power input) pins should be connected together.

**Note 3:** The drawing of connector.

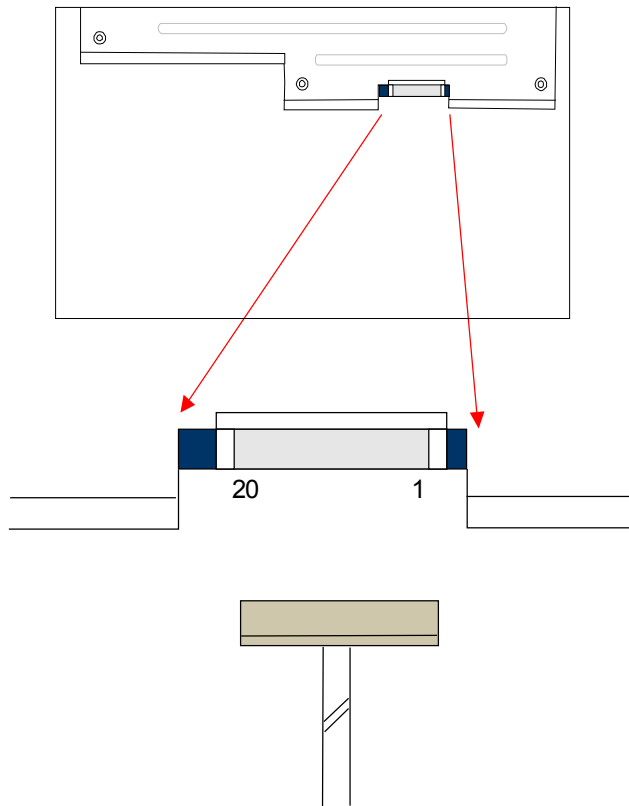

## 6.4 Interface Timings

### 6.4.1 Timing Characteristics

Item	Symbol	Min	Typ	Max	Unit	
Data CLK	Tclk	45	64	81	MHz	
H-section	Period	Th	1330	1350	1440	Tclk
	Display Area	Tdisp(h)	1280	1280	1280	Tclk
V-section	Period	Tv	777	790	860	Th
	Display Area	Tdisp(v)	768	768	768	Th
Frame Rate	F	47	60	75	Hz	

**Note:** DE mode only.

6.4.2 Timing diagram

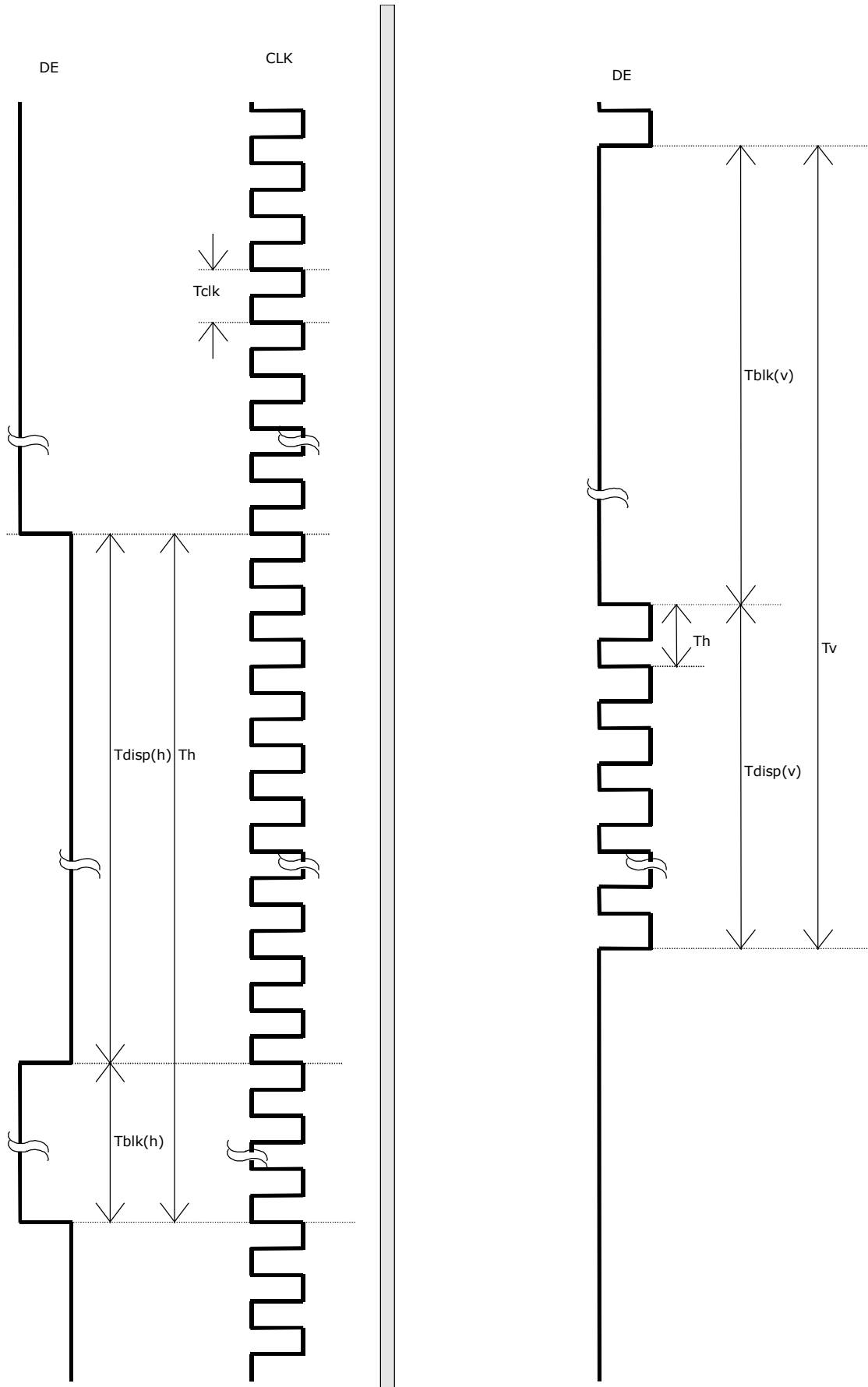

### 6.5 Power ON/OFF Sequence

Vin and lamp power on/off sequence are as follows. The timing parameters of interface signal are shown in the table below.

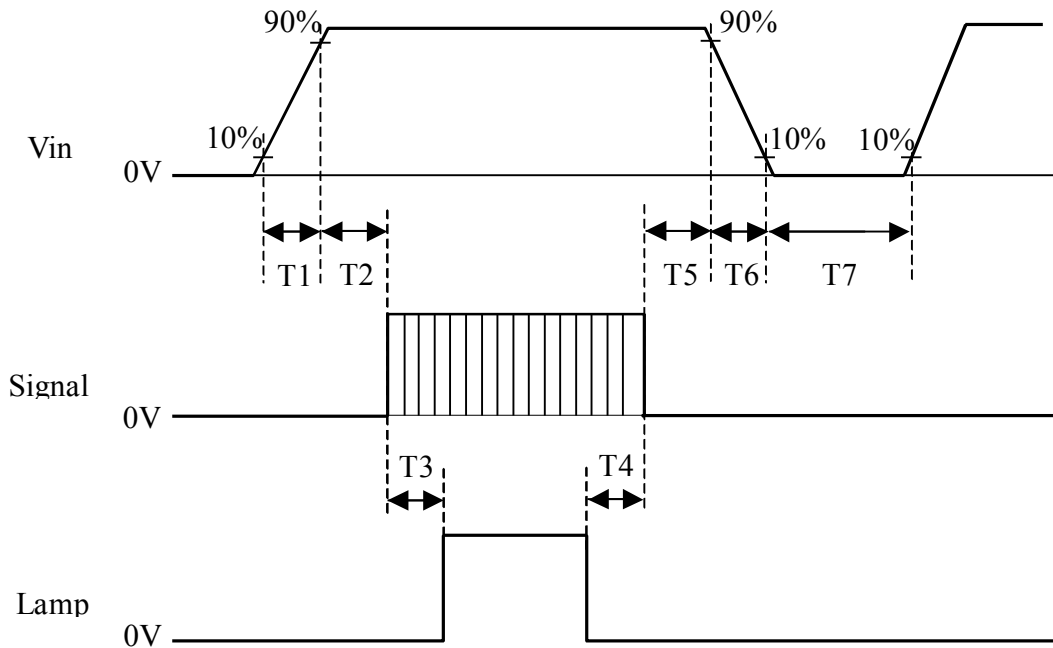

Symbol	Values			Unit
	Min.	Typ.	Max.	
T1	0.5	-	10	ms
T2	0.5	25	50	ms
T3	200	-	-	ms
T4	200	-	-	ms
T5	0.5	16	50	ms
T6	0.5	-	10	ms
T7	1000	-	-	ms

## 7.0 Connector & Pin Assignment

Physical interface is described as for the connector on module.

These connectors are capable of accommodating the following signals and will be following components.

### 7.1 TFT LCD Module

<b>Connector Name / Designation</b>	Interface Connector / Interface card
<b>Manufacturer</b>	HIROSE or compatible
<b>Type Part Number</b>	DF14H-20P-1.25H
<b>Mating Housing Part Number</b>	DF14-20S-1.25C

Pin No.	Signal Name	Pin No.	Signal Name
1	VCC, +5.0V	11	RxIN2-
2	VCC, +5.0V	12	RxIN2+
3	VSS	13	VSS
4	VSS	14	RxCLKIN-
5	RxIN0-	15	RxCLKIN+
6	RxIN0+	16	VSS
7	VSS	17	RxIN3-
8	RxIN1-	18	RxIN3+
9	RxIN1+	19	VSS
10	VSS	20	NC (FOR AUO TEST)

### 7.2 Backlight Unit

<b>Connector Name / Designation</b>	Lamp Connector / Backlight lamp
<b>Manufacturer</b>	JST
<b>Type Part Number</b>	BHSR-02VS-1
<b>Mating Type Part Number</b>	SM02B-BHSS-1-TB

	Pin No.	Input	Color	Function
<b>Upper</b>	1	Hot1	Pink	High Voltage
	2	Cold1	White	Low Voltage
	3	Hot2	Blue	High Voltage
	4	Cold2	Black	Low Voltage
<b>Lower</b>	1	Hot1	Pink	High Voltage
	2	Cold1	White	Low Voltage
	3	Hot2	Blue	High Voltage
	4	Cold2	Black	Low Voltage

## 8.0 Vibration, Shock, and Drop

### 8.1 Vibration & Shock

#### Vibration Test Spec:

- Frequency: 10 - 200Hz
- Sweep: 30 Minutes each Axis (X, Y, Z)
- Acceleration: 1.5G(10~200Hz P- P)
- Test method:

<b>Acceleration (G)</b>	1.5
<b>Frequency (Hz)</b>	10~200~10
<b>Active time (min)</b>	30

#### Shock Test Spec:

<b>Acceleration (G) -a</b>	50
<b>Active time -b</b>	20 ms
<b>Wave form</b>	Half-sin
<b>Times</b>	1

- Direction:  $\pm X$ ,  $\pm Y$ ,  $\pm Z$

### 8.2 Drop test

Package test: The drop height is 60cm.

## 9.0 Environment

The display module will meet the provision of this specification during operating condition or after storage or shipment condition specified below. Operation at 10% beyond the specified range will not cause physical damage to the unit.

### 9.1 Temperature and Humidity

#### 9.1.1 Operating Conditions

The display module operates error free, when operated under the following conditions;

Temperature	0 °C to 50 °C
Relative Humidity	8% to 95%
Wet Bulb Temperature	39.0 °C

#### 9.1.2 Shipping Conditions

The display module operates error free, after the following conditions;

Temperature	-20 °C to 60 °C
Relative Humidity	5% to 100%
Wet Bulb Temperature	39.0 °C



## 11.2 Materials

### 11.2.1 Toxicity

There will be no carcinogenic materials used anywhere in the display module. If toxic materials are used, they will be reviewed and approved by the responsible ADT Toxicologist.

### 11.2.2 Flammability

All components including electrical components that do not meet the flammability grade UL94-V1 in the module will complete the flammability rating exception approval process.

The printed circuit board will be made from material rated 94-V1 or better. The actual UL flammability rating will be printed on the printed circuit board.

## 11.3 Capacitors

If any polarized capacitors are used in the display assembly, provisions will be made to keep them from being inserted backwards.

## 12.0 Other requirement

### 12.1 National Test Lab Requirement

The display module will satisfy all requirements for compliance to

**UL 1950, First Edition**  
**CSA C22.2 No.950-M89**  
**EEC 950**  
**EN 60 950**

U.S.A. Information Technology Equipment  
 Canada, Information Technology Equipment  
 International, Information Technology Equipment  
 International, Information Processing Equipment  
 (European Norm for IEC950)

### 12.2 Label

The label is on the panel as shown below:

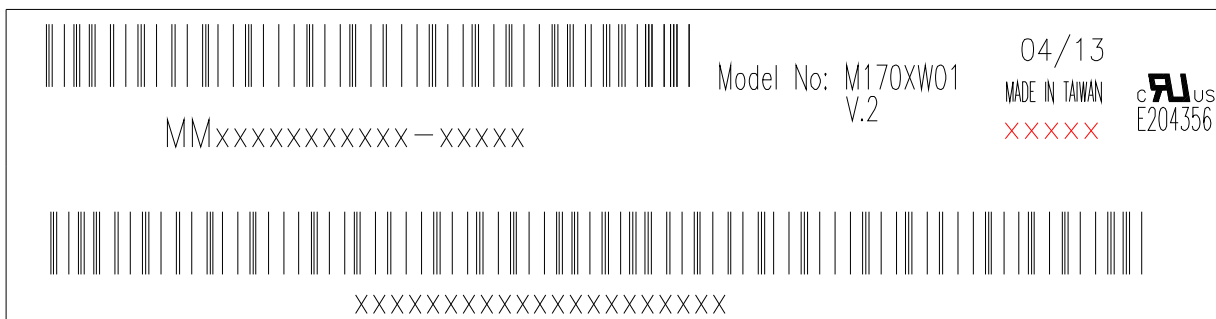



# 13.0 Mechanical Characteristics

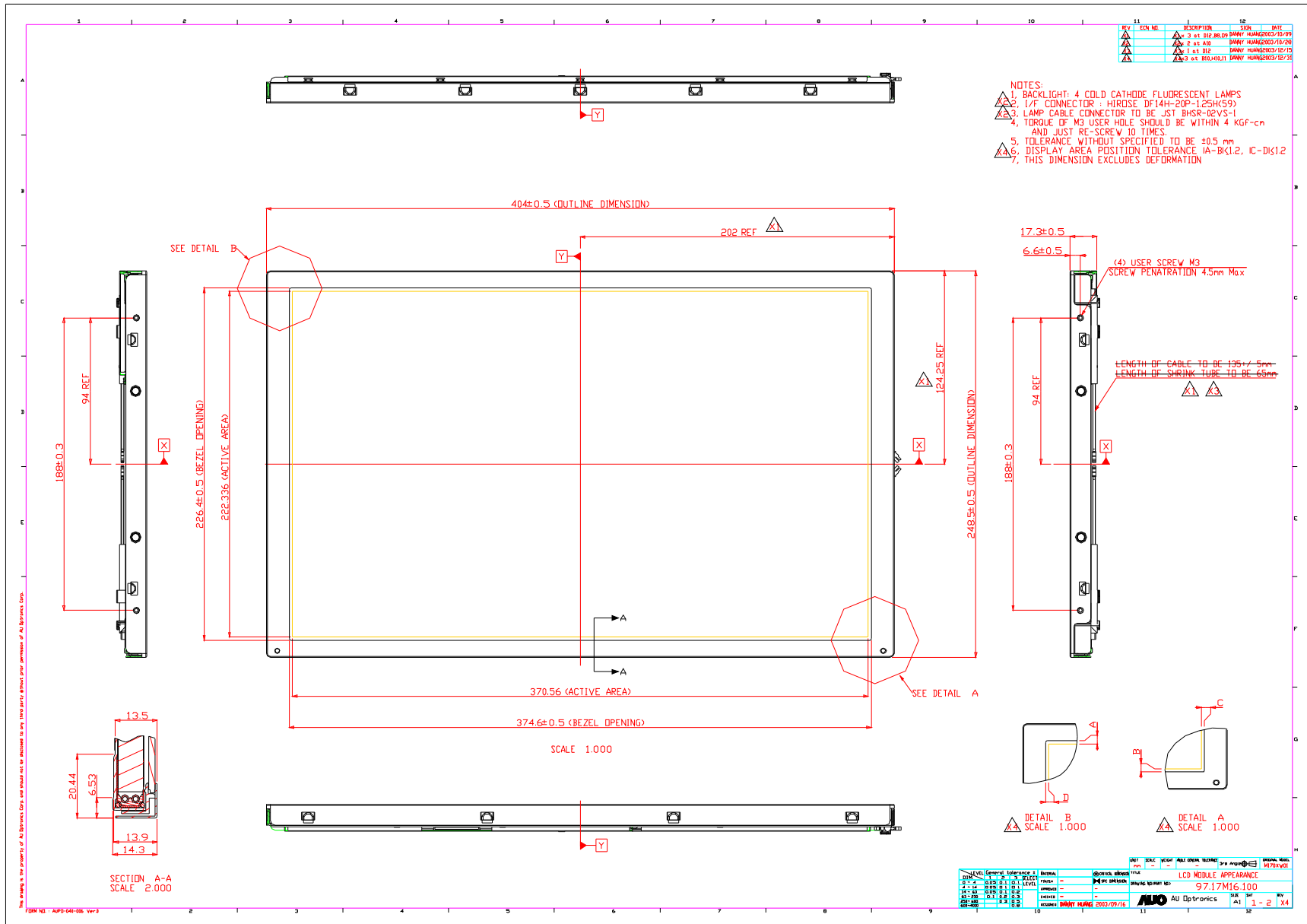

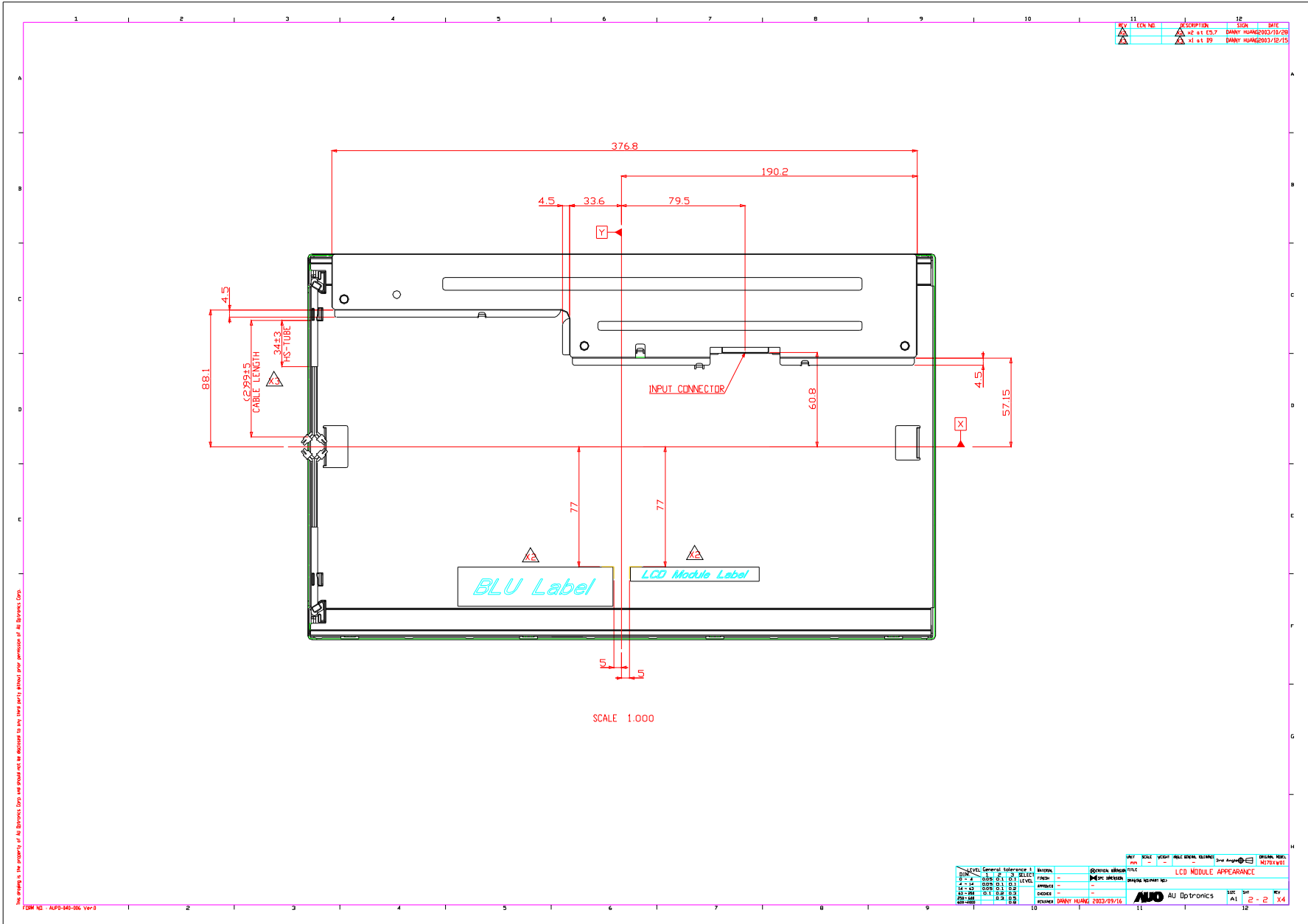

REV	CON. NO.	DESCRIPTION	SCALE	DATE
1	1	REV. 01 13.7		DANNY HUANG/2013/12/26
2	1	REV. 01 13.9		DANNY HUANG/2013/12/15

The drawing is the property of AU Optronics Corp. and should not be disclosed to any third party without prior permission of AU Optronics Corp.  
FORM NO. - APP-142-06 Ver.2

SCALE 1.000

NO.	LEVEL	DESCRIPTION	DATE	BY
1	1	General	2013/09/16	DANNY HUANG
2	2	Check		
3	3	Draw		
4	4	Check		
5	5	Check		
6	6	Check		
7	7	Check		
8	8	Check		
9	9	Check		
10	10	Check		
11	11	Check		
12	12	Check		