



Spec. No.: DDPM-EN04-0.2
Version: 2
Total pages: 29
Date: 2004-Feb-09

AU OPTRONICS CORPORATION

Product Specifications

19.0" SXGA Color TFT-LCD Module

Model Name: M190EN04 V.2

Approved by	Prepared by

AU Optronics Corporation

Customer	Checked & Approved by



Product Specifications

19.0" SXGA Color TFT-LCD Module
Model Name: M190EN04
V.2

(u) Preliminary Specifications
() Final Specifications

Note: This Specification is subject to change without notice.



i Contents

ii Record of Revision

1.0 Handling Precautions

2.0 General Description

- 2.1 Display Characteristics
- 2.2 Functional Block Diagram
- 2.3 Optical Characteristics
- 2.4 Pixel format image

3.0 Electrical characteristics

- 3.1 Absolute Maximum Ratings
- 3.2 Connectors
- 3.3 Signal Pin
- 3.4 Signal Description
- 3.5 Signal Electrical Characteristics
- 3.6 Interface Timing
 - 3.6.1 Timing Characteristics
 - 3.6.2 Timing Definition
- 3.7 Power Consumption
- 3.8 Power ON/OFF Sequence

4.0 Backlight Characteristics

- 4.1 Signal for Lamp connector
- 4.2 Parameter guideline for CCFL Inverter

5.0 Vibration, shock and drop

- 5.1 Vibration and shock
- 5.2 Drop test

6.0 Environment

- 6.1 Temperature and humidity
 - 6.1.1 Operating conditions
 - 6.1.2 Shipping conditions
- 6.2 Atmospheric pressure
- 6.3 Thermal shock

7.0 Reliability

- 7.1 Failure criteria



7.2 Failure rate

7.2.1 Usage

7.2.2 Components de-rating

7.3 CCFL life

7.4 ON/OFF cycle

8.0 Safety

8.1 Sharp edge requirement

8.2 Material

8.2.1 Toxicity

8.2.2 Flammability

8.3 Capacitors

9.0 Other requirements

9.1 Smoke free design

9.2 National test lab requirement

10.0 Mechanical Characteristics



1.0 Handling Precautions

- 1) Since front polarizer is easily damaged, please pay attention not to scratch it.
- 2) Please be sure power supply is off, when inserting or disconnecting from input connector.
- 3) Wipe off water drop immediately. Long contact with water may cause discoloration or spots.
- 4) When the panel surface is soiled, wipe it with absorbent cotton or other soft cloth.
- 5) Since the panel is made of glass, it may break or crack if dropped or bumped on hard surface.
- 6) Since CMOS LSI is used in this module, take care of static electricity and insure human earth when handling.
- 7) Do not open nor modify the Module Assembly.
- 8) Do not press the reflector sheet at the back of the module to any directions.
- 9) At the insertion or removal of the Signal Interface Connector, be sure not to rotate nor tilt the Interface Connector of the TFT-LCD module.
- 10) After installation of the TFT-LCD module into an enclosure (LCD monitor housing, for example), do not twist nor bend the TFT -LCD module even momentary. At designing the enclosure, it should be taken into consideration that no bending/twisting forces are applied to the TFT -LCD module from outside. Otherwise the TFT -LCD module may be damaged.



2.0 General Description

This specification applies to the 19.0 inch Color TFT-LCD Module M190EN04. The display supports the SXGA (1280 x 1024) screen format and 16.2M colors (RGB 6-bits). All input signals are 2 Channel LVDS interface compatible. This module does not contain an inverter card for backlight.

2.1 Display Characteristics

The following items are characteristics summary on the table under 25 °C condition:

ITEMS	Unit	SPECIFICATIONS
Screen Diagonal	[mm]	480 (19.0")
Active Area	[mm]	376.32 (H) x 301.056 (V)
Pixels H x V		1280(x3) x 1024
Pixel Pitch	[mm]	0.294 (per one triad) x 0.294
Pixel Arrangement		R.G.B. Vertical Stripe
Display Mode		Normally White
White Luminance	[cd/m ²]	250 (center, Typ) @7mA
Contrast Ratio		450 : 1 (Typ)
Optical Response Time	[msec]	16 ms(Typ)
Color Saturation		72% NTSC
Nominal Input Voltage VDD	[Volt]	+5.0 V
Power Consumption (VDD line + CCFL line)	[Watt]	28W(Typ) (w/o Inverter, All black pattern)
Weight	[Grams]	2700 (TBD)
Physical Size	[mm]	396 (H) x 324 (V) x 18 (D) (Typ)
Electrical Interface		R/G/B data, Clock
Support Color		262k colors (RGB 6-bit data)
Surface Treatment		Anti-Glare, Hard Coating, 3H
Temperature Range		
Operating	[°C]	0 to +50
Storage (Shipping)	[°C]	-20 to +60
TCO compliance		Meet TCO'03 regulation



2.2 Functional Block Diagram

The following diagram shows the functional block of the 19.0 inches Wide Color TFT-LCD Module:

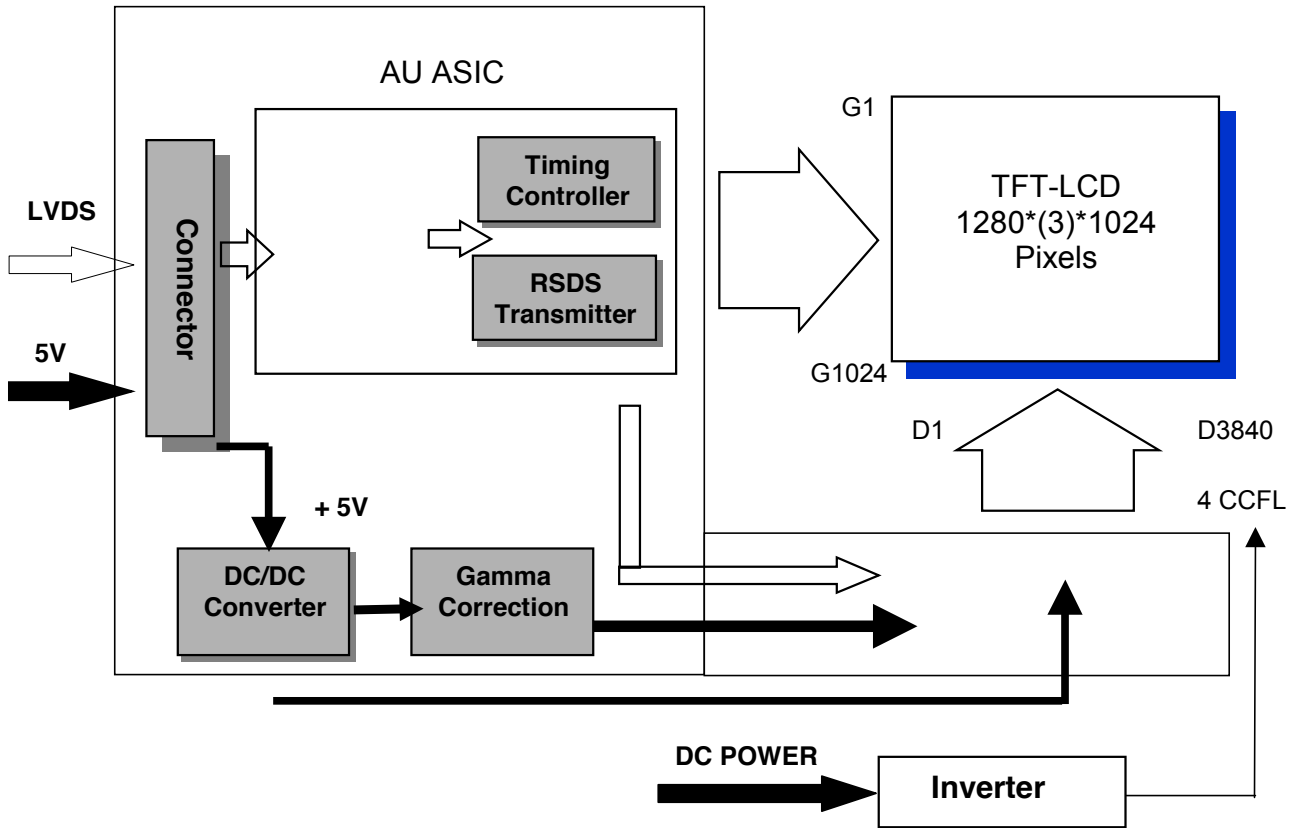

JAE FI-X30SSL-HF

Mating Type: FI-X30HL

JST-BHSR-02VS-1

SM02 (8.0) B-BHSS



2.3 Optical Characteristics

The optical characteristics are measured under stable conditions at 25°C (Room Temperature):

Item	Unit	Conditions	Min.	Typ.	Max.
Viewing Angle	[degree]	Horizontal (Right) CR = 10 (Left)	-	65 65	-
		Vertical (Up) CR = 10 (Down)	-	65 65	-
Contrast ratio		Normal Direction	-	450	-
Response Time (Note 1)	[msec]	Raising Time	-	4	5
		Falling Time	-	12	20
		Rising + Falling	-	16	25
Color / Chromaticity Coordinates (CIE)		Red x	-	0.644	-
		Red y	-	0.348	-
		Green x	-	0.293	-
		Green y	-	0.628	-
		Blue x	-	0.141	-
		Blue y	-	0.08	-
Color Coordinates (CIE) White		White x	-	0.31	-
		White y	-	0.33	-
White Luminance @ CCFL 7mA (Center)	[cd/m ²]		200	250	-
Luminance Uniformity (Note 2)	[%]		75	80	-
Cross talk (in 75Hz) (Note 3)	[%]		-	-	1.5

Equipment Pattern Generator, Power Supply, Digital Voltmeter, Luminance meter
(PR 880, BM-5A/ BM7)

Aperture 1° with 100cm VD or 2° with 50cm viewing distance

Test Point Center (VESA point 9)

Environment < 1 lux

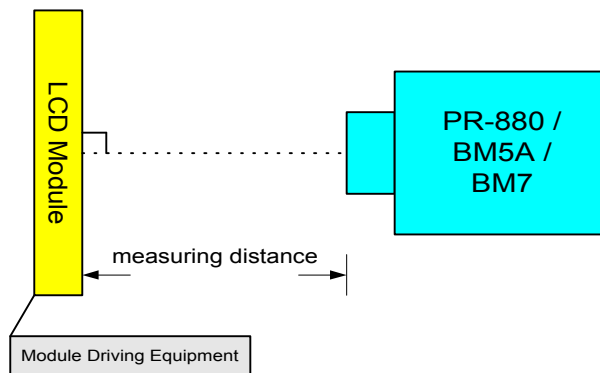



Note 1: Definition of Response time

The output signals of photo detector are measured when the input signals are changed from “Black” to “White ” (raising time), and from “White” to “Black” (falling time), respectively. The response time is interval between the 10% and 90% of amplitudes.

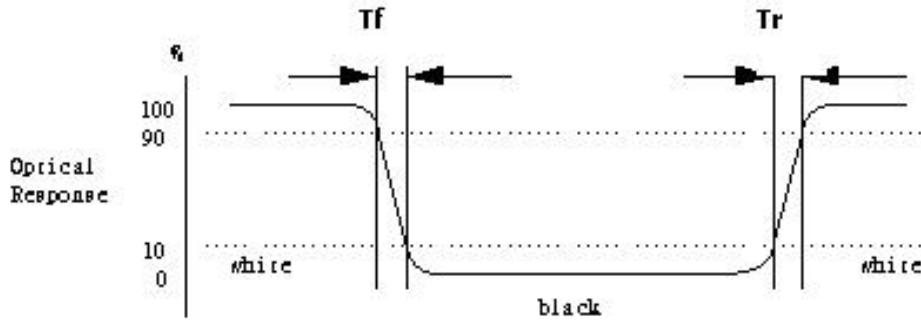

Note 2: Brightness uniformity of these 9 points is defined as below

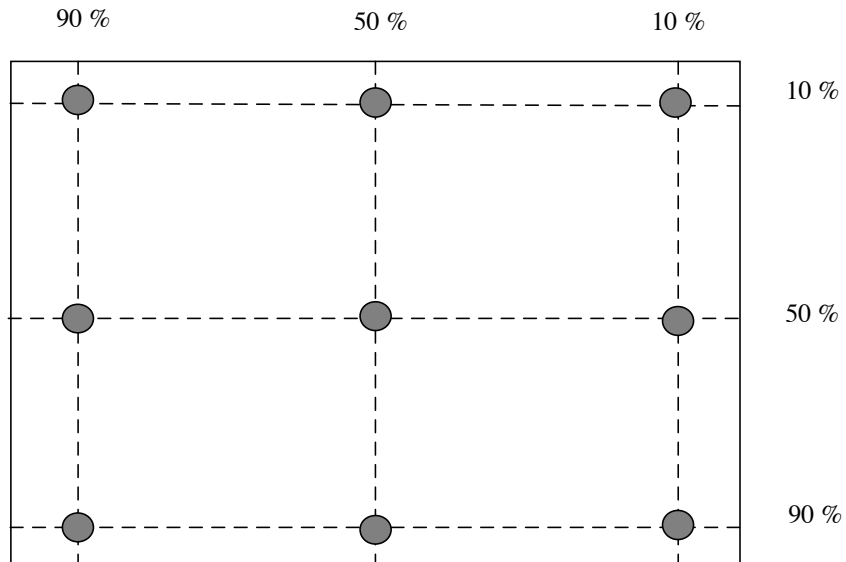

Minimum Luminance in 9 Points (1-9)

$$\text{Uniformity} = \frac{\text{Minimum Luminance in 9 Points (1-9)}}{\text{Maximum Luminance in 9 Points (1-9)}}$$

Maximum Luminance in 9 Points (1-9)



Note 3:

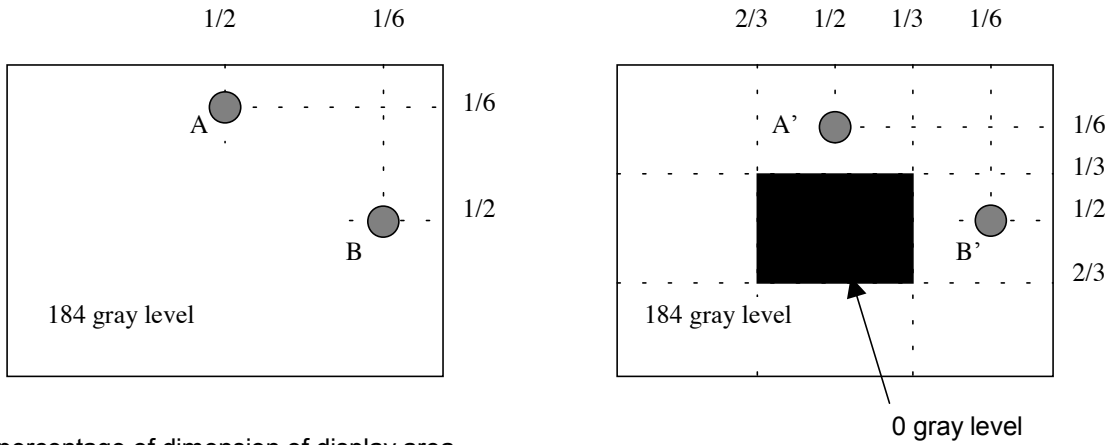

Unit: percentage of dimension of display area

$|L_A - L_{A'}| / L_A \times 100\% = 1.5\% \text{ max.}$, L_A and L_B are brightness at location A and B

$|L_B - L_{B'}| / L_B \times 100\% = 1.5\% \text{ max.}$, $L_{A'}$ and $L_{B'}$ are brightness at location A' and B'

2.4. Pixel format image

Following figure shows the relationship of the input signals and LCD pixel format.

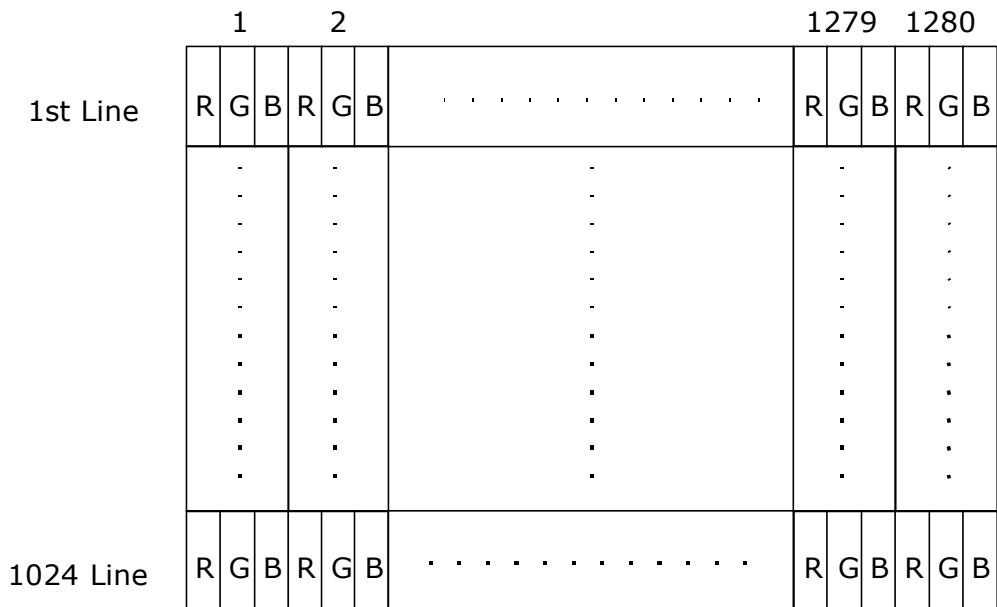



3.0 Electrical characteristics

3.1 Absolute Maximum Ratings

Absolute maximum ratings of the module is as following:

Item	Symbol	Min	Max	Unit	Conditions
Logic/LCD Drive Voltage	VIN	-0.3	+5.5	[Volt]	
Select LVDS data order	SELLVDS	NC	NC	[Volt]	
CCFL Inrush current	ICFLL	-	38	[mA]	Note 1
CCFL Current	ICFL	-	7.6	[mA] rms	
Operating Temperature	TOP	0	+50	[°C]	Note 2
Operating Humidity	HOP	8	95	[%RH]	Note 2
Storage Temperature	TST	-20	+60	[°C]	Note 2
Storage Humidity	HST	8	95	[%RH]	Note 2

Note 1: Duration=50 msec.

Note 2: Maximum Wet-Bulb should be 39°C and No condensation.

Relative Humidity %

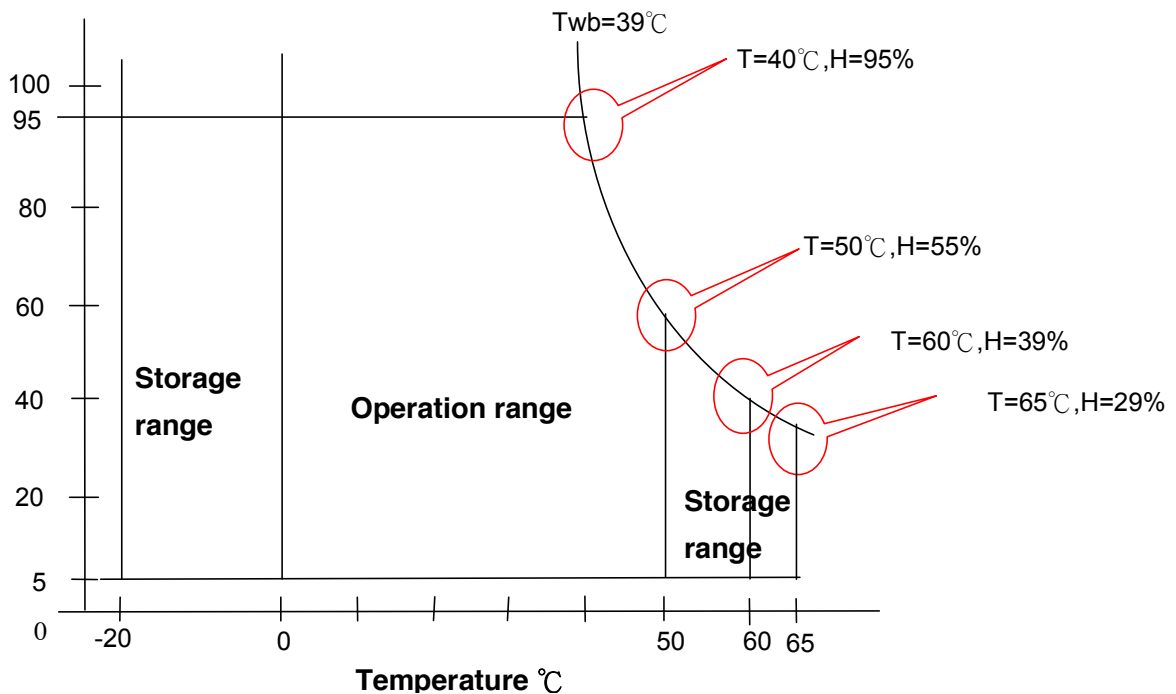



3.2 Connectors

Physical interface is described as for the connector on module. These connectors are capable of accommodating the following signals and will be following components.

Connector Name / Designation	Interface Connector / Interface card
Manufacturer	JAE or compatible
Type Part Number	FI-X30SSL-HF
Mating Housing Part Number	FI-X30HL
Connector Name / Designation	Lamp Connector / Backlight lamp
Manufacturer	JST
Type Part Number	BHSR-02VS-1
Mating Type Part Number	SM02 (8.0) B-BHSS

3.3 Signal Pin

Pin#	Signal Name	Pin#	Signal Name
1	RxO0-	2	RxO0+
3	RxO1-	4	RxO1+
5	RxO2-	6	RxO2+
7	GND	8	RxOC-
9	RxOC+	10	RxO3-
11	RxO3+	12	RxE0-
13	RxE0+	14	GND
15	RxE1-	16	RxE1+
17	GND	18	RxE2-
19	RxE2+	20	RxEC-
21	RxEC+	22	RxE3-
23	RxE3+	24	GND
25	NC	26	NC
27	NC	28	Power
29	Power	30	Power



3.4 Signal Description

PIN #	SIGNAL NAME	DESCRIPTION
1	RxO0-	Negative LVDS differential data input (Odd data)
2	RxO0+	Positive LVDS differential data input (Odd data)
3	RxO1-	Negative LVDS differential data input (Odd data)
4	RxO1+	Positive LVDS differential data input (Odd data)
5	RxO2-	Negative LVDS differential data input (Odd data, H-Sync,V-Sync,DSPTMG)
6	RxO2+	Positive LVDS differential data input (Odd data, H-Sync,V-Sync,DSPTMG)
7	GND	Power Ground
8	RxOC-	Negative LVDS differential clock input (Odd clock)
9	RxOC+	Positive LVDS differential clock input (Odd clock)
10	RxO3-	Negative LVDS differential data input (Odd data)
11	RxO3+	Positive LVDS differential data input (Odd data)
12	RxE0-	Negative LVDS differential data input (Even clock)
13	RxE0+	Positive LVDS differential data input (Even data)
14	GND	Power Ground
15	RxE1-	Positive LVDS differential data input (Even data)
16	RxE1+	Negative LVDS differential data input (Even data)
17	GND	Power Ground
18	RxE2-	Negative LVDS differential data input (Even data)
19	RxE2+	Positive LVDS differential data input (Even data)
20	RxEC-	Negative LVDS differential clock input (Even clock)
21	RxEC+	Positive LVDS differential clock input (Even clock)
22	RxE3-	Negative LVDS differential data input (Even data)
23	RxE3+	Positive LVDS differential data input (Even data)
24	GND	Power Ground
25	NC	-
26	NC	-
27	NC	-
28	POWER	Power
29	POWER	Power
30	POWER	Power

Note: Input signals of odd and even clock shall be the same timing.

LVDS DATA Name	Description
DSP	Display Timing: (DE mode) When the signal is high, the pixel data shall be valid to be displayed
V-S	Vertical Sync: Both Positive and Negative polarity are acceptable
H-S	Horizontal Sync: Both Positive and Negative polarity are acceptable



TI LVDS transmitter SN75LVDS83	Module LVDS signal (interface connector pin7)
Signal Name	Low(open)
D0	Red0
D1	Red1
D2	Red2
D3	Red3
D4	Red4
D5	Red7
D6	Red5
D7	Green0
D8	Green1
D9	Green2
D10	Green6
D11	Green7
D12	Green3
D13	Green4
D14	Green5
D15	Blue0
D16	Blue6
D17	Blue7
D18	Blue1
D19	Blue2
D20	Blue3
D21	Blue4
D22	Blue5
D23	NA
D24	H Sync
D25	V Sync
D26	Display Timing
D27	Red6



8bits input: M190EN04 V2 only catch bit 2 to bit 7 for 6 bit display
6bits input data format marked with ().

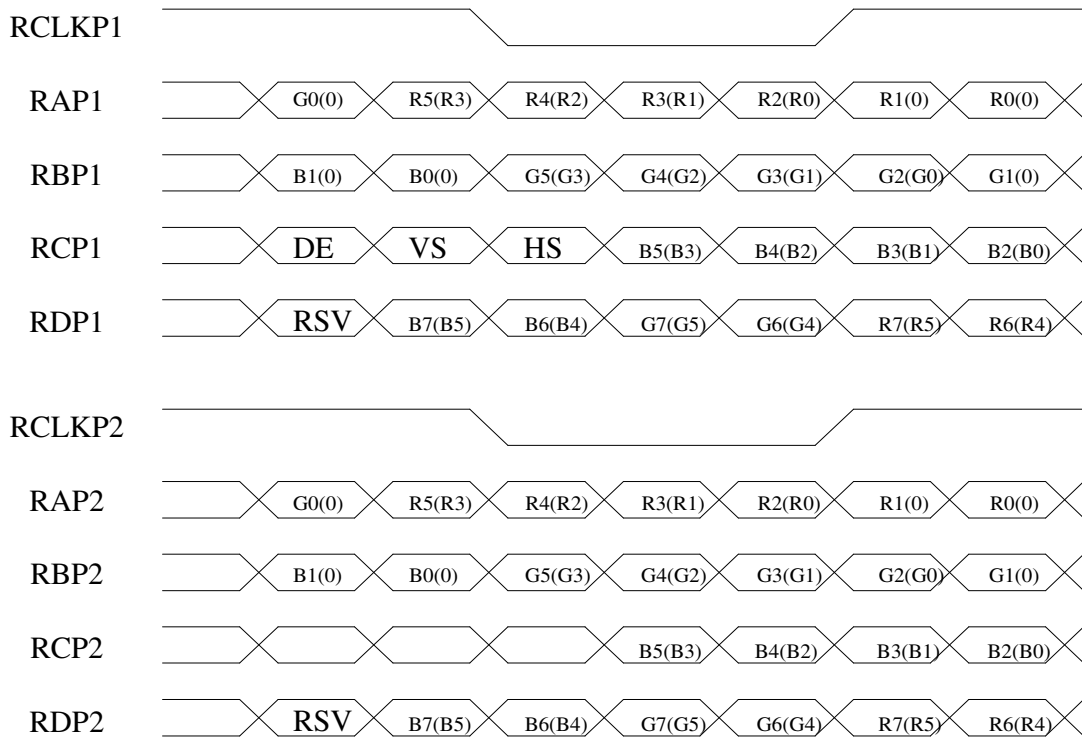

Note: R/G/B data 7:MSB, R/G/B data 0:LSB

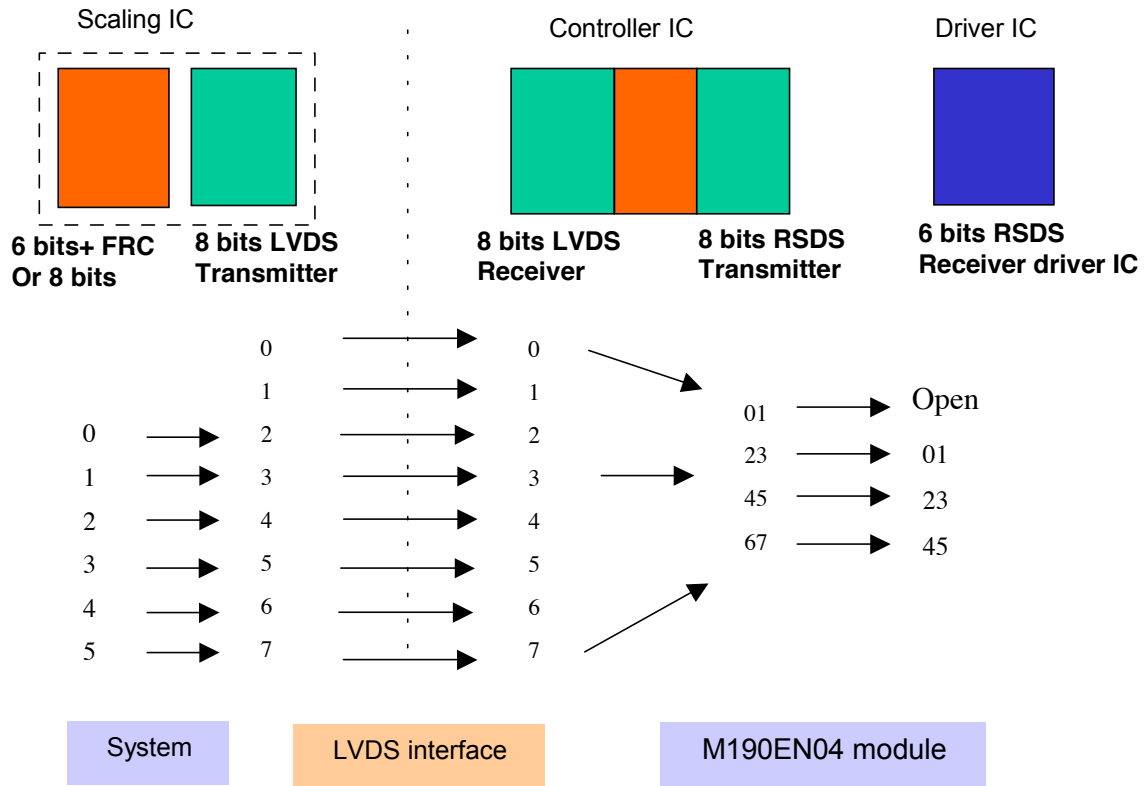

3.5 Signal Electrical Characteristics

Input signals shall be low or Hi-Z state when Vin is off
 It is recommended to refer the specifications of SN75LVDS82DGG (Texas Instruments) in detail.

Each signal characteristics are as follows;

Parameter	Condition	Min	Max	Unit
Vth	Differential Input High Voltage(Vcm=+1.2V)		100	[mV]
Vtl	Differential Input Low Voltage(Vcm=+1.2V)	-100		[mV]

Note: The value of Vcm from LVDS transmitter should follow the following guide.

Parameter	Min	Typ.	Max	Unit
Vcm	+1.0	+1.2	+1.35	[V]



3.6 Interface Timings

3.6.1 Timing Characteristics

Signal	Item	Symbol	MIN	TYP	MAX	Unit
DTCLK	Freq.	Fdck	50	67.5	70	MHz
DTCLK	Cycle	Tck	14.2	14.8	20	ns
+V-Sync	Frame Rate	1/Tv	56.25	75	77	Hz
+V-Sync	Cycle	Tv	13	13.33	17.78	ms
+V-Sync	Cycle	Tv	1035	1066	2047	lines
+V-Sync	Active level	Tva	3	3		lines
+V-Sync	V-back porch	Tvb	7	38	63	lines
+V-Sync	V-front porch	Tvf	1	1		lines
+DSPTMG	V-Line	m	-	1024	-	lines
+H-Sync	Scan rate	1/Th	-	80.06	-	KHz
+H-Sync	Cycle	Th	800	844	1023	Tck
+H-Sync	Active level	Tha (*1)	4	56		Tck
+H-Sync	Back porch	Thb (*1)	4	124		Tck
+H-Sync	Front porch	Thf	4	24		Tck
+DSPTMG	Display Pixels	n	-	640	-	Tck

Note: Typical value refer to VESA STANDARD



3.6.2 Timing Definition

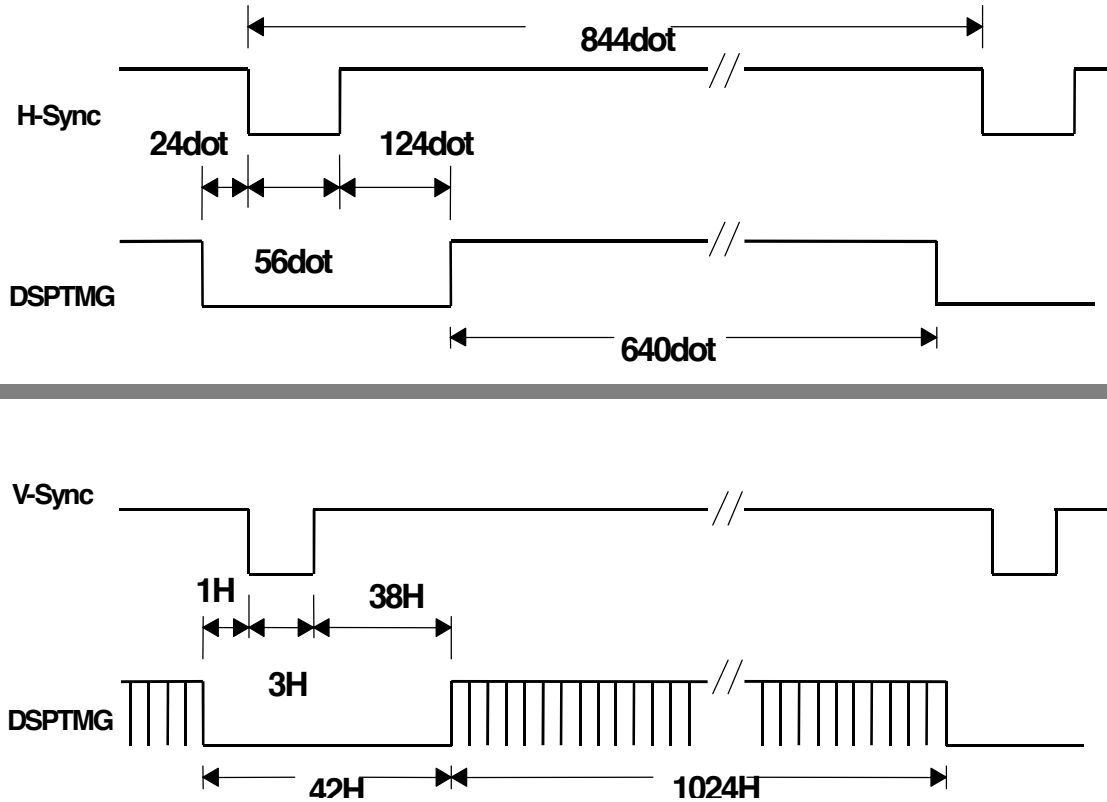

3.7 Power Consumption

Symbol	Parameter	Min	Typ	Max	Units	Condition
VDD	Logic/LCD Drive Voltage	4.5	5	5.5	[Volt]	
IDD	VDD current		1000	1400	[mA]	Vin=5V, All Black Pattern
PDD	VDD Power		4.8	7.5	[Watt]	Vin=5V, All Black Pattern
VDDrp	Allowable Logic/LCD Drive Ripple Voltage			100	[mV] p-p	
VDDns	Allowable Logic/LCD Drive Ripple Noise			100	[mV] p-p	



3.8 Power ON/OFF Sequence

Vin power and lamp on/off sequence is as follows. Interface signals are also shown in the chart. Signals from any system shall be Hi-Z state or low level when Vin is off.

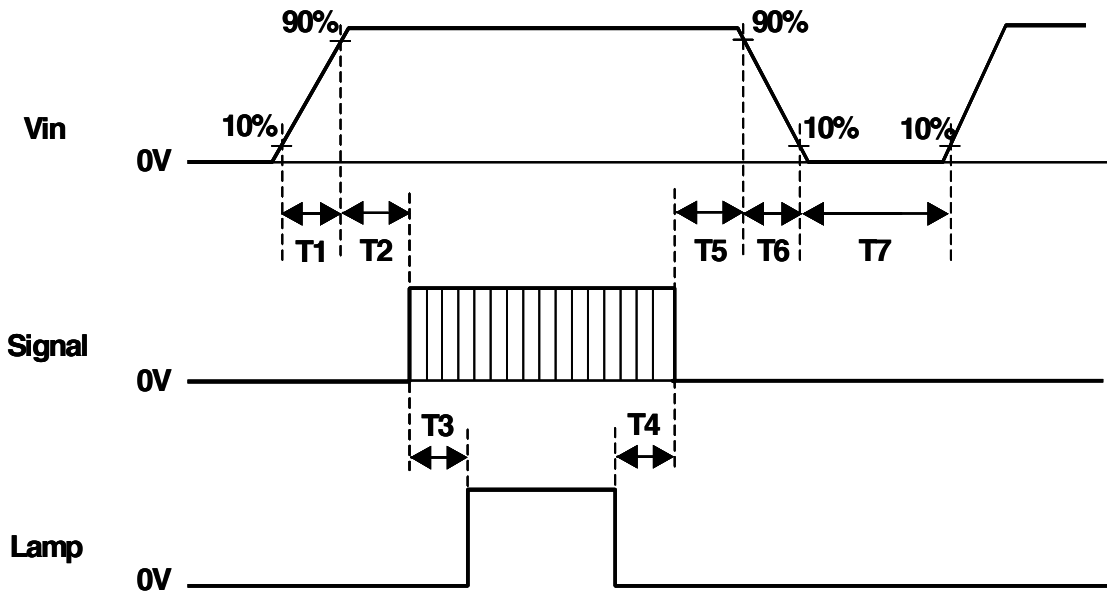

Symbol	Values			Unit
	Min	Typ	Max	
T1	0.5	-	10	[ms]
T2	0.5	40	50	[ms]
T3	200	-	-	[ms]
T4	200	-	-	[ms]
T5	0.5	16	50	[ms]
T6	0.5	-	10	[ms]
T7	1000	-	-	[ms]



4.0 Backlight Characteristics

4.1 Signal for Lamp connector

Pin #	Signal Name
1	Lamp High Voltage
2	Lamp Low Voltage



4.2 Parameter guideline for CFL Inverter

Symbol	Parameter	Min	Typ	Max	Units	Condition
(L63)	White Luminance	200	250	-	[cd/m ²]	(Ta=25°C)
ISCFL	CCFL standard current	6.5	7.0	7.5	[mA] rms	(Ta=25°C)
IRCFL	CCFL operation range	3.0	7.0	7.5	[mA] rms	(Ta=25°C)
ICFL	CCFL Inrush current	-	26	34	[mA]	Note 1
fCFL	CCFL Frequency	40	50	80	[KHz]	(Ta=25°C) Note 2
ViCFL (0°C)	CCFL Ignition Voltage	1800			[Volt] rms	(Ta=0°C) Note 3
ViCF (25°C)	CCFL Ignition Voltage	1500			[Volt] rms	(Ta=25°C) Note 3
TCFL	CCFL Dark start time			1.0	sec	(Ta=25°C)
VCFL	CCFL Discharge Voltage (Reference)		700	860	[Volt] rms	(Ta=25°C) Note 4
PCFL	CCFL Power consumption		19.6	25.8	[Watt]	(Ta=25°C) Note 4

Note 1: Duration=50 [msec]

Note 2: CCFL Frequency should be carefully determined to avoid interference between inverter and TFT LCD

Note 3: CCFL inverter should be able to give out a power that has a generating capacity of over 1800 voltage. Lamp units need 1800 voltage minimum for ignition

Note 4: Calculator value for reference (ISCFL x VCFL x 4=PCFL)

Note 5: Lamp connecting method is required to use "Terminal connecting".



5.0 Vibrations, Shock, and Drop

5.1 Vibration & Shock

Frequency: 10 - 200Hz

Sweep: 30 Minutes each Axis (X, Y, Z)

Acceleration: 1.5G (10~200Hz P- P)

Test method:

Acceleration (G)	1.5
Frequency (Hz)	10~200~10
Active time (min)	30

5.2 Shock Test Spec:

Acceleration (G)	50
Active time	20
Wave form	half-sin
Times	1

Direction: $\pm X$, $\pm Y$, $\pm Z$

5.3 Drop test

Package test: The drop height is 60 cm.



6.0 Environment

The display module will meet the provision of this specification during operating condition or after storage or shipment condition specified below. Operation at 10% beyond the specified range will not cause physical damage to the unit.

6.1 Temperature and Humidity

6.1.1 Operating Conditions

The display module operates error free, when operated under the following conditions;

Temperature	0 °C to 50 °C
Relative Humidity	8% to 95%
Wet Bulb Temperature	39.0 °C

6.1.2 Shipping Conditions

The display module operates error free, after the following conditions;

Temperature	-20 °C to 60 °C
Relative Humidity	8% to 95%
Wet Bulb Temperature	39.0 °C

6.2 Atmospheric Pressure

The display assembly is capable of being operated without affecting its operations over the pressure range as following specified;

	Pressure	Note
Maximum Pressure	1040hPa	0m = sea level
Minimum Pressure	674hPa	3048m = 10.000 feet

Note: Non-operation attitude limit of this display module = 30,000 feet. = 9145 m.

6.3 Thermal Shock

The display module will not sustain damage after being subjected to 100 cycles of rapid temperature change. A cycle of rapid temperature change consists of varying the temperature from -20°C to 60°C, and back again.



Definition of life: Brightness becomes 50% or less than the minimum luminance value of CCFL.

7.4 ON/OFF Cycle

The display module will be capable of being operated over the following ON/OFF Cycles.

ON/OFF	Value	Cycles
+Vin and CCFL power	30,000	10 seconds on / 10 seconds off

8.0 Safety

8.1 Sharp Edge Requirements

There will be no sharp edges or comers on the display assembly that could cause injury.

8.2 Materials

8.2.1 Toxicity

There will be no carcinogenic materials used anywhere in the display module. If toxic materials are used, they will be reviewed and approved by the responsible AU Toxicologist.

8.2.2 Flammability

All components including electrical components that do not meet the flammability grade UL94-V1 in the module will complete the flammability rating exception approval process. The printed circuit board will be made from material rated 94-V1 or better. The actual UL flammability rating will be printed on the printed circuit board.

8.3 Capacitors

If any polarized capacitors are used in the display assembly, provisions will be made to keep them from being inserted backwards.

9.0 Other requirements

9.1 National Test Lab Requirement

The display module will satisfy all requirements for compliance to



UL 1950, First Edition
CSA C22.2 No.950-M89
EEC 950
EN 60 950

U.S.A. Information Technology Equipment
Canada, Information Technology Equipment
International, Information Technology Equipment
International, Information Processing Equipment
(European Norm for IEC950)

9.2 Label

9.2.1 Product label

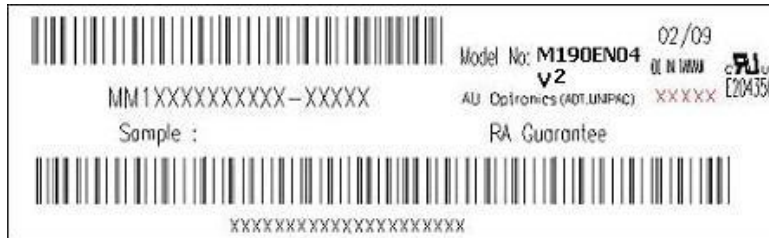

10.0 Mechanical Characteristics

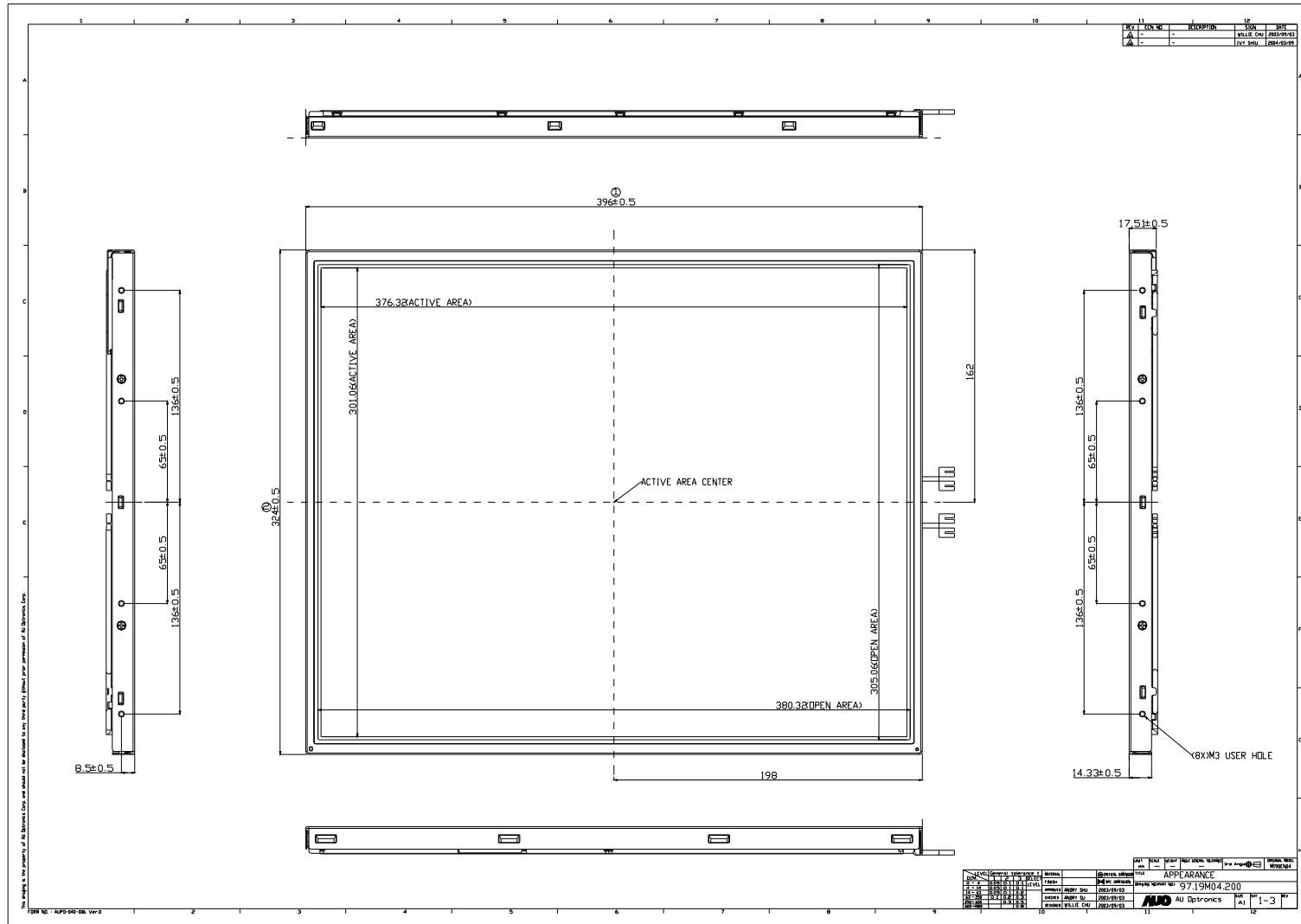

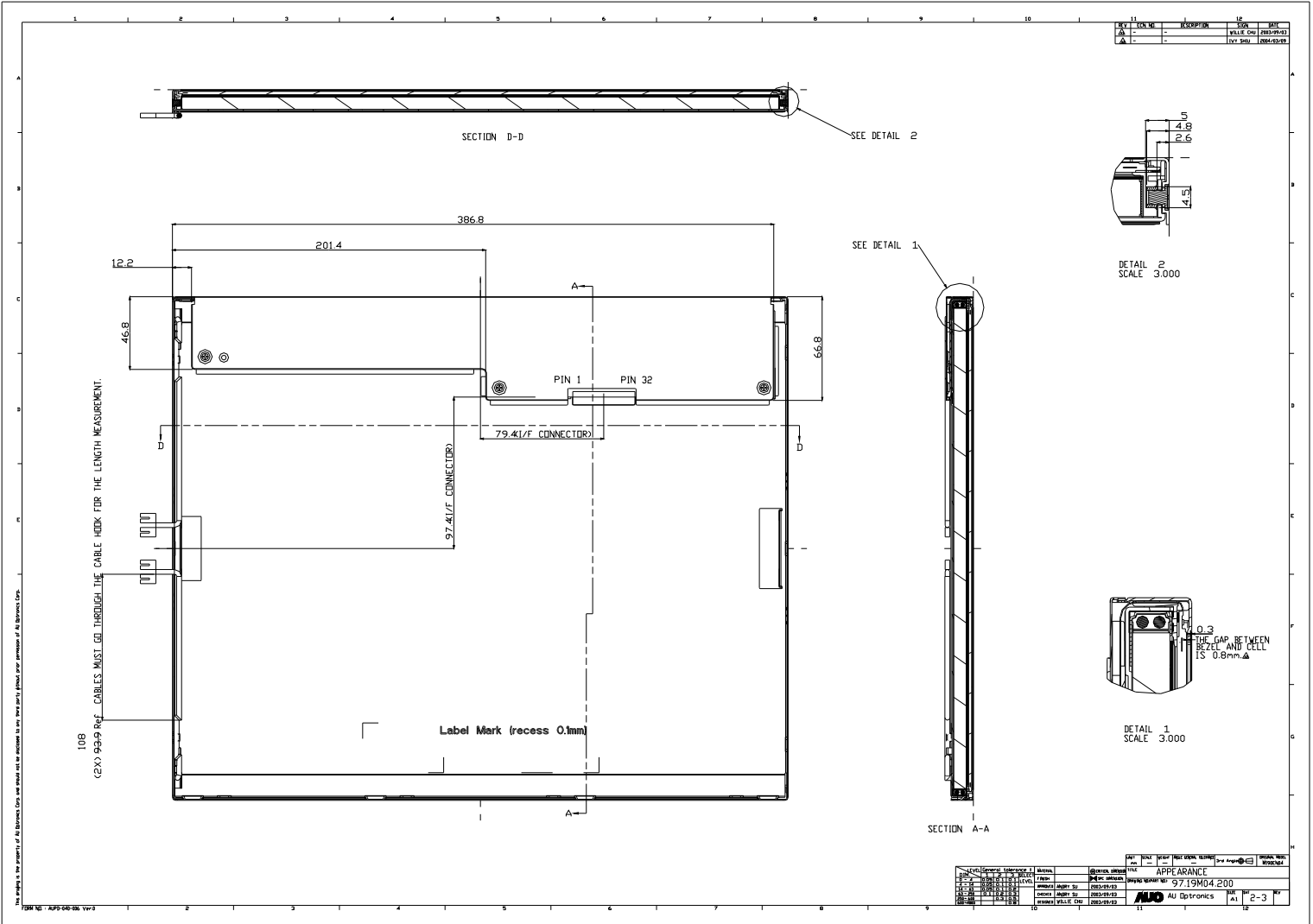

SCALE	NO.	DESCRIPTION	DATE	BY
A	-	INITIAL CD	2003-07-03	
A	-	REV. 001	2003-07-03	

NO.	REV.	DATE	DESCRIPTION	BY	CHK.	APP.
1	1	2003-07-03	INITIAL CD			
2	1	2003-07-03	REV. 001			

NO.	REV.	DATE	DESCRIPTION	BY	CHK.	APP.
1	1	2003-07-03	INITIAL CD			
2	1	2003-07-03	REV. 001			

NO.	REV.	DATE	DESCRIPTION	BY	CHK.	APP.
1	1	2003-07-03	INITIAL CD			
2	1	2003-07-03	REV. 001			

NO.	REV.	DATE	DESCRIPTION	BY	CHK.	APP.
1	1	2003-07-03	INITIAL CD			
2	1	2003-07-03	REV. 001			

REV	DESCRIPTION	DATE	BY
1	INITIAL		
2	REVISION		

- NOTE:
- 1.PRELIMINARY DRAWING FOR REFERENCE ONLY.
 - 2.THE DIMENSION EXCLUDES DEFORMATION.
 - 3.MODULE THICKNESS SHOULD BE 18mm MAX.
 - 4.TOLERANCE WITHOUT NOTICED TO BE ±0.5mm.
 - 5.LAMP CABLE CONNECTOR TO BE JST BHSR-02VS-1
 - 6.I/F CONNECTOR TO BE JAE FI-X30SSL-HF.
 - 7.M3 USER HOLE SCREW TORQUE 4.0kg-cm MAX.
 - 8.USER HOLE SCREW PENETRATION 4.5mm MAX.
 - 9.DIMENSION TOLERANCE A-B $1.0 \leq$, C-D $1.0 \leq$

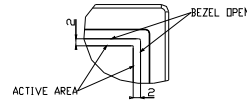

DETAIL A
SCALE 2.000

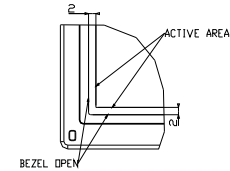

DETAIL B
SCALE 2.000

CHECK NOTE 9

THICKNESS 18.0mm MAX IN THIS AREA

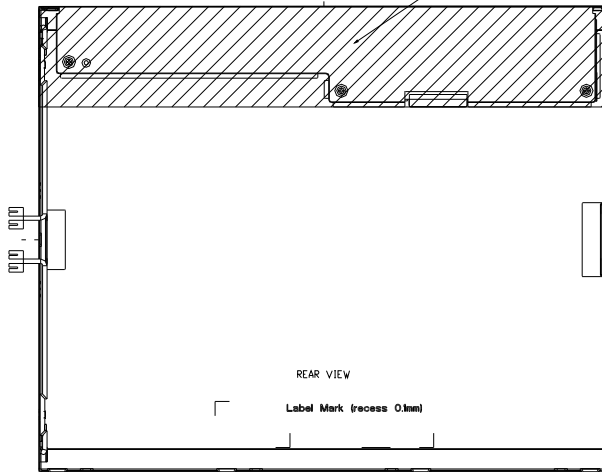

SCALE 0.800

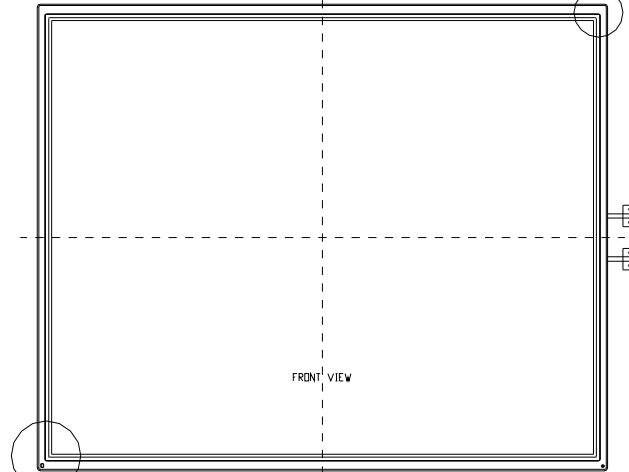

SCALE 0.800

All rights reserved. All dimensions are subject to change without notice. All dimensions are in millimeters unless otherwise specified.

NO.	DESCRIPTION	DATE	BY	CHK	APP
1	INITIAL				
2	REVISION				

APPEARANCE

9719MG4.200

3-3