

# AU OPTRONICS CORPORATION

## Product Specifications

20.1" UXGA Color TFT-LCD Module

Model Name: M201UN02 V.5

Approved by	Prepared by
<i>CC Chiu</i>	<i>Alec Peng</i>

*DDBU Marketing Division / AU Optronics Corporation*

Customer	Checked & Approved by



Support: Displays & Embedded Computing:  
Tel. 06126-590-337  
Tel. 06126-590-290  
Tel. 06126-590-260  
Fax 06126-590-138  
display@glyn.de  
www.glyn.de  
www.glyn.com

## Product Specification

### 20.1" UXGA Color TFT-LCD Module Model Name: M201UN02 V.5

Preliminary Specifications  
 Final Specifications

**Note: This Specification is subject to change without notice.**

**i Contents****ii Record of Revision****1.0 Handling Precautions****2.0 General Description**

- 2.1 Display Characteristics
- 2.2 Functional Block Diagram
- 2.3 Optical Characteristics
- 2.4 Pixel format image

**3.0 Electrical characteristics**

- 3.1 Absolute Maximum Ratings
- 3.2 Connectors
- 3.3 Signal Pin
- 3.4 Signal Description
- 3.5 Signal Electrical Characteristics
- 3.6 Interface Timing
  - 3.6.1 Timing Characteristics
  - 3.6.2 Timing Definition
- 3.7 Power Consumption
- 3.8 Power ON/OFF Sequence

**4.0 Backlight Characteristics**

- 4.1 Signal for Lamp connector
- 4.2 Parameter guide line for CCFL Inverter

**5.0 Vibration, shock and drop**

- 5.1 Vibration and shock
- 5.2 Drop test

**6.0 Environment**

- 6.1 Temperature and humidity
  - 6.1.1 Operating conditions
  - 6.1.2 Shipping conditions
- 6.2 Atmospheric pressure
- 6.3 Thermal shock

**7.0 Reliability**

- 7.1 Failure criteria
- 7.2 Failure rate
  - 7.2.1 Usage
  - 7.2.2 Components de-rating
- 7.3 CCFL life
- 7.4 ON/OFF cycle

**8.0 Safety**

- 8.1 Sharp edge requirement
- 8.2 Material
  - 8.2.1 Toxicity
  - 8.2.2 Flammability
- 8.3 Capacitors
- 8.4 Hazardous voltage

**9.0 Other requirements**

- 9.1 Smoke free design
- 9.2 National test lab requirement

## 10.0 Mechanical Characteristics

### ii Record of Revision

Version and Date	Page	Old description	New Description	Remark
0.1 2005/04/21	All	First Edition for Customer	All	
0.2 2005/06/22	8	Contrast ratio Min. target 400	Contrast ratio Min. target 700	Revised
0.2 2005/06/22	13	Lamp Connector / Backlight lamp Manufacturer: JST Type Part Number: BHSR-02VS-1 (2 pin), BHR-05VS-1 (5 pin) Mating Type Part Number: SM02B-BHSS-1(2 pin), SM04B-BHS-1 (5 pin)	Lamp Connector / Backlight lamp Manufacturer: YEONHO Type Part Number: 35001HS-02L (2 pins), 20015HS-05L (5 pins) Mating Type Part Number: 35001WR-02L (2 pins), 20015WR-05L (5 pins)	Revised
0.2 2005/06/22	22	CCFL standard current Min. Target: 3 mA	CCFL standard current Min. Target: 4 mA	Revised
0.2 2005/06/22	22	CCFL Frequency Typ. Target: 50 Max. Target: 60	CCFL Frequency Typ. Target: 55 Max. Target: 70	Revised
0.2 2005/06/22	22	CCFL Ignition Voltage Min. Target: TBD	CCFL Ignition Voltage Min. Target: 1600	Defined
0.2 2005/06/22	22	CCFL Ignition Voltage Min. Target: TBD	CCFL Ignition Voltage Min. Target: 1230	Defined
0.2 2005/06/22	22	CCFL Discharge Voltage Typ. Target: TBD Max. Target: TBD	CCFL Discharge Voltage Typ. Target: 744 Max. Target: 820	Defined
0.2 2005/06/22	22	CCFL Power consumption Typ. Target: TBD Max. Target: TBD	CCFL Power consumption Typ. Target: 31.3 Max. Target: 37	Defined
0.3 2005/06/29	21	Signal for Lamp connector Connector No. CN2 Pin No. 1 Color Gray Pin No. 4 Color Black Connector No. CN5 Pin No. 1 Color Gray Pin No. 4 Color Black	Signal for Lamp connector Connector No. CN2 Pin No. 1 <b>Color Pink</b> Pin No. 4 <b>Color Red</b> Connector No. CN5 Pin No. 1 <b>Color Pink</b> Pin No. 4 <b>Color Red</b>	Revised
0.3 2005/06/29	23	Vibration mode: New added	Vibration mode: <b>Random</b>	Added
0.3 2005/06/29	26	Mechanism Diagram Change	New Mechanism Diagram	Revised
0.3 2005/06/29	27	Mechanism Diagram Change	New Mechanism Diagram	Revised

## 1.0 Handling Precautions

- 1) Since front polarizer is easily damaged, pay attention not to scratch it.
- 2) Be sure to turn off power supply when inserting or disconnecting from input connector.
- 3) Wipe off water drop immediately. Long contact with water may cause discoloration or spots.
- 4) When the panel surface is soiled, wipe it with absorbent cotton or other soft cloth.
- 5) Since the panel is made of glass, it may break or crack if dropped or bumped on hard surface.
- 6) Since CMOS LSI is used in this module, take care of static electricity and insure human earth when handling.
- 7) Do not open nor modify the Module Assembly.
- 8) Do not press the reflector sheet at the back of the module to any directions.
- 9) In case if a module has to be put back into the packing container slot after once it was taken out from the container, do not press the center of the CCFL reflector edge. Instead, press at the far ends of the CCFL reflector edge softly. Otherwise the TFT module may be damaged.
- 10) At the insertion or removal of the Signal Interface Connector, be sure not to rotate nor tilt the Interface Connector of the TFT module.
- 11) After installation of the TFT module into an enclosure (Desktop monitor Bezel, for example), do not twist nor bend the TFT Module even momentary. At designing the enclosure, it should be taken into consideration that no bending/twisting forces are applied to the TFT module from outside. Otherwise the TFT module may be damaged.

## 2.0 General Description

This specification applies to the 20.1 inch Color TFT-LCD Module M201UN02 v.5.

The display supports the UXGA (1600(H) x 1200(V)) screen format and 16.7M colors (RGB 8-bits data).

All input signals are 2 Channel LVDS interface compatible.

This module does not contain an inverter card for backlight.

## 2.1 Display Characteristics

The following items are characteristics summary on the table under 25 °C condition:

ITEMS	Unit	SPECIFICATIONS
Screen Diagonal	[mm]	510(20.1")
Active Area	[mm]	408.0 (H) x 306.0 (V)
Pixels H x V		1600(x3) x 1200
Pixel Pitch	[mm]	0.255 (per one triad) x 0.255
Pixel Arrangement		R.G.B. Vertical Stripe
Display Mode		Normally Black
White Luminance	[cd/m <sup>2</sup> ]	300 cd/m <sup>2</sup> (Typ)
Contrast Ratio		1000 : 1 (Typ)
Optical Response Time ( Gray to Gray)	[msec]	16 (Typ)
Nominal Input Voltage VDD	[Volt]	+5.0 V
Power Consumption (VDD line + CCFL line)	[Watt]	45W(typ.) (w/o Inverter, All white pattern)
Weight	[Grams]	3300 (Max)
Physical Size	[mm]	432(W) x 331.5(H) x 25 Max(D)
Electrical Interface		Even/Odd R/G/B data, 3 sync signal, Clock
Support Color		16.7M colors (RGB 8-bit data )
Surface treatment		Anti-glare (3H)
Temperature Range		
Operating	[°C]	0 to +50
Storage (Shipping)	[°C]	-20 to +60

## 2.2 Functional Block Diagram

The following diagram shows the functional block of the 20.1 inches Color TFT-LCD Module:

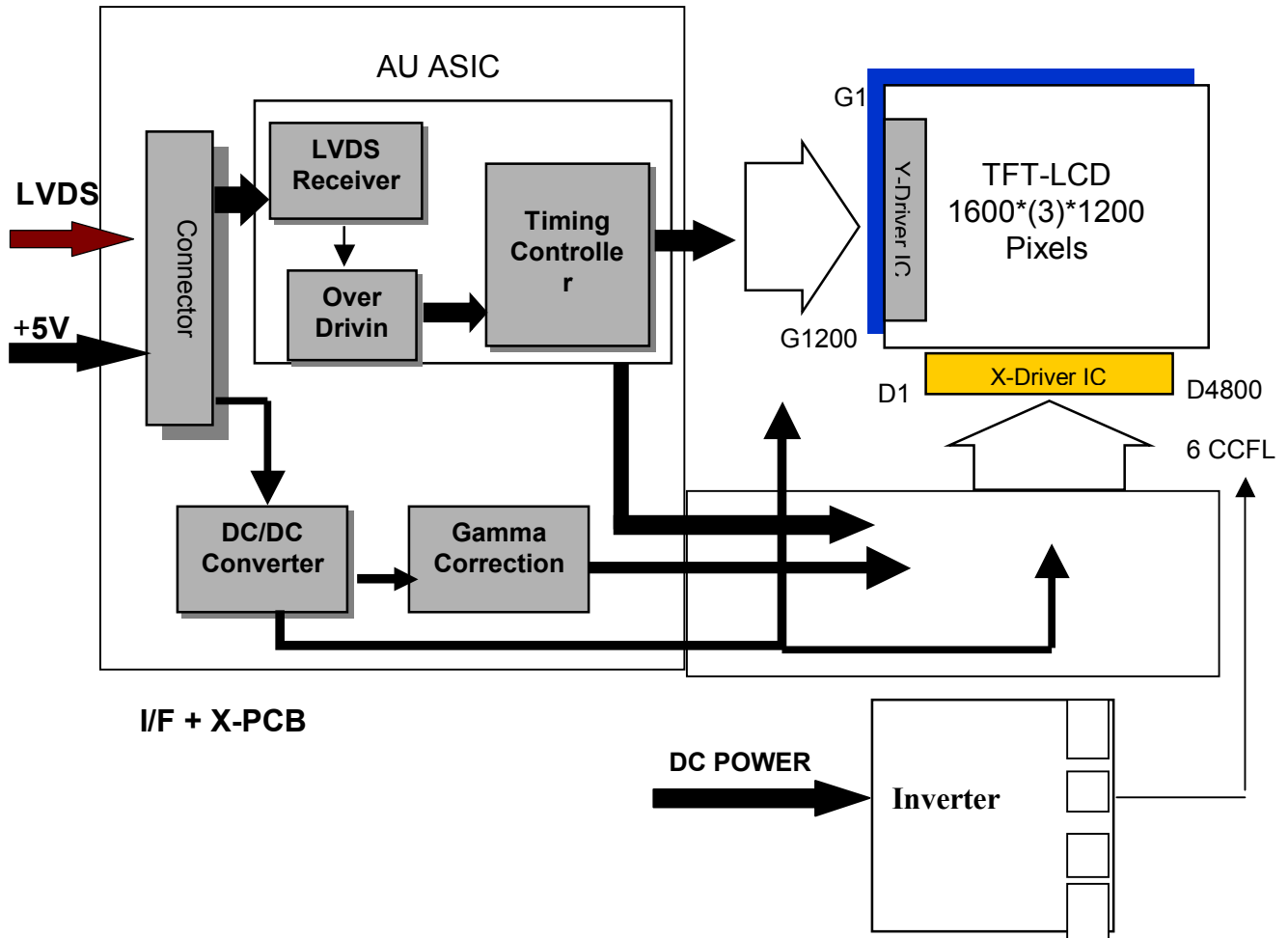

### 2.3 Optical Characteristics

The optical characteristics are measured under stable conditions at 25°C (Room Temperature):

Item	Unit	Conditions	Min.	Typ.	Max.
Viewing Angle	[degree]	Horizontal (Right)	75	85	-
	[degree]	CR = 10 (Left)		85	-
	[degree]	Vertical (Up)	75	85	-
	[degree]	CR = 10 (Down)		85	-
Contrast ratio		Normal Direction	700	1000	
Response Time (Note 1 & 4)	[msec]	Raising Time	-	11	15
	[msec]	Falling Time	-	5	7
	[msec]	Raising + Falling	-	16	22
	[msec]	Gray to Gray	-	8	
Color / Chromaticity Coordinates (CIE)		Red x	0.624	0.654	0.684
		Red y	0.301	0.331	0.361
		Green x	0.255	0.285	0.315
		Green y	0.559	0.589	0.619
		Blue x	0.109	0.139	0.169
		Blue y	0.044	0.074	0.104
Color Coordinates (CIE) White		White x	0.283	0.313	0.343
		White y	0.299	0.329	0.359
White Luminance at CCFL 7.0mA (central point)	[cd/m <sup>2</sup> ]		240	300	-
Luminance Uniformity (Note 2)	[%]		75	80	-
Crosstalk (in 60Hz) (Note 3)	[%]				1.5

Equipment      Pattern Generator, Power Supply, Digital Voltmeter, Luminance meter (PR 880, BM-5A , BM- 7 , & EZContrast\* )  
 Aperture        1° with 100cm VD or 2° with 50cm viewing distance  
 Test Point      Center (ISO point 22)  
 Environment    < 1 lux

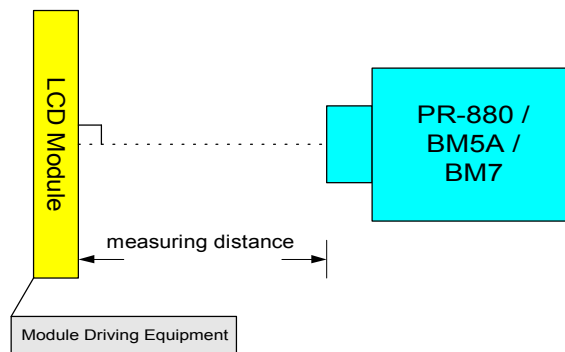

\* EZ Contrast is different measurement tool with very close viewing distance.

Note 1: Definition of Response time:



**Product Specification**

The output signals of photodetector are measured when the input signals are changed from “Black” to “White” (rising time), and from “White” to “Black” (falling time), respectively. The response time is interval between the 10% and 90% of amplitudes. Refer to figure as below.

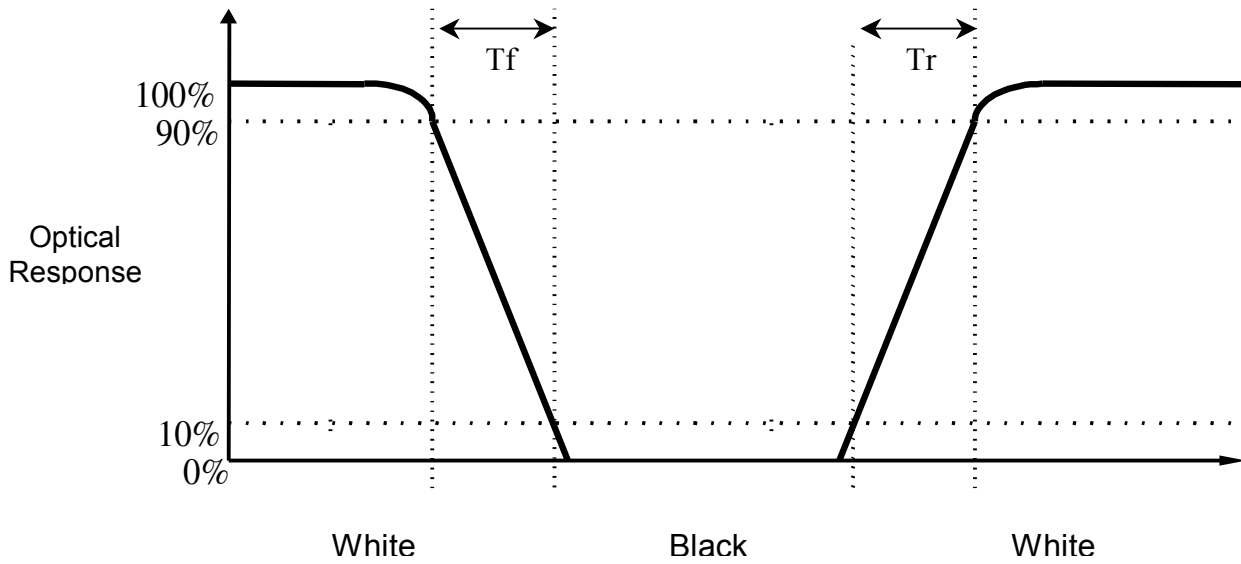

Note 2: Brightness uniformity of these 9 points is defined as below:

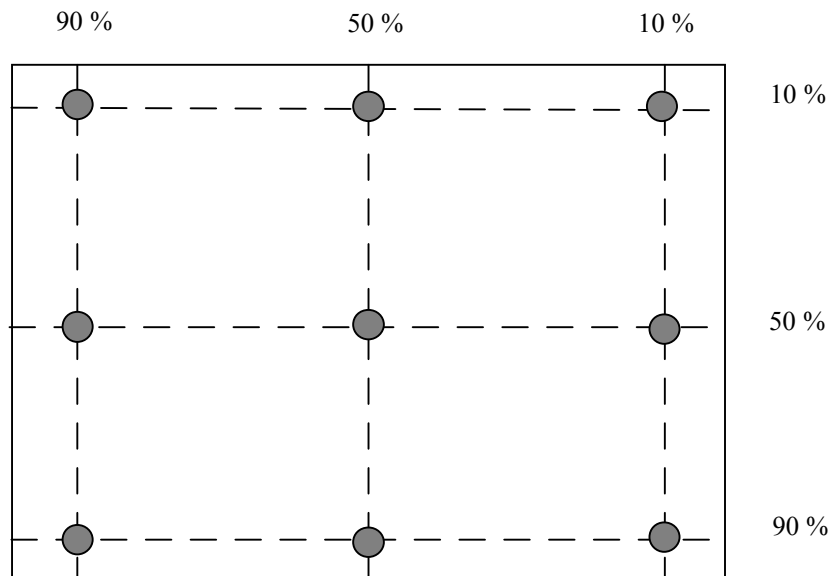

$$\text{Uniformity} = \frac{\text{Minimum Luminance in 9 Points (1-9)}}{\text{Maximum Luminance in 9 Points (1-9)}}$$

**Product Specification**

Note 3: Crosstalk is defined as below :

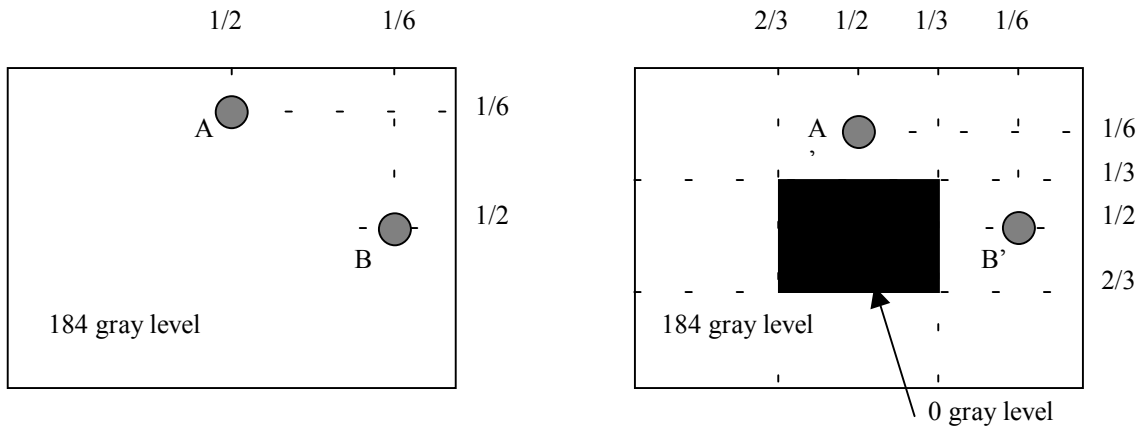

Unit: percentage of dimension of display area

$$|L_A - L_{A'}| / L_A \times 100\% = 1.5\% \text{ max.}, L_A \text{ and } L_B \text{ are brightness at location A and B}$$

$$|L_B - L_{B'}| / L_B \times 100\% = 1.5\% \text{ max.}, L_{A'} \text{ and } L_{B'} \text{ are brightness at location A' and B'}$$

Note 4: Over-Drive and Response time:

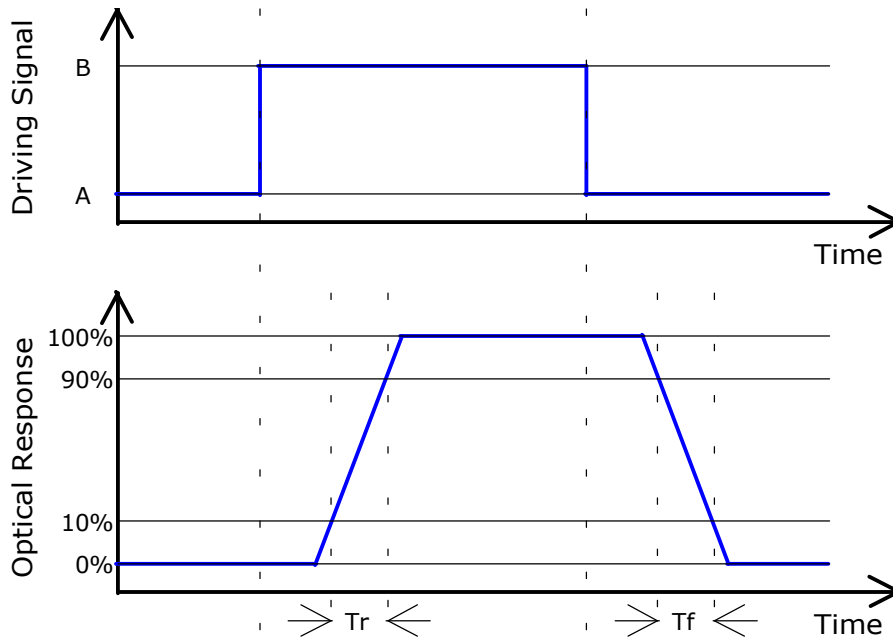

Algorithm:

$$|LevelA - LevelB| \geq 16 \text{ then } T_r \leq 16ms \ \& \ T_f \leq 16ms$$

### 2.4 Pixel format image

Following figure shows the relationship of the input signals and LCD pixel format.

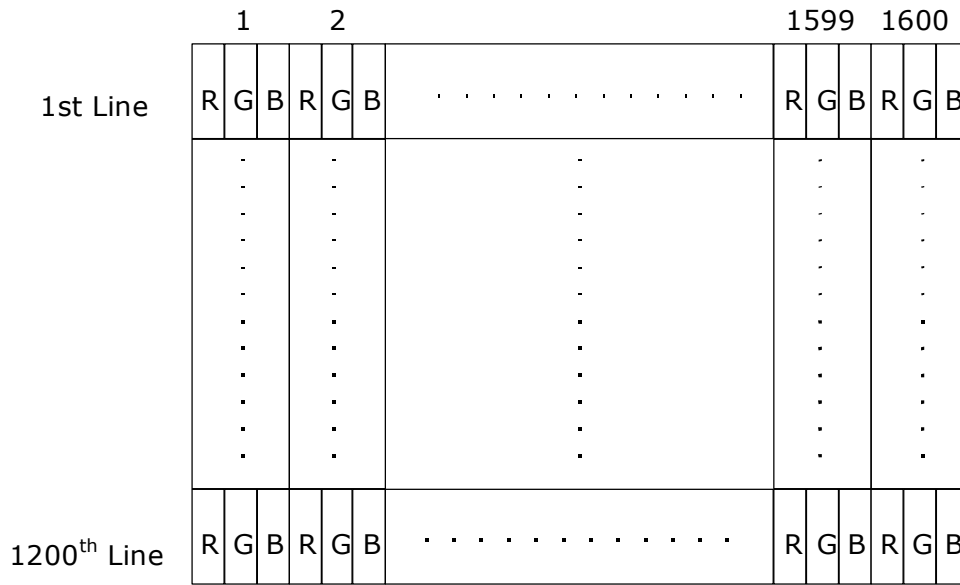

### 3.0 Electrical characteristics

#### 3.1 Absolute Maximum Ratings

Absolute maximum ratings of the module is as following:

Item	Symbol	Min	Max	Unit	Conditions
Logic/LCD Drive Voltage	VIN	-0.3	+6.0	[Volt]	
Select LVDS data order	SELLVDS	NC	NC	[Volt]	
CCFL Inrush current	ICFLL	-	40	[mA]	Note 1
CCFL Current	ICFL	-	8	[mA] rms	
Operating Temperature	TOP	0	+50	[°C]	Note 2
Operating Humidity	HOP	8	95	[%RH]	Note 2
Storage Temperature	TST	-20	+60	[°C]	Note 2
Storage Humidity	HST	8	95	[%RH]	Note 2

**Note 1 :** Duration=50 msec.

**Note 2 :** Maximum Wet-Bulb should be 39°C and No condensation.

#### Relative Humidity %

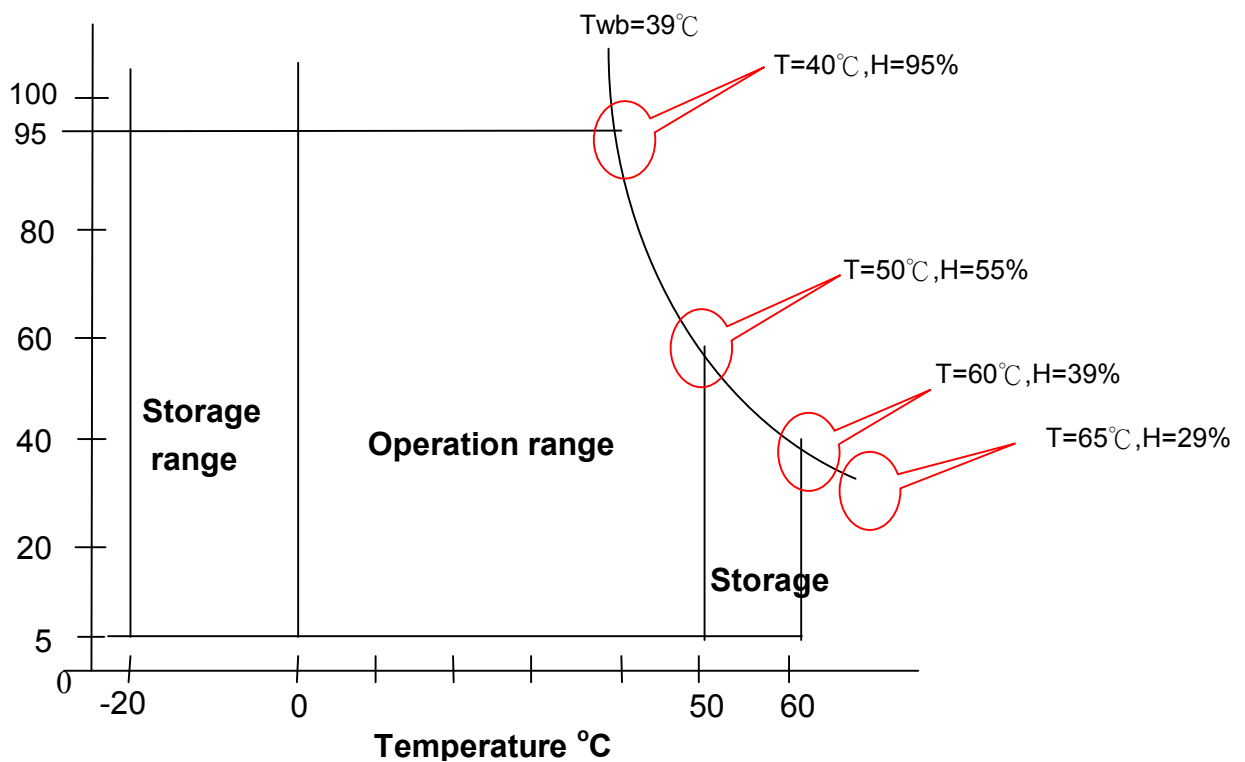

### 3.2 Connectors

Physical interface is described as for the connector on module.

These connectors are capable of accommodating the following signals and will be following components.

<b>Connector Name / Designation</b>	Interface Connector / Interface card
<b>Manufacturer</b>	JAE or compatible
<b>Type Part Number</b>	FI-XB30SSL-HF15 or MSBKT2407P30
<b>Mating Housing Part Number</b>	FI-X30S-H

<b>Connector Name / Designation</b>	Lamp Connector / Backlight lamp
<b>Manufacturer</b>	YEONHO
<b>Type Part Number</b>	35001HS-02L (2 pins), 20015HS-05L (5 pins)
<b>Mating Type Part Number</b>	35001WR-02L (2 pins), 20015WR-05L (5 pins)

### 3.3 Signal Pin

Pin#	Signal Name	Pin#	Signal Name
1	RxO0-	2	RxO0+
3	RxO1-	4	RxO1+
5	RxO2-	6	RxO2+
7	GND	8	RxOC-
9	RxOC+	10	RxO3-
11	RxO3+	12	RxE0-
13	RxE0+	14	GND
15	RxE1-	16	RxE1+
17	GND	18	RxE2-
19	RxE2+	20	RxEC-
21	RxEC+	22	RxE3-
23	RxE3+	24	GND
25	NC	26	NC
27	NC	28	Power
29	Power	30	Power

### 3.4 Signal Description

The module using a pair of LVDS receiver SN75LVDS82(Texas Instruments) or compatible. LVDS is a differential signal technology for LCD interface and high speed data transfer device. Transmitter shall be SN75LVDS83(negative edge sampling) or compatible. The first LVDS port(RxOxxx) transmits odd pixels while the second LVDS port(RxExxx) transmits even pixels.

PIN #	SIGNAL NAME	DESCRIPTION
1	RxO0-	Negative LVDS differential data input (Odd data)
2	RxO0+	Positive LVDS differential data input (Odd data)
3	RxO1-	Negative LVDS differential data input (Odd data)
4	RxO1+	Positive LVDS differential data input (Odd data)
5	RxO2-	Negative LVDS differential data input (Odd data, H-Sync,V-Sync,DSPTMG)
6	RxO2+	Positive LVDS differential data input (Odd data, H-Sync,V-Sync,DSPTMG)
7	GND	Power Ground
8	RxOC-	Negative LVDS differential clock input (Odd clock)
9	RxOC+	Positive LVDS differential clock input (Odd clock)
10	RxO3-	Negative LVDS differential data input (Odd data)
11	RxO3+	Positive LVDS differential data input (Odd data)
12	RxE0-	Negative LVDS differential data input (Even clock)
13	RxE0+	Positive LVDS differential data input (Even data)
14	GND	Power Ground
15	RxE1-	Positive LVDS differential data input (Even data)
16	RxE1+	Negative LVDS differential data input (Even data)
17	GND	Power Ground
18	RxE2-	Negative LVDS differential data input (Even data)
19	RxE2+	Positive LVDS differential data input (Even data)
20	RxEC-	Negative LVDS differential clock input (Even clock)
21	RxEC+	Positive LVDS differential clock input (Even clock)
22	RxE3-	Negative LVDS differential data input (Even data)
23	RxE3+	Positive LVDS differential data input (Even data)
24	GND	Power Ground
25	NC	-
26	NC	-
27	NC	-
28	POWER	Power
29	POWER	Power
30	POWER	Power

**Note:** Input signals of odd and even clock shall be the same timing.

LVDS DATA Name	Description
DSP	Display Timing: When the signal is high, the pixel data shall be valid to be displayed
V-S	Vertical Sync: Both Positive and Negative polarity are acceptable
H-S	Horizontal Sync: Both Positive and Negative polarity are acceptable

TI LVDS X'mitter SN75LVDS83	Module LVDS signal (interface connector pin7)
Signal Name	Low(open)
D0	Red0
D1	Red1
D2	Red2
D3	Red3
D4	Red4
D5	Red7
D6	Red5
D7	Green0
D8	Green1
D9	Green2
D10	Green6
D11	Green7
D12	Green3
D13	Green4
D14	Green5
D15	Blue0
D16	Blue6
D17	Blue7
D18	Blue1
D19	Blue2
D20	Blue3
D21	Blue4
D22	Blue5
D23	NA
D24	H Sync
D25	V Sync
D26	Display Timing
D27	Red6

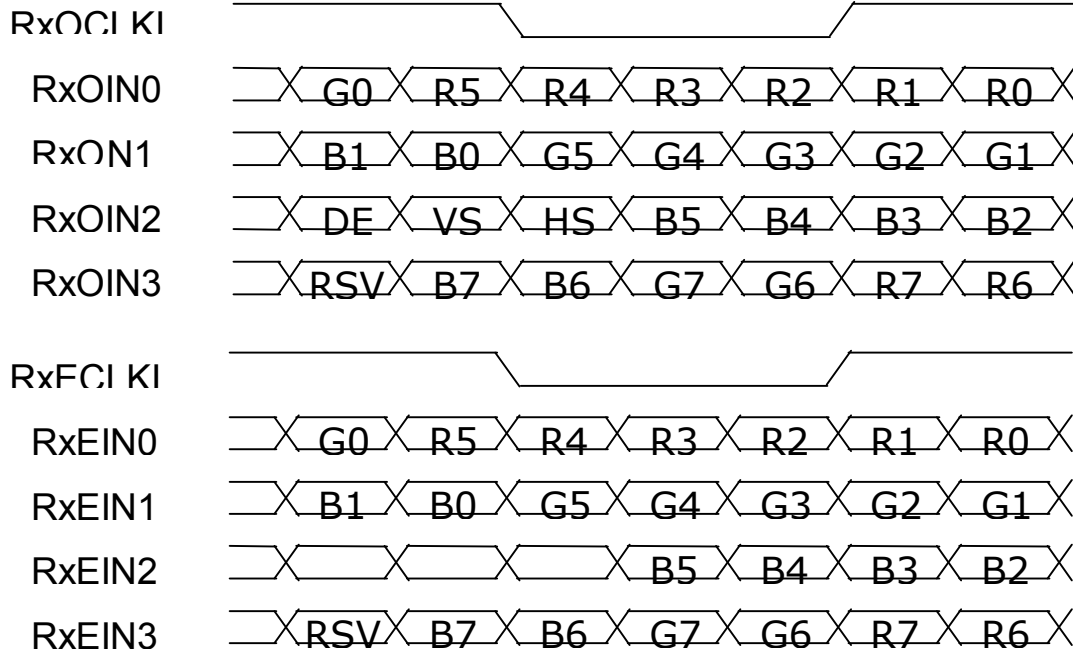

**Note: R/G/B data 7:MSB, R/G/B data 0:LSB**

O = "First Pixel Data"

E = "Second Pixel Data"



### 3.5 Signal Electrical Characteristics

Input signals shall be low or Hi-Z state when Vin is off

It is recommended to refer the specifications of SN75LVDS82DGG (Texas Instruments) in detail.

Each signal characteristics are as follows;

Parameter	Condition	Min	Max	Unit
Vth	Differential Input High Voltage(Vcm=+1.2V)		100	[mV]
Vtl	Differential Input Low Voltage(Vcm=+1.2V)	-100		[mV]

Note: The value of Vcm from LVDS transmitter should follow the following guide.

Parameter	Min	Typ.	Max	Unit
Vcm	+1.0	+1.2	+1.35	[V]

### 3.6 Interface Timings

Basically, interface timings described here is not actual input timing of LCD module but output timing of SN75LVDS82DGG (Texas Instruments) or equivalent.

#### 3.6.1 Timing Characteristics (DE mode only)

Signal	Item	Symbol	Min	Typ	Max	Unit
Vertical Section	Period	Tv	1211	-	2048	Th
	Active	Tdisp(v)	1200	1200	1200	Th
	Blanking	Tbp(v)+Tfp(v)+PWvs	11	-	848	Th
Horizontal Section	Period	Th	860	-	1500	Tclk
	Active	Tdisp(h)	800	800	800	Tclk
	Blanking	Tbp(h)+Tfp(h)+PWhs	60	-	700	Tclk
Clock	Period	Tclk	12	-	-	ns
	Frequency	Freq	64	81	83	MHz

### 3.6.2 Timing Definition

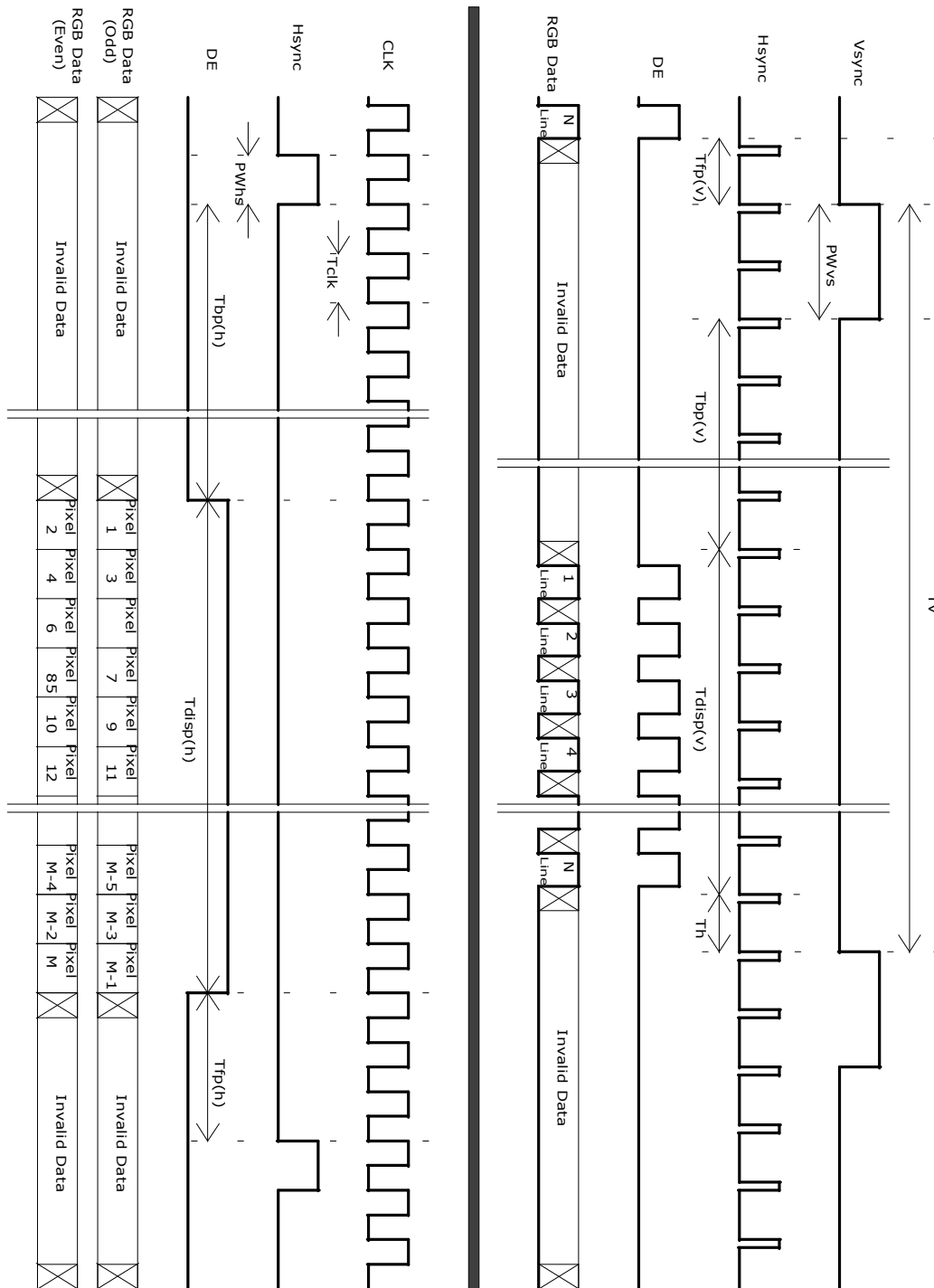

Note :1600X1200 at 60 Hz (VESA STANDARD)

### 3.7 Power Consumption

Input power specifications are as follows;

Symbol	Parameter	Min	Typ	Max	Units	Condition
VDD	Logic/LCD Drive Voltage	4.5	5	5.5	[Volt]	
IDD	VDD current		1300	1500	[mA]	
IIDD	Inrush VDD current			7	[A]	t < 80us
PDD	VDD Power		6.5	8.3	[Watt]	Vin=5V, All White Pattern
VDDrp	Allowable Logic/LCD Drive Ripple Voltage			100	[mV] p-p	
VDDns	Allowable Logic/LCD Drive Ripple Noise			100	[mV] p-p	

### 3.8 Power ON/OFF Sequence

Vin power and lamp on/off sequence is as follows. Interface signals are also shown in the chart. Signals from any system shall be Hi-Z state or low level when Vin is off.

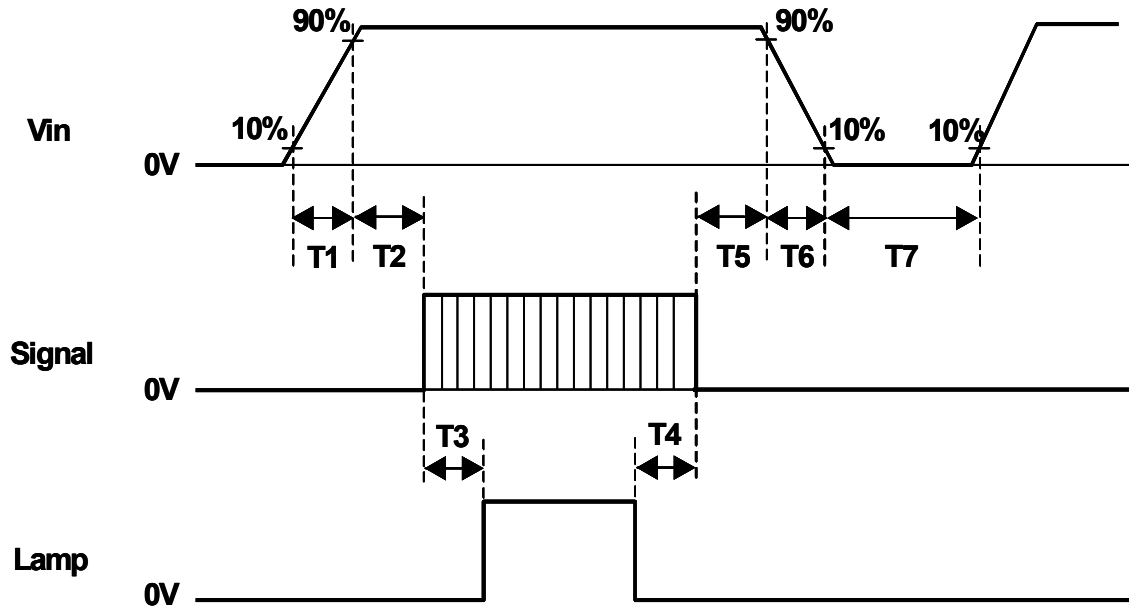

Symbol	Values			Unit
	Min	Typ	Max	
T1	0.5	-	10	[ms]
T2	0.5	40	50	[ms]
T3	200	-	-	[ms]
T4	200	-	-	[ms]
T5	0.5	16	50	[ms]
T6	0.5	-	10	[ms]
T7	1000	-	-	[ms]

## 4.0 Backlight Characteristics

### 4.1 Signal for Lamp connector

	Connector No.	Pin No.	Color	Function
Upper	CN2	1	Pink	High Voltage (Lamp 1)
		2	Sky Blue	High Voltage (Lamp 3)
		3	NC	NC
		4	Red	Low Voltage (Lamp 1)
		5	Dark Blue	Low Voltage (Lamp 3)
	CN3	1	White	High Voltage (Lamp 2)
		2	White	Low Voltage (Lamp 2)
Lower	CN4	1	White	High Voltage (Lamp 5)
		2	White	Low Voltage (Lamp 5)
	CN5	1	Pink	High Voltage (Lamp 6)
		2	Sky Blue	High Voltage (Lamp 4)
		3	NC	NC
		4	Red	Low Voltage (Lamp 6)
	5	Dark Blue	Low Voltage (Lamp 4)	

#### Upper

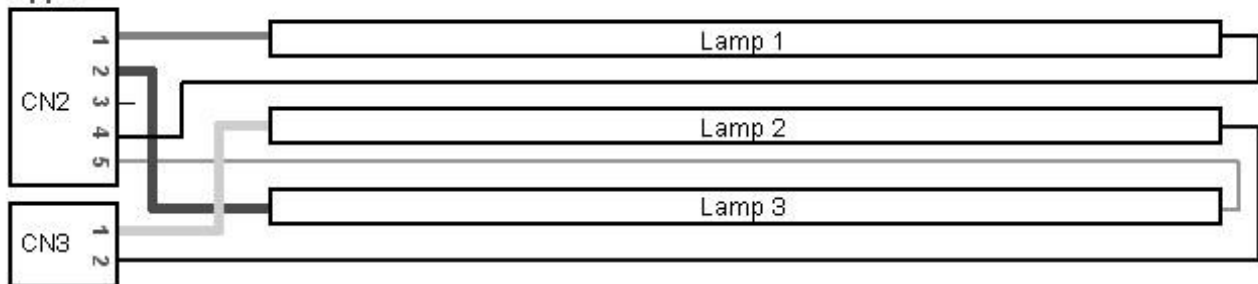

#### Lower

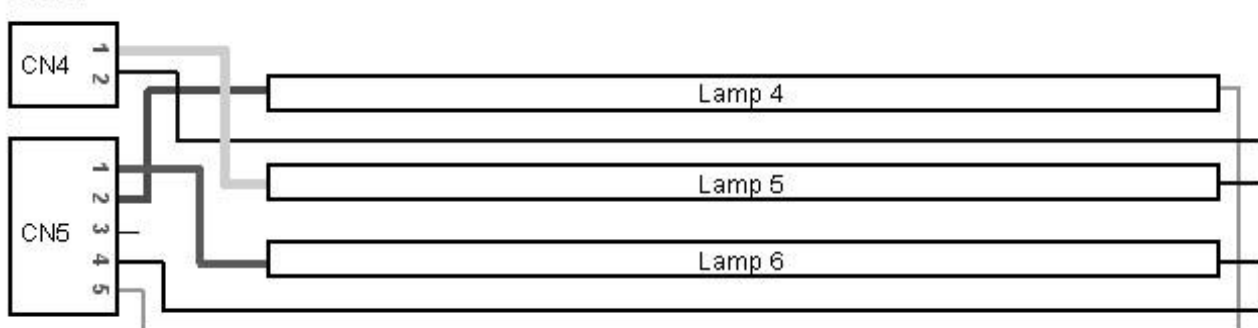

**4.2 Parameter guide line for CFL Inverter**

Symbol	Parameter	Min	Typ	Max	Units	Condition
ISCFL	CCFL standard current	4.0	7.0	8.0	[mA] rms	(Ta=25°C)
IRCFL	CCFL operation range	6.5	7.0	7.5	[mA] rms	(Ta=25°C)
fCFL	CCFL Frequency	40	55	70	[KHz]	(Ta=25°C) Note 1
ViCFL (0°C)	CCFL Ignition Voltage Note 4	1600			[Volt] rms	(Ta=0°C) Note 2
ViCFL (25°C)	CCFL Ignition Voltage Note 4	1230			[Volt] rms	(Ta=25°C) Note 2
VCFL	CCFL Discharge Voltage (Reference) @7mA		744	820	[Volt] rms	(Ta=25°C) Note 3
PCFL	CCFL Power consumption @7mA		31.3	37	[Watt]	(Ta=25°C) Note 3

Note 1: CCFL Frequency should be carefully determined to avoid interference between inverter and TFT LCD

Note 2: CCFL inverter should be able to give out a power that has a generating capacity of over 1700 voltage. Lamp units need 1700 voltage minimum for ignition

Note 3: Calculator value for reference (ICFL×VCFL×6=PCFL)

Note 4: (measure for both end of lamp wire)

## 5.0 Vibration, Shock, and Drop

### 5.1 Vibration & Shock

<b>Vibration mode</b>	Random
<b>Acceleration (Grms)</b>	1.5
<b>Frequency (Hz)</b>	10~200
<b>Active time (min)</b>	30 for each axis (X, Y, Z)

### 5.2 Shock Test Spec:

<b>Acceleration (G) -a</b>	50
<b>Active time -b</b>	20
<b>Wave form</b>	half-sin
<b>Times</b>	1

Direction:  $\pm X$ ,  $\pm Y$ ,  $\pm Z$

### 5.3 Drop test

Package test: The drop height is 60 cm.

## 6.0 Environment

The display module will meet the provision of this specification during operating condition or after storage or shipment condition specified below. Operation at 10% beyond the specified range will not cause physical damage to the unit.

### 6.1 Temperature and Humidity

#### 6.1.1 Operating Conditions

The display module operates error free, when operated under the following conditions;

Temperature	0 °C to 50 °C
Relative Humidity	8% to 95%
Wet Bulb Temperature	39.0 °C

### 6.1.2 Shipping Conditions

The display module operates error free, after the following conditions;

Temperature	-20 °C to 60 °C
Relative Humidity	8% to 95%
Wet Bulb Temperature	39.0 °C

### 6.2 Atmospheric Pressure

The display assembly is capable of being operated without affecting its operations over the pressure range as following specified;

	Pressure	Note
Maximum Pressure	1040hPa	0m = sea level
Minimum Pressure	674hPa	3048m = 10.000 feet

Note : Non-operation attitude limit of this display module = 30,000 feet. = 9145 m.

### 6.3 Thermal Shock

The display module will not sustain damage after being subjected to 100 cycles of rapid temperature change. A cycle of rapid temperature change consists of varying the temperature from -20°C to 60°C, and back again.

<b>Thermal shock cycle</b>	-20 °C for 30min 60 °C for 30min
----------------------------	-------------------------------------

Power is not applied during the test. After temperature cycling, the unit is placed in normal room ambient for at least 4 hours before powering on.

## 7.0 Reliability

This display module and the packaging of that will comply following standards.

### 7.1 Failure Criteria

The display assembly will be considered as failing unit when it no longer meets any of the requirements stated in this specification. Only as for maximum white luminance, following criteria is applicable.

**Note : Maximum white Luminance shall be 150 cd/m<sup>2</sup> or more.**

### 7.2 Failure Rate

The average failure rate of the display module (from first power-on cycle till 1,000 hours later) will not exceed 1.0%.

The average failure rate of the display module from 1,000 hours until 16,000 hours will not exceed 0.7% per 1000 hours.



### 7.2.1 Usage

The assumed usage for the above criteria is:

- 220 power-on hours per month
- 500 power on/off cycles per month
- Maximum brightness setting
- Operation to be within office environment (25°C typical)

### 7.2.2 Component De-rating

All the components used in this device will be checked the load condition to meet the failure rate criteria.

### 7.3 CCFL Life

The assumed CCFL Life will be longer than 50,000 hours, typical value is 50,000 hours under stable condition at 25 ± 5°C;

Standard current at 7.0 ± 0.5mA.

Definition of life: brightness becomes 50% or less than the minimum luminance value of CCFL.

### 7.4 ON/OFF Cycle

The display module will be capable of being operated over the following ON/OFF Cycles.

ON/OFF	Value	Cycles
+Vin and CCFL power	30,000	10 seconds on / 10 seconds off

## 8.0 Safety

### 8.1 Sharp Edge Requirements

There will be no sharp edges or comers on the display assembly that could cause injury.

### 8.2 Materials

#### 8.2.1 Toxicity

There will be no carcinogenic materials used anywhere in the display module. If toxic materials are used, they will be reviewed and approved by the responsible AUO Toxicologist.

#### 8.2.2 Flammability

All components including electrical components that do not meet the flammability grade UL94-V1 in the module will complete the flammability rating exception approval process. The printed circuit board will be made from material rated 94-V1 or better. The actual UL flammability rating will be printed on the printed circuit board.

### 8.3 Capacitors

If any polarized capacitors are used in the display assembly, provisions will be made to keep them from being inserted backwards.

### 9.0 Other requirements

#### 9.1 National Test Lab Requirement

The display module will satisfy all requirements for compliance to

<b>UL 1950, First Edition</b>	U.S.A. Information Technology Equipment
<b>CSA C22.2 No.950-M89</b>	Canada, Information Technology Equipment
<b>EEC 950</b>	International, Information Technology Equipment
<b>EN 60 950</b>	International, Information Processing Equipment (European Norm for IEC950)

#### 9.2 Label

##### 9.2.1 Product label

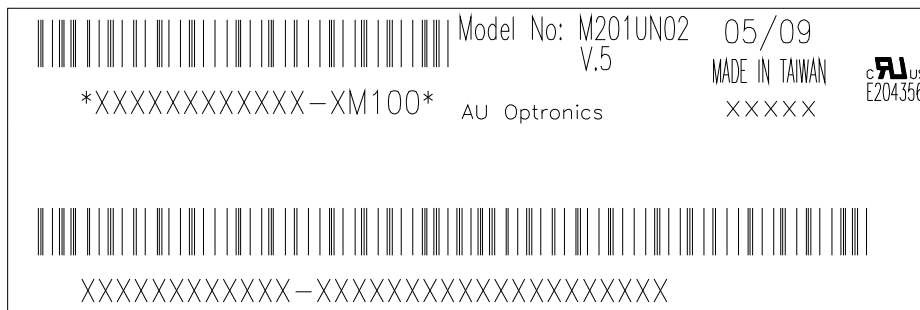

### 10.0 Mechanical Characteristics

