



# Product Specification

M240HW02 V1

AU OPTRONICS CORPORATION

(V ) Preliminary Specification

( ) Final Specification

<b>Module</b>	24.0" Color TFT-LCD
<b>Model Name</b>	M240HW02 V1

Customer	Date
_____	_____
<b>Approved by</b>	
_____	_____
<p>Note: This Specification is subject to change without notice.</p>	

Approved by	Date
<u>WinnieChang</u>	<u>2010/03/11</u>
<b>Prepared by</b>	
<u>AlanCHLiu</u>	<u>2010/03/04</u>
<p>Desktop Display Business Group / AU Optronics corporation</p>	

## Contents

<b>1.0 Handling Precautions.....</b>	<b>4</b>
<b>2.0 General Description.....</b>	<b>4</b>
2.1 Display Characteristics .....	5
2.2 Optical Characteristics .....	6
<b>3.0 Functional Block Diagram.....</b>	<b>10</b>
<b>4.0 Absolute Maximum Ratings.....</b>	<b>11</b>
4.1 TFT LCD Module .....	11
4.2 Backlight Unit.....	11
4.3 Absolute Ratings of Environment.....	11
<b>5.0 Electrical characteristics .....</b>	<b>12</b>
5.1 TFT LCD Module .....	12
5.1.1 Power Specification .....	12
5.1.2 Signal Electrical Characteristics .....	13
5.2 Backlight Unit.....	14
<b>6.0 Signal Characteristic .....</b>	<b>16</b>
6.1 Pixel Format Image.....	16
6.2 The input data format.....	16
6.3 Signal Description .....	17
6.4 Timing Characteristics .....	19
6.5 Timing diagram .....	20
6.6 Power ON/OFF Sequence .....	21
<b>7.0 Connector &amp; Pin Assignment.....</b>	<b>22</b>
7.1 TFT LCD Module .....	22
7.1.1 Pin Assignment.....	22
7.2 Connector on Backlight Unit.....	22
7.2.1 Signal for Lamp connector.....	22
<b>8.0 Reliability Test.....</b>	<b>24</b>
<b>9.0 Shipping Label .....</b>	<b>25</b>



**Record of Revision**

<b>Version and Date</b>	<b>Page</b>	<b>Old description</b>	<b>New Description</b>	<b>Remark</b>
0.1 2010/03/04	All	First Edition for Customer	All	

## 1.0 Handling Precautions

- 1) Since front polarizer is easily damaged, pay attention not to scratch it.
- 2) Be sure to turn off power supply when inserting or disconnecting from input connector.
- 3) Wipe off water drop immediately. Long contact with water may cause discoloration or spots.
- 4) When the panel surface is soiled, wipe it with absorbent cotton or other soft cloth.
- 5) Since the panel is made of glass, it may break or crack if dropped or bumped on hard surface.
- 6) Since CMOS LSI is used in this module, take care of static electricity and insure human earth when handling.
- 7) Do not open or modify the Module Assembly.
- 8) Do not press the reflector sheet at the back of the module to any directions.
- 9) In case if a Module has to be put back into the packing container slot after once it was taken out from the container, do not press the center of the CCFL reflector edge. Instead, press at the far ends of the CCFL Reflector edge softly. Otherwise the TFT Module may be damaged.
- 10) At the insertion or removal of the Signal Interface Connector, be sure not to rotate nor tilt the Interface Connector of the TFT Module.
- 11) After installation of the TFT Module into an enclosure, do not twist nor bend the TFT Module even momentary. At designing the enclosure, it should be taken into consideration that no bending/twisting forces are applied to the TFT Module from outside. Otherwise the TFT Module may be damaged.
- 12) Cold cathode fluorescent lamp in LCD contains a small amount of mercury. Please follow local ordinances or regulations for disposal.
- 13) Small amount of materials having no flammability grade is used in the LCD module. The LCD module should be supplied by power complied with requirements of Limited Power Source (IEC60950 or UL1950), or be applied exemption.
- 14) The LCD module is designed so that the CCFL in it is supplied by Limited Current Circuit (IEC60950 or UL1950). Do not connect the CCFL in Hazardous Voltage Circuit.

## 2.0 General Description

This specification applies to the 24 inch-wide Color TFT-LCD Module M240HW02. The display supports the Full HD - 1920(H) x 1080(V) screen format and 16.7M colors (RGB 8-bits data). All input signals are dual channel LVDS interface and this module doesn't contain an inverter board for backlight.

## 2.1 Display Characteristics

The following items are characteristics summary on the table under 25°C condition:

ITEMS	Unit	SPECIFICATIONS
Screen Diagonal	[mm]	609.7(24.0")
Active Area	[mm]	531.36 (H) x 298.89 (V)
Pixels H x V		1920(x3) x 1080
Pixel Pitch	[um]	276.75 (per one triad) x276.75
Pixel Arrangement		R.G.B. Vertical Stripe
Display Mode		VA Mode, Normally Black
White Luminance ( Center )	[cd/m <sup>2</sup> ]	250 cd/m <sup>2</sup> (Typ.)
Contrast Ratio		3000 (Typ.)
Optical Response Time	[msec]	25ms (Typ., on/off)
Nominal Input Voltage VDD	[Volt]	+5.0 V
Power Consumption (VDD line + CCFL line)	[Watt]	27 (Typ.) (without inverter, all black pattern)
Weight	[g]	2050 (Typ.)
Physical Size	[mm]	556.0 (W) x 323.2 (H) x 11.5 (D) typ
Electrical Interface		Dual channel LVDS
Support Color		16.7M colors (RGB 8-bit)
Surface Treatment		Anti-Glare, 3H
Temperature Range Operating Storage (Shipping)	[°C] [°C]	0 to +50 -20 to +60
RoHS Compliance		RoHS Compliance

## 2.2 Optical Characteristics

The optical characteristics are measured under stable conditions at 25°C :

Item	Unit	Conditions	Min.	Typ.	Max.	Note
Viewing Angle	[degree]	Horizontal (Right) CR = 10 (Left)	150	178	- -	<b>2</b>
		Vertical (Up) CR = 10 (Down)	150	178	- -	
Contrast ratio		Normal Direction	1800	3000	-	<b>3</b>
Response Time	[msec]	Raising Time (T <sub>rR</sub> )	-	16	25	<b>4</b>
		Falling Time (T <sub>rF</sub> )	-	9	15	
		Raising + Falling	-	25	40	
Color / Chromaticity Coordinates (CIE)		Red x		TBD		<b>5</b>
		Red y		TBD		
		Green x		TBD		
		Green y		TBD		
		Blue x		TBD		
		Blue y		TBD		
Color Coordinates (CIE) White		White x	0.283	0.313	0.343	
		White y	0.299	0.329	0.359	
Central Luminance	[cd/m <sup>2</sup> ]		200	250	-	<b>6</b>
Luminance Uniformity	[%]		75	80	-	<b>7</b>
Crosstalk (in 60Hz)	[%]				1.5	<b>8</b>
Flicker	dB				-20	<b>9</b>

## Note 1: Measurement method

The LCD module should be stabilized at given temperature for 30 minutes to avoid abrupt temperature change during measuring (at surface 35°C). In order to stabilize the luminance, the measurement should be executed after lighting Backlight for 30 minutes in a stable, windless and dark room.

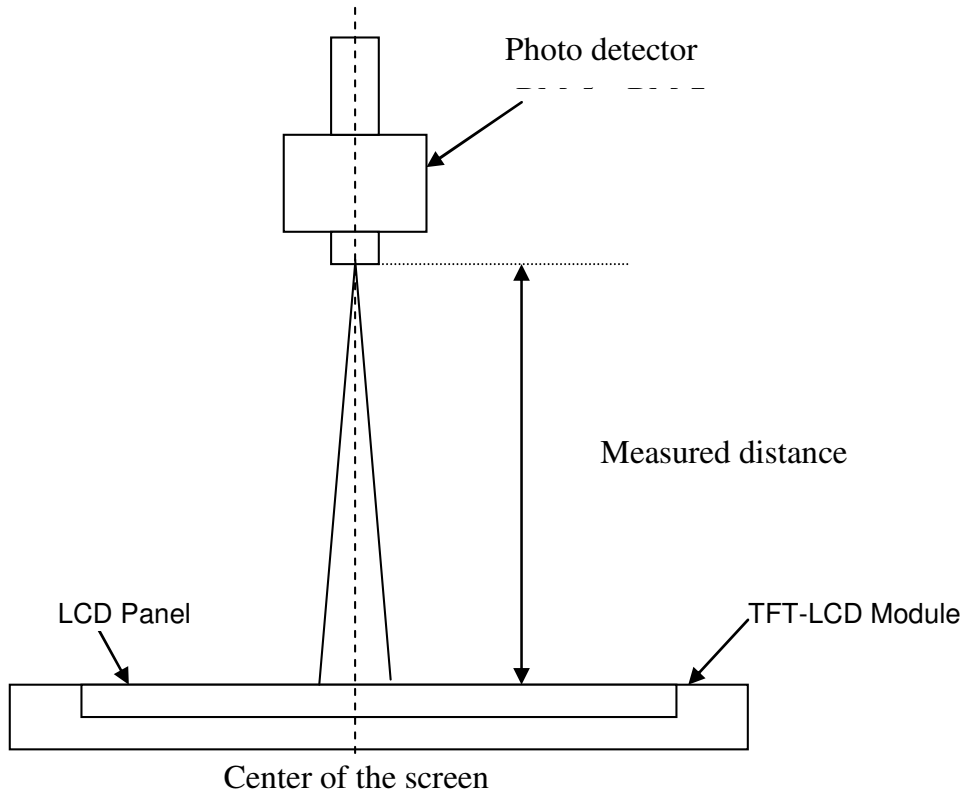

## Note 2: Definition of viewing angle measured by ELDIM (EZContrast 88)

Viewing angle is the measurement of contrast ratio  $\geq 10$ , at the screen center, over a 180° horizontal and 180° vertical range (off-normal viewing angles). The 180° viewing angle range is broken down as follows; 90° ( $\theta$ ) horizontal left and right and 90° ( $\phi$ ) vertical, high (up) and low (down). The measurement direction is typically perpendicular to the display surface with the screen rotated about its center to develop the desired measurement viewing angle.

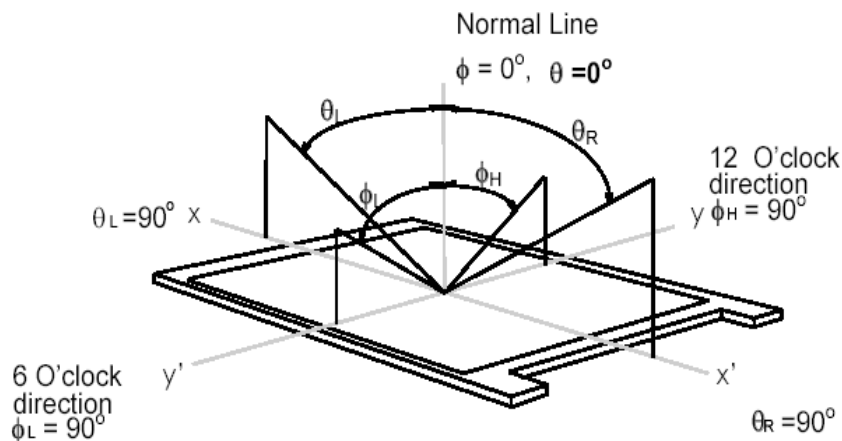

**Note 3: Contrast ratio** is measured by TOPCON SR-3

**Note 4: Definition of Response time** measured by Westar TRD-100A

The output signals of photo detector are measured when the input signals are changed from “Full Black” to “Full White” (rising time,  $Tr_R$ ), and from “Full White” to “Full Black” (falling time,  $Tf_F$ ), respectively. The response time is interval between the 10% and 90% (1 frame at 60 Hz) of amplitudes.

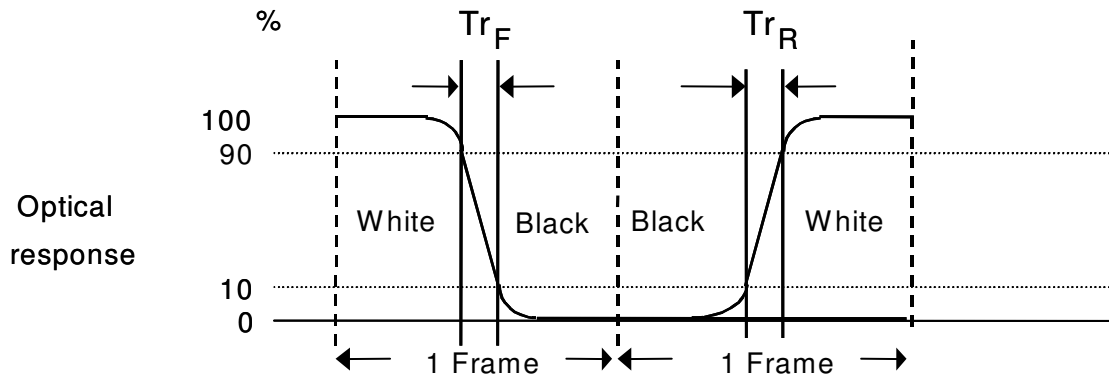

$Tr_R + Tf_F = 25 \text{ msec (typ.)}$ .

**Note 5: Color chromaticity and coordinates (CIE)** is measured by TOPCON SR-3

**Note 6: Central luminance** is measured by TOPCON SR-3

**Note 7: Luminance uniformity of these 9 points is defined as below and** measured by TOPCON SR-3

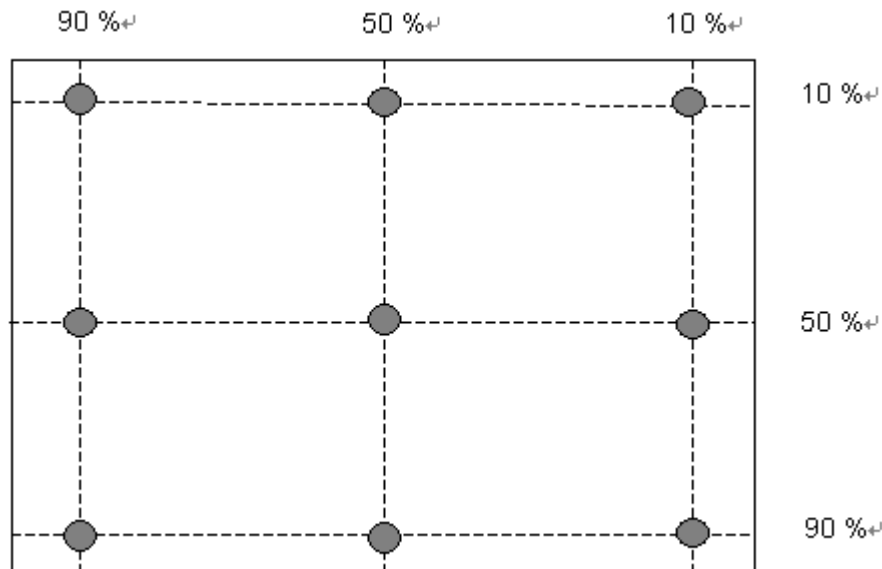

$$\text{Uniformity} = \frac{\text{Minimum Luminance in 9 points (1 - 9)}}{\text{Maximum Luminance in 9 Points (1 - 9)}}$$



**Note 8: Crosstalk is defined as below and measured by TOPCON SR-3**

$$CT = | YB - YA | / YA \times 100 (\%)$$

Where

YA = Luminance of measured location without gray level 0 pattern (cd/m<sup>2</sup>)

YB = Luminance of measured location with gray level 0 pattern (cd/m<sup>2</sup>)

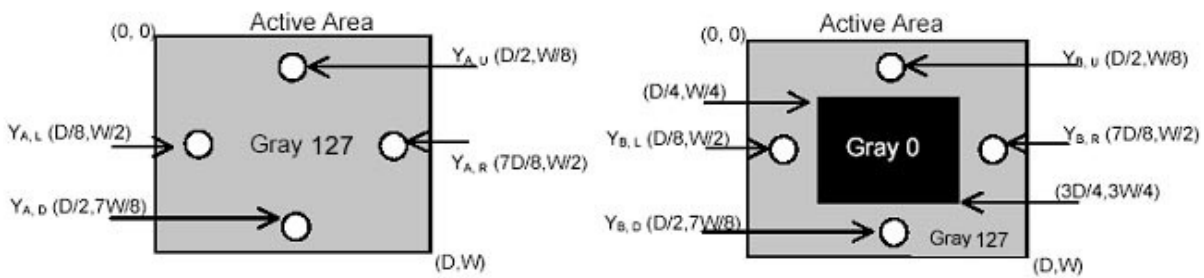

**Note 9: Test Pattern: Subchecker Pattern** measured by TOPCON SR-3

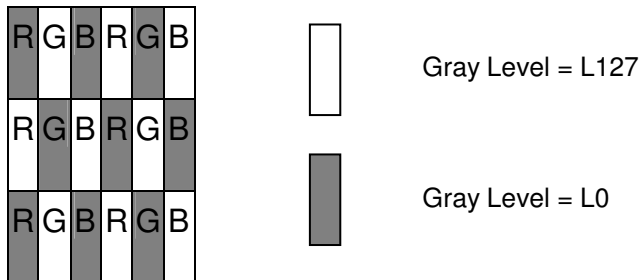

Method: Record dBV & DC value with TRD-100

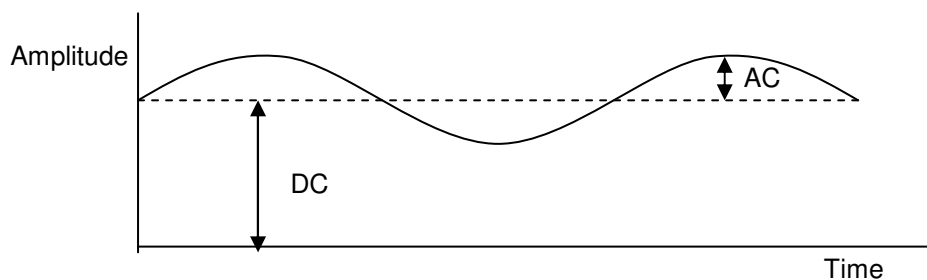

$$\text{Flicker (dB)} = 20 \log \frac{\text{AC Level (at 30 Hz)}}{\text{DC Level}}$$

## 3.0 Functional Block Diagram

The following diagram shows the functional block of the 24.0 inch Color TFT-LCD Module:

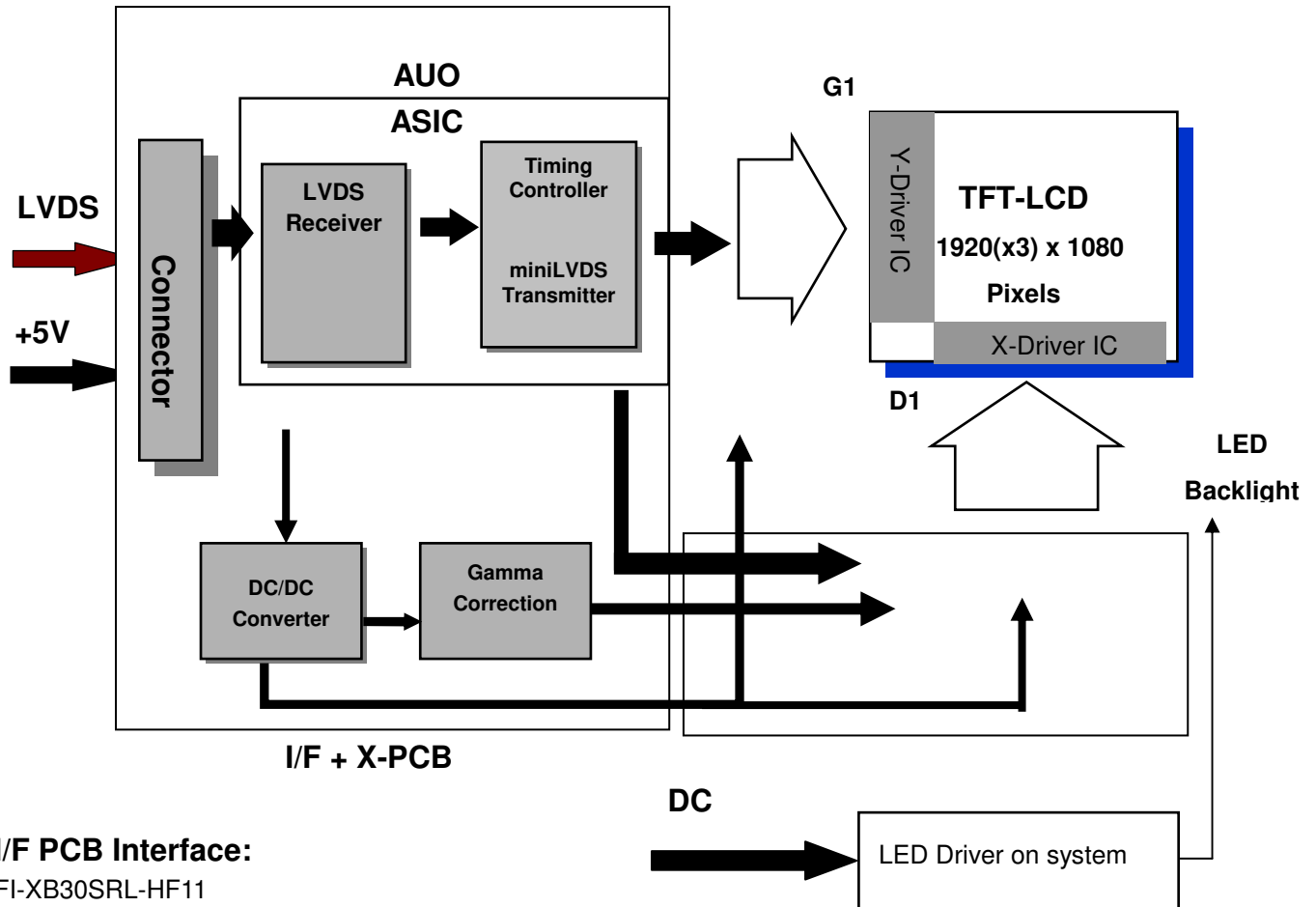

### I/F PCB Interface:

FI-XB30SRL-HF11

093F30-B0T01A

### Mating Type:

FI-X30HL(Locked Type)

## 4.0 Absolute Maximum Ratings

Absolute maximum ratings of the module are as following:

### 4.1 TFT LCD Module

Item	Symbo	Min	Max	Unit	Condition
Logic/LCD Drive	VDD	0	6.0	[Volt]	<b>Note 1,2</b>

### 4.2 Backlight Unit

Item	Symbol	Min	Max	Unit	Conditions
LED Current	ICFL	-	150	[mA]	<b>Note 1,2</b>

### 4.3 Absolute Ratings of Environment

Item	Symbol	Min.	Max.	Unit	Conditions
Operating Temperature	TOP	0	+50	[°C]	<b>Note 3</b>
Operation Humidity	HOP	5	90	[%RH]	
Storage Temperature	TST	-20	+60	[°C]	
Storage Humidity	HST	5	90	[%RH]	

**Note 1:** With in Ta (25°C)

**Note 2:** Permanent damage to the device may occur if exceeding maximum values

**Note 3:** For quality performance, please refer to AUO IIS(Incoming Inspection Standard).

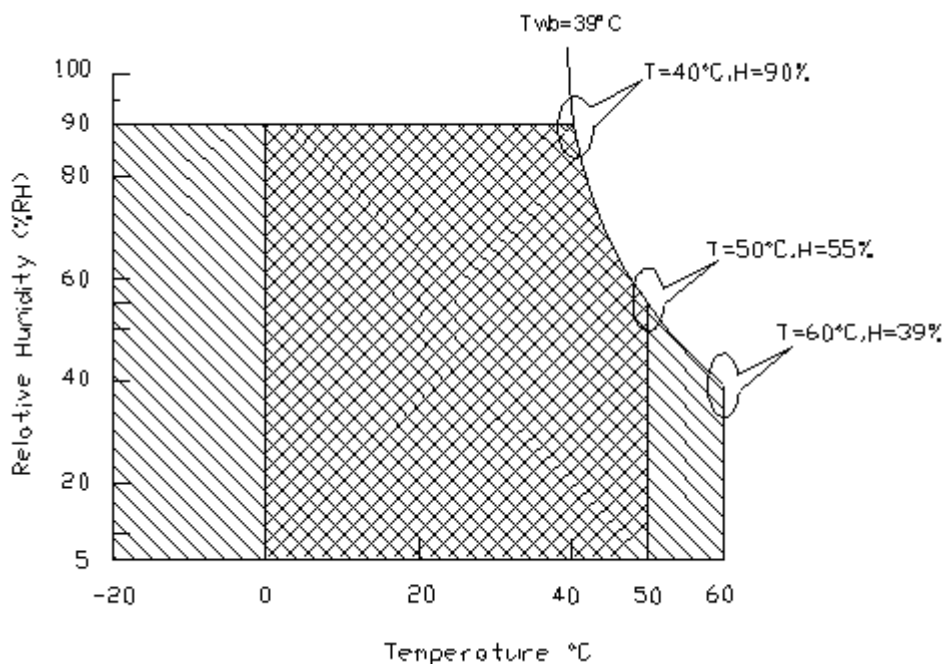

Operating Range



Storage Range



## 5.0 Electrical characteristics

### 5.1 TFT LCD Module

#### 5.1.1 Power Specification

Input power specifications are as following:

Symbol	Parameter	Min	Typ	Max	Unit	Conditions
VDD	Logic/LCD Drive Voltage	4.5	5.0	5.5	[Volt]	+/-10%
IDD1	Input Current	-	0.9	1.2	[A]	VDD= 5.0V, All white Pattern, At 60Hz
PDD1	VDD Power	-	4.5	6	[Watt]	VDD= 5.0V, All white Pattern, At 60Hz
IRush	Inrush Current	-	-	3	[A]	<b>Note 1</b>
VDDrp	Allowable Logic/LCD Drive Ripple Voltage	-	-	300	[mV] p-p	VDD= 5.0V, All white Pattern At 60Hz

**Note 1:** Measurement conditions:

The duration of rising time of power input is 470 us.

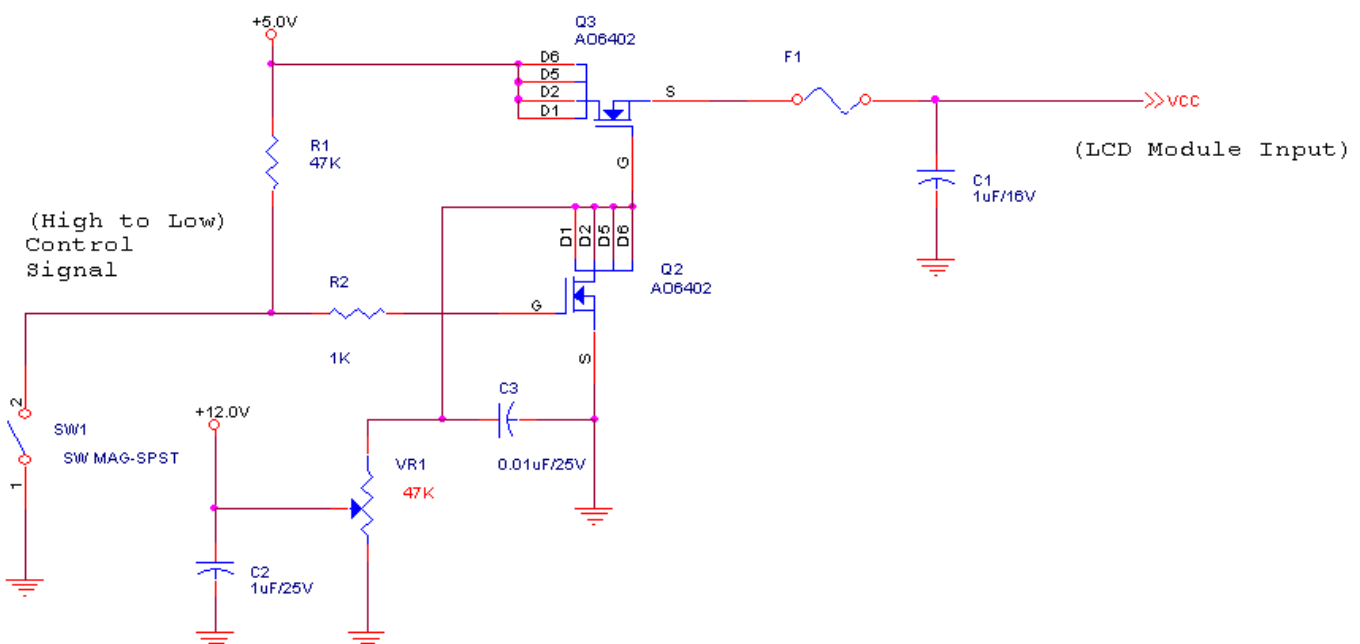
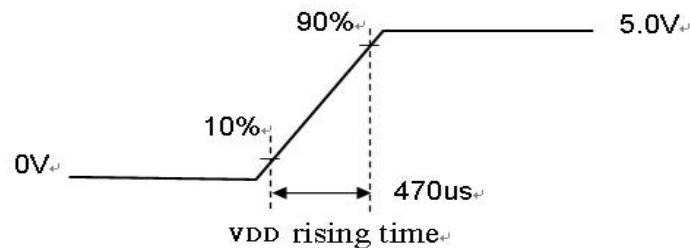

## 5.1.2 Signal Electrical Characteristics

Input signals shall be low or Hi-Z state when VDD is off. Please refer to specifications of SN75LVDS82DGG (Texas Instruments) in detail.

### 1. Characteristics of each signal are as following:

Symbol	Parameter	Min	Typ	Max	Units	Condition
V <sub>TH</sub>	Differential Input High Threshold	-	-	+100	[mV]	V <sub>ICM</sub> = 1.2V <b>Note 1</b>
V <sub>TL</sub>	Differential Input Low Threshold	-100	-	-	[mV]	V <sub>ICM</sub> = 1.2V <b>Note 1</b>
V <sub>ID</sub>	Input Differential Voltage	100	-	600	[mV]	<b>Note 1</b>
V <sub>ICM</sub>	Differential Input Common Mode Voltage	+1.0	+1.2	+1.5	[V]	V <sub>TH</sub> -V <sub>TL</sub> = 200mV (max) <b>Note 1</b>

#### Note 1: LVDS Signal Waveform

##### Single-End

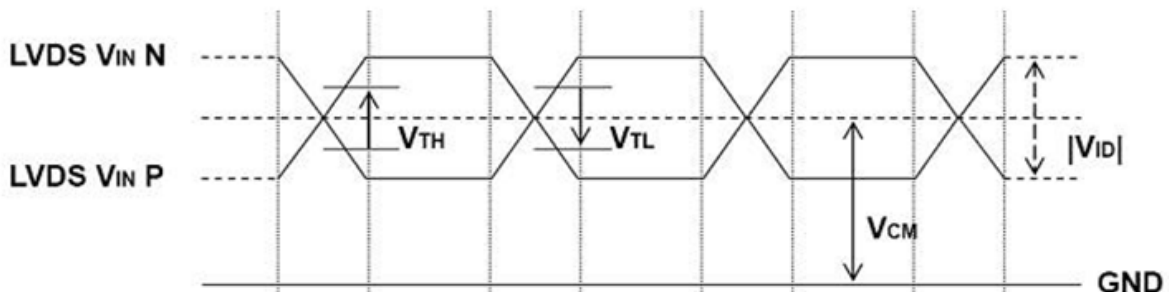

##### Differential Signal

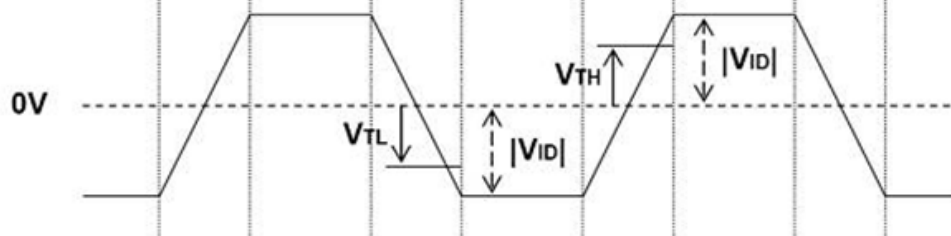

## 2. AC Characteristics

Description	Symbol	Min	Max	Unit	Note
Maximum deviation of input clock frequency during SSC	$F_{DEV}$	-	TBD	%	
Maximum modulation frequency of input clock during SSC	$F_{MOD}$	-	TBD	KHz	

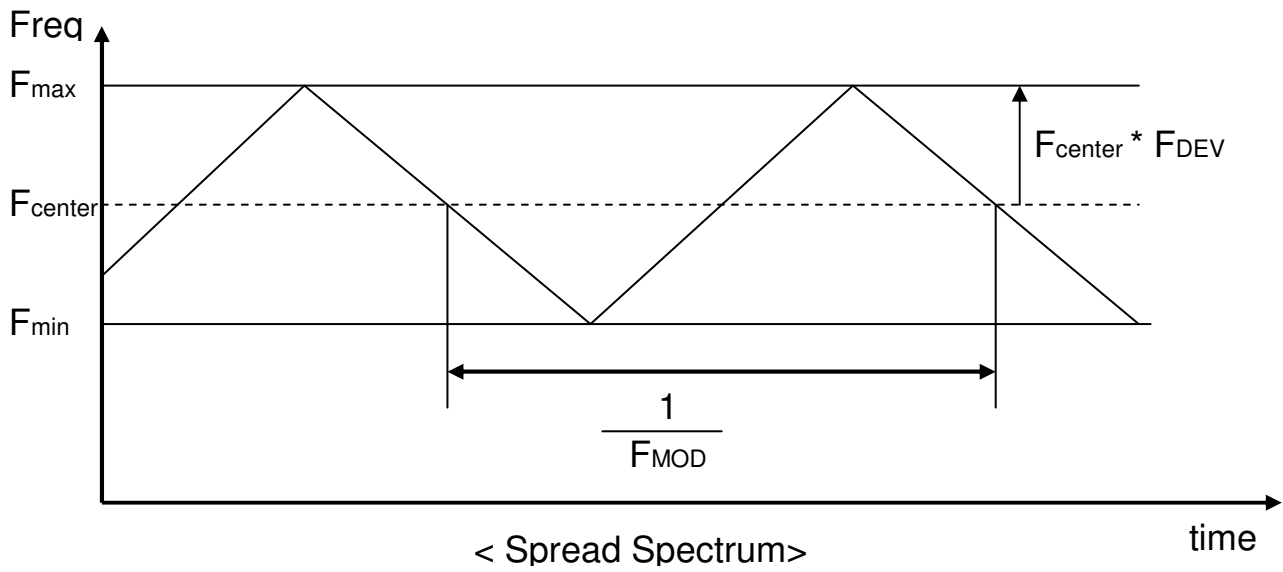

## 5.2 Backlight Unit

Parameter guideline for LED driving is under stable conditions at 25°C (Room Temperature):

Symbol	Parameter	Min.	Typ.	Max.	Unit	Note
$I_{R_{LED}}$	LED Operation Current	-	110	TBD	[mA] Note 1	<b>Operating with fixed driving current</b>
$V_{LB}$	Light Bar Operation Voltage (for reference)	45	49.5	54	[Volt] Note 2	
$P_{BLU}$	BLU Power consumption (for reference)	-	21.8	TBD	[Watt]	
$LT_{LED}$	LED life Time (Typical)	25,000	30,000	-	[Hour] Note 3	

Note 1 :The specified current is input LED chip 100% duty current.

Note 2 : The value showed in the table is one light bar's operation voltage.

Note 3 : Based on the operating current is 110mA.

Note 4: Each LED light bar consists of 60 pcs LED package ( 4 strings x 15 pcs / string )

## 6.0 Signal Characteristic

### 6.1 Pixel Format Image

Following figure shows the relationship of the input signals and LCD pixel format.

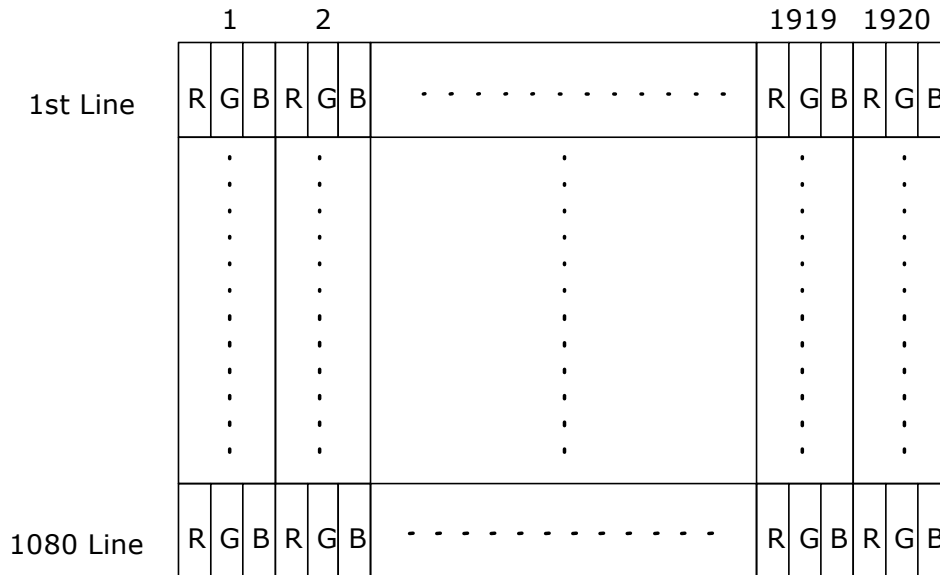

### 6.2 The input data format

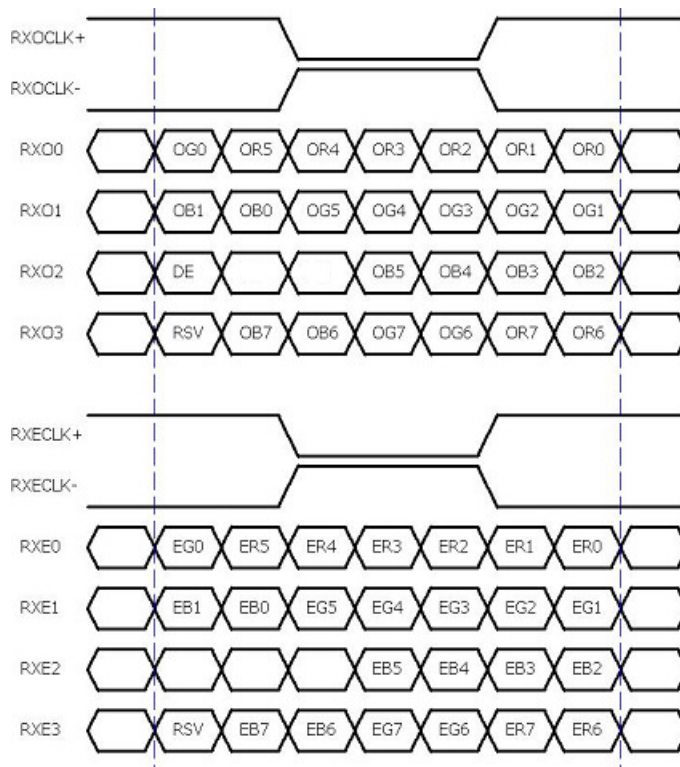

**Note 1:** R/G/B data 7:MSB, R/G/B data 0:LSB    O = "Odd Pixel Data"    E = "Even Pixel Data"



## 6.3 Signal Description

The module using one LVDS receiver SN75LVDS82(Texas Instruments). LVDS is a differential signal technology for LCD interface and high speed data transfer device. LVDS transmitters shall be SN75LVDS83(negative edge sampling). The first LVDS port(RxOxxx) transmits odd pixels while the second LVDS port(RxExxx) transmits even pixels.

PIN #	SIGNAL NAME	DESCRIPTION
1	RxOIN0-	Negative LVDS differential data input (Odd data)
2	RxOIN0+	Positive LVDS differential data input (Odd data)
3	RxOIN1-	Negative LVDS differential data input (Odd data)
4	RxOIN1+	Positive LVDS differential data input (Odd data)
5	RxOIN2-	Negative LVDS differential data input (Odd data, DSPTMG)
6	RxOIN2+	Positive LVDS differential data input (Odd data, DSPTMG)
7	GND	Power Ground
8	RxOCLK-	Negative LVDS differential clock input (Odd clock)
9	RxOCLK+	Positive LVDS differential clock input (Odd clock)
10	RxOIN3-	Negative LVDS differential data input (Odd data)
11	RxOIN3+	Positive LVDS differential data input (Odd data)
12	RxEIN0-	Negative LVDS differential data input (Even data)
13	RxEIN0+	Positive LVDS differential data input (Even data)
14	GND	Power Ground
15	RxEIN1-	Positive LVDS differential data input (Even data)
16	RxEIN1+	Negative LVDS differential data input (Even data)
17	GND	Power Ground
18	RxEIN2-	Negative LVDS differential data input (Even data)
19	RxEIN2+	Positive LVDS differential data input (Even data)
20	RxECLK-	Negative LVDS differential clock input (Even clock)
21	RxECLK+	Positive LVDS differential clock input (Even clock)
22	RxEIN3-	Negative LVDS differential data input (Even data)
23	RxEIN3+	Positive LVDS differential data input (Even data)
24	GND	Power Ground
25	NC	No connection (for AUO test only. Do not connect)
26	NC	No connection (for AUO test only. Do not connect)
27	VDD	Power +5V
28	VDD	Power +5V
29	VDD	Power +5V
30	VDD	Power +5V

**Note1:** Start from left side

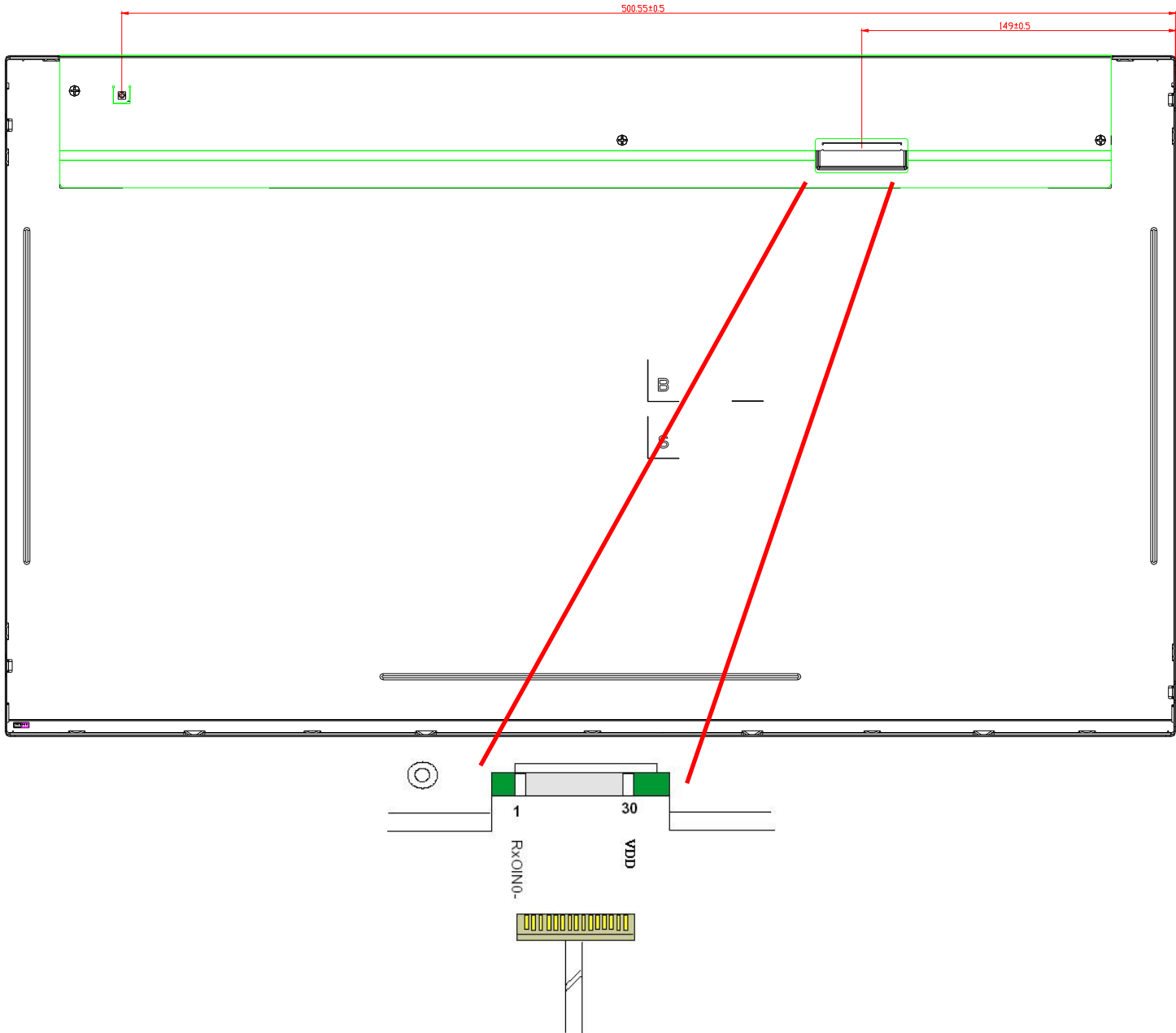

**Note2:** Input signals of odd and even clock shall be the same timing.

## 6.4 Timing Characteristics

Basically, interface timing described here is not actual input timing of LCD module but close to output timing of SN75LVDS82DGG (Texas Instruments) or equivalent.

Item	Symbol	Min	Typ	Max	Unit	
Data CLK	Tclk	40	72	83	[MHz]	
H-section	Period	Th	1034	1060	2047	[Tclk]
	Display Area	Tdisp(h)	960	960	960	[Tclk]
	Blanking	Tblk(h)	74	100	1087	[Tclk]
V-section	Period	Tv	1088	1120	2047	[Th]
	Display Area	Tdisp(v)	1080	1080	1080	[Th]
	Blanking	Tblk(v)	8	40	967	[Th]
Frame Rate	F	50	60	75	[Hz]	

**Note** : DE mode only

## 6.5 Timing diagram

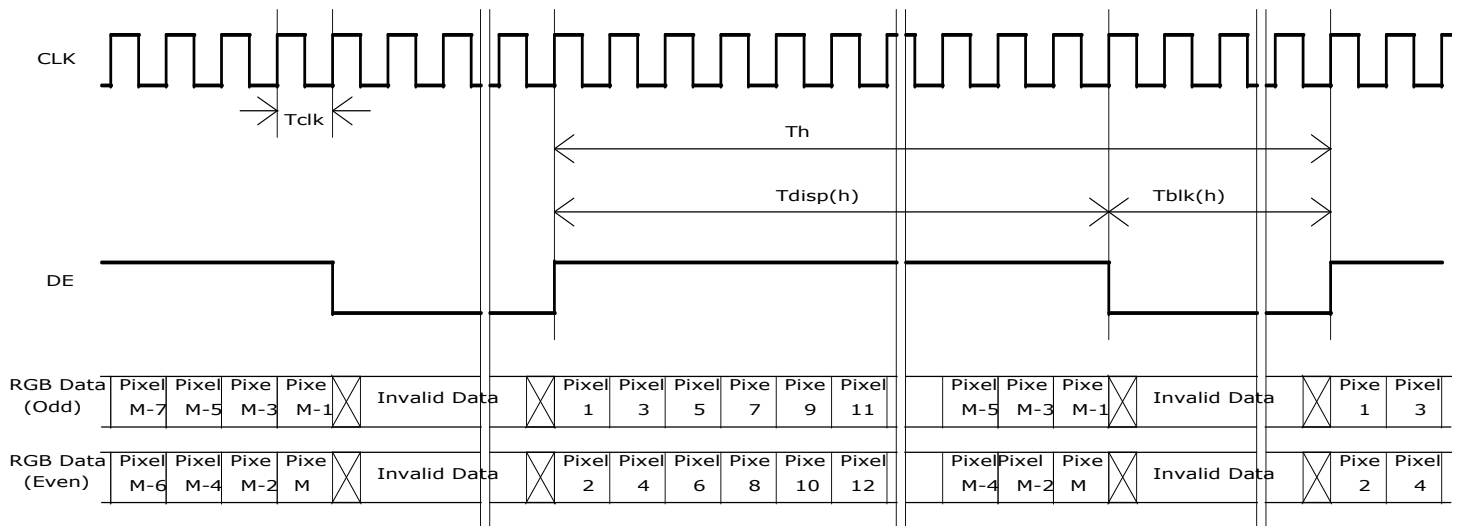
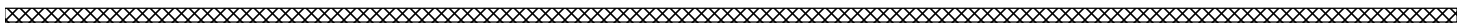
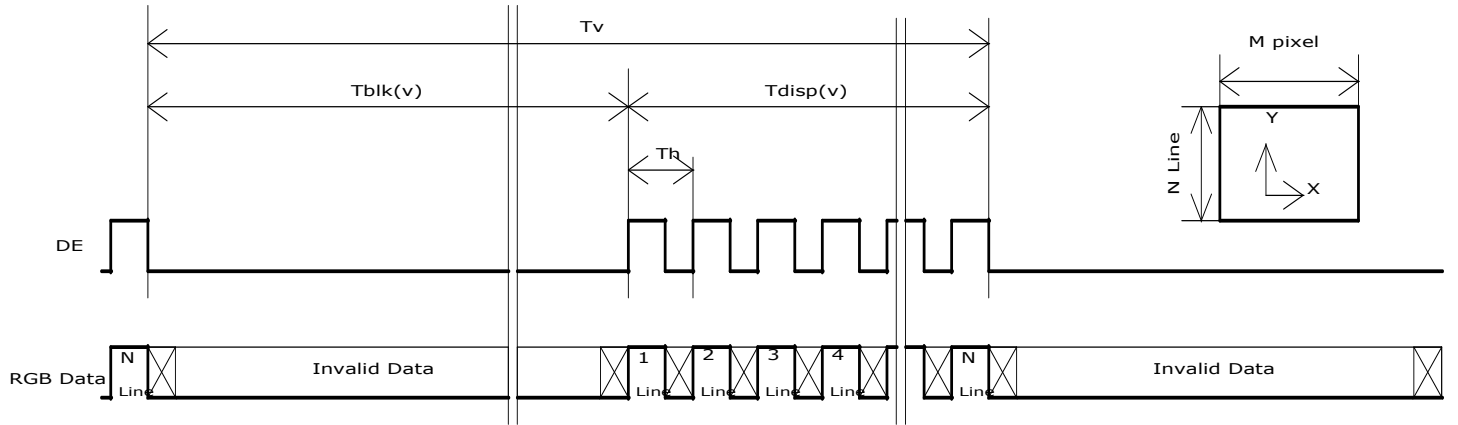

## 6.6 Power ON/OFF Sequence

VDD power and lamp on/off sequence are as follows. Interface signals are also shown in the chart. Signals from any system shall be Hi-Z state or low level when VDD is off.

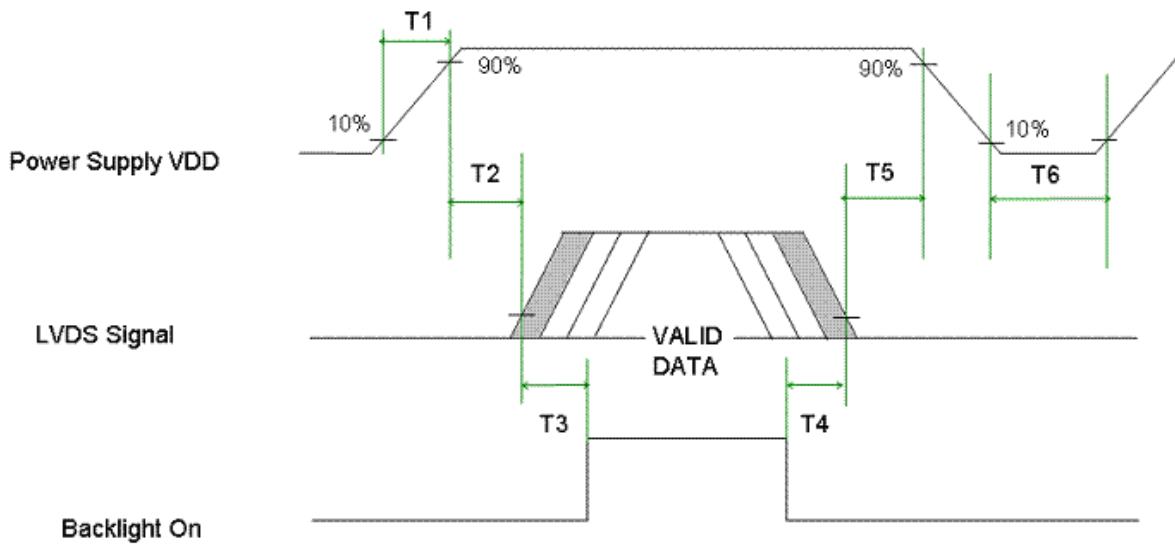

Parameter	Value		Unit
	Min.	Max.	
T1	0.5	10	[msec]
T2	0	50	[msec]
T3	500	-	[msec]
T4	200	-	[msec]
T5	0	50	[msec]
T6	1000	-	[msec]

## 7.0 Connector & Pin Assignment

Physical interface is described as for the connector on module. These connectors are capable of accommodating the following signals and will be following components.

### 7.1 TFT LCD Module

Connector Name / Designation	Interface Connector / Interface card
Manufacturer	JAE STARCONN
Type Part Number	FI-XB30SRL-HF11 093F30-B0T01A
Mating Housing Part Number	FI-X30HL (Locked Type)

#### 7.1.1 Pin Assignment

Pin#	Signal Name	Pin#	Signal Name
1	RxOIN0-	2	RxOIN0+
3	RxOIN1-	4	RxOIN1+
5	RxOIN2-	6	RxOIN2+
7	GND	8	RxOCLKIN-
9	RxOCLKIN+	10	RxOIN3-
11	RxOIN3+	12	RxEIN0-
13	RxEIN0+	14	GND
15	RxEIN1-	16	RxEIN1+
17	GND	18	RxEIN2-
19	RxEIN2+	20	RxECLKIN-
21	RxECLKIN+	22	RxEIN3-
23	RxEIN3+	24	GND
25	NC (for AUO test only. Do not connect)	26	NC (for AUO test only. Do not connect)
27	VDD	28	VDD
29	VDD	30	VDD

## 7.2 Connector on Backlight Unit.

This connector is mounted on LED light-bar.

Connector Name / Designation	Light Bar Connector
Manufacturer	CviLux Corporation
Type Part Number	CI1406M1HRB-NH

### 7.2.1 Pin assignment

Pin no.	Signal name
1	IRLED (current out)
2	IRLED (current out)
3	VLED (voltage in)
4	VLED (voltage in)
5	IRLED (current out)
6	IRLED (current out)

## 8.0 Reliability Test

Environment test conditions are listed as following table.

Items	Required Condition	Note
Temperature Humidity Bias (THB)	Ta= 50°C, 80%RH, 300hours	
High Temperature Operation (HTO)	Ta= 50°C, 50%RH, 300hours	
Low Temperature Operation (LTO)	Ta= 0°C, 300hours	
High Temperature Storage (HTS)	Ta= 60°C, 300hours	
Low Temperature Storage (LTS)	Ta= -20°C, 300hours	
Vibration Test (Non-operation)	Acceleration: 1.5 Grms Wave: Random Frequency: 10 - 200 Hz Duration: 30 Minutes each Axis (X, Y, Z)	
Shock Test (Non-operation)	Acceleration: 50 G Wave: Half-sine Active Time: 20 ms Direction: ±X, ±Y, ±Z (one time for each Axis)	
Drop Test	Height: 46 cm, package test	
Thermal Shock Test (TST)	-20°C/30min, 60°C/30min, 100 cycles	<b>1</b>
On/Off Test	On/10sec, Off/10sec, 30,000 cycles	
ESD (Electro Static Discharge)	Contact Discharge: ± 8KV, 150pF(330Ω ) 1sec, 15 points, 25 times/ point.	<b>2</b>
	Air Discharge: ± 15KV, 150pF(330Ω ) 1sec 15 points, 25 times/ point.	
Altitude Test	Operation:10,000 ft Non-Operation:30,000 ft	

**Note 1:** The TFT-LCD module will not sustain damage after being subjected to 100 cycles of rapid temperature change. A cycle of rapid temperature change consists of varying the temperature from -20°C to 60°C, and back again. Power is not applied during the test. After temperature cycling, the unit is placed in normal room ambient for at least 4 hours before power on.

**Note 2:** EN61000-4-2, ESD class B: Certain performance degradation allowed  
No data lost  
Self-recoverable  
No hardware failures.



## 9.0 Shipping Label

The label is on the panel as shown below:

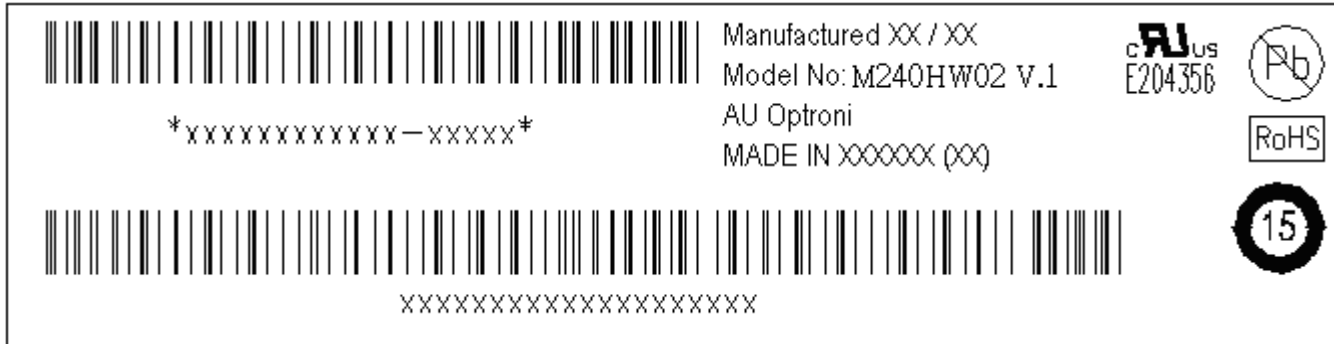

**Note 1:** For Pb Free products, AUO will add  for identification.

**Note 2:** For RoHS compatible products, AUO will add  for identification.

**Note 3:** For China RoHS compatible products, AUO will add  for identification.

**Note 4:** The Green Mark will be presented only when the green documents have been ready by AUO Internal Green Team.

## 10.0 Mechanical Characteristics

- NOTES :
1. THE DIMENSION EXCLUDES DEFORMATION.
  2. TOLERANCE WITHOUT NOTICED TO BE  $\pm 0.5MM$ .
  3. SUGGEST FOR CUSTOMER SCREW SELECTION:  
CUSTOMER ASSEMBLY TOLERANCE + CUSTOMER CHASSIS THICKNESS
  4. TORQUE OF M3 USER HOLE SHOULD BE WITHIN 4 kgf-cm  
AND JUST RESCREW 10 TIMES

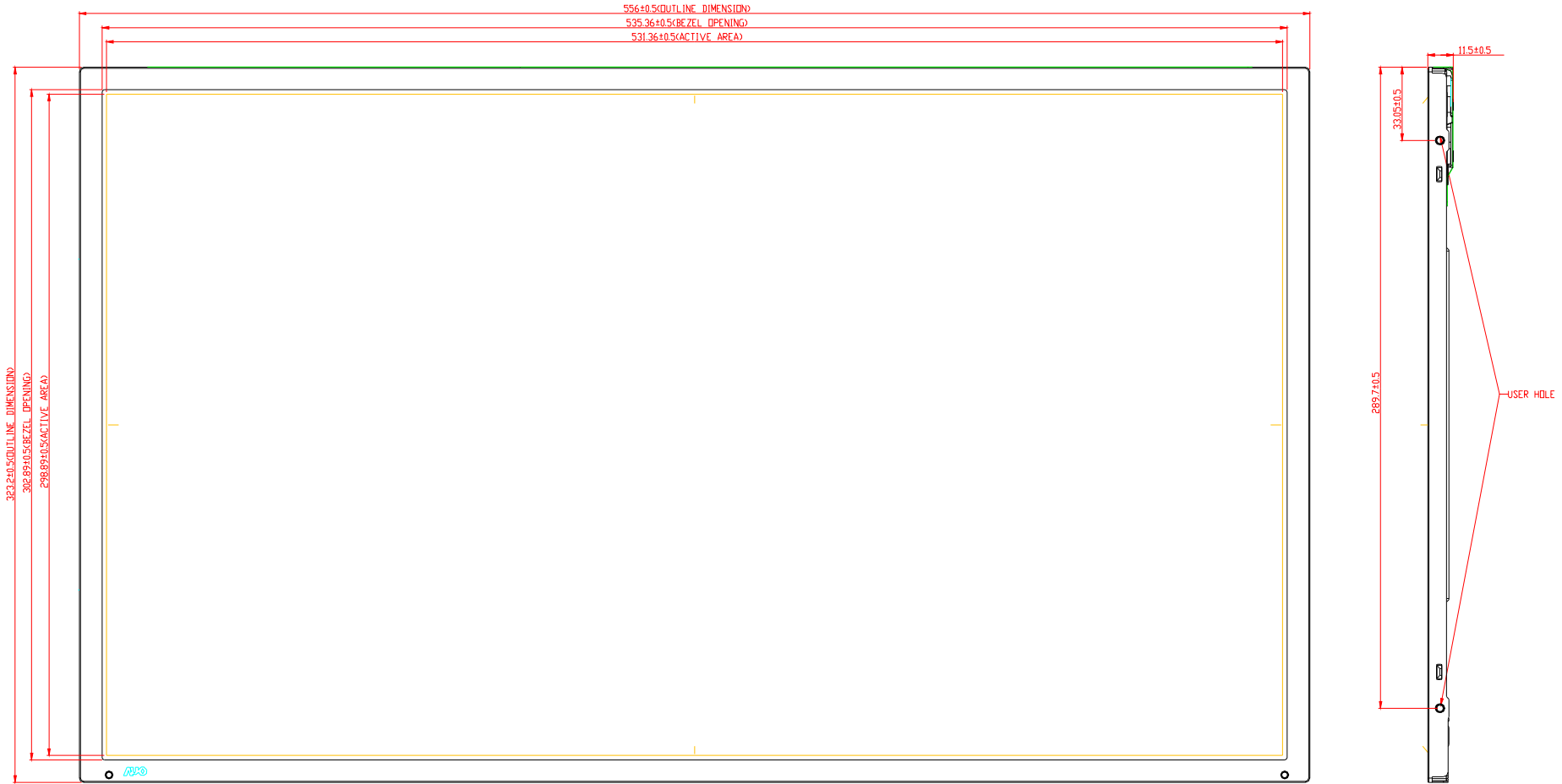



# Product Specification

AU OPTRONICS CORPORATION

M240HW02 V1

