

PROPRIETARY NOTE

THIS SPECIFICATION IS THE PROPERTY OF BOE HF AND SHALL NOT BE REPRODUCED OR COPIED WITHOUT THE WRITTEN PERMISSION OF BOE HF AND MUST BE RETURNED TO BOE HF UPON ITS REQUEST



SPEC. NUMBER S8-*	PRODUCT GROUP TFT- LCD	REV. P0	ISSUE DATE 2018-4-3	PAGE 1 OF 25
----------------------	---------------------------	------------	------------------------	-----------------

BA121S01-200 Product Specification

BUYER	
SUPPLIER	HEFEI BOE Optoelectronics Technology CO., LTD
FG-Code	BA121S01-200

ITEM	BUYER SIGNATURE	DATE
_____	_____	_____
_____	_____	_____
_____	_____	_____

ITEM	SUPPLIER SIGNATURE	DATE
Prepared	_____	_____
Reviewed	_____	_____
Approved	_____	_____

HEFEI BOE OPTOELECTRONICS TECHNOLOGY

PRODUCT GROUP	REV	ISSUE DATE	
TFT- LCD PRODUCT	P0		

SPEC. NUMBER S8-*	SPEC . TITLE BA121S01-200 Product Specification	PAGE 2 OF 25
----------------------	--	-----------------

REVISION HISTORY

REV.	ECN No.	DESCRIPTION OF CHANGES	DATE	PREPARED
P0		Initial Release	2018-4-3	

PRODUCT GROUP		REV	ISSUE DATE	BOE
TFT- LCD PRODUCT		P0		
SPEC. NUMBER S8-*	SPEC. TITLE BA121S01-200 Product Specification			PAGE 3 OF 25

Contents

No.	Items	Page
1.0	General Description	
2.0	Absolute Maximum Ratings	
3.0	Electrical Specifications	
4.0	Optical Specifications	
5.0	Reliability Test	
6.0	Packing Information	
7.0	Product Label	
8.0	Handling & Cautions	
9.0	Appendix	

PRODUCT GROUP		REV	ISSUE DATE	BOE
TFT- LCD PRODUCT		P0		
SPEC. NUMBER	SPEC. TITLE		PAGE	
S8-*	BA121S01-200 Product Specification		4 OF 25	

1.0 GENERAL DESCRIPTION

1.1 Introduction

BA121S01-200 is a color active matrix TFT LCD module using amorphous silicon TFT 's (Thin Film Transistors) as an active switching devices. This module has a 12.1 inch diagonally measured active area with SVGA resolutions (800 horizontal by 600 vertical pixel array). Each pixel is divided into RED, GREEN, BLUE dots which are arranged in vertical stripe and this module can display 16.7M colors.

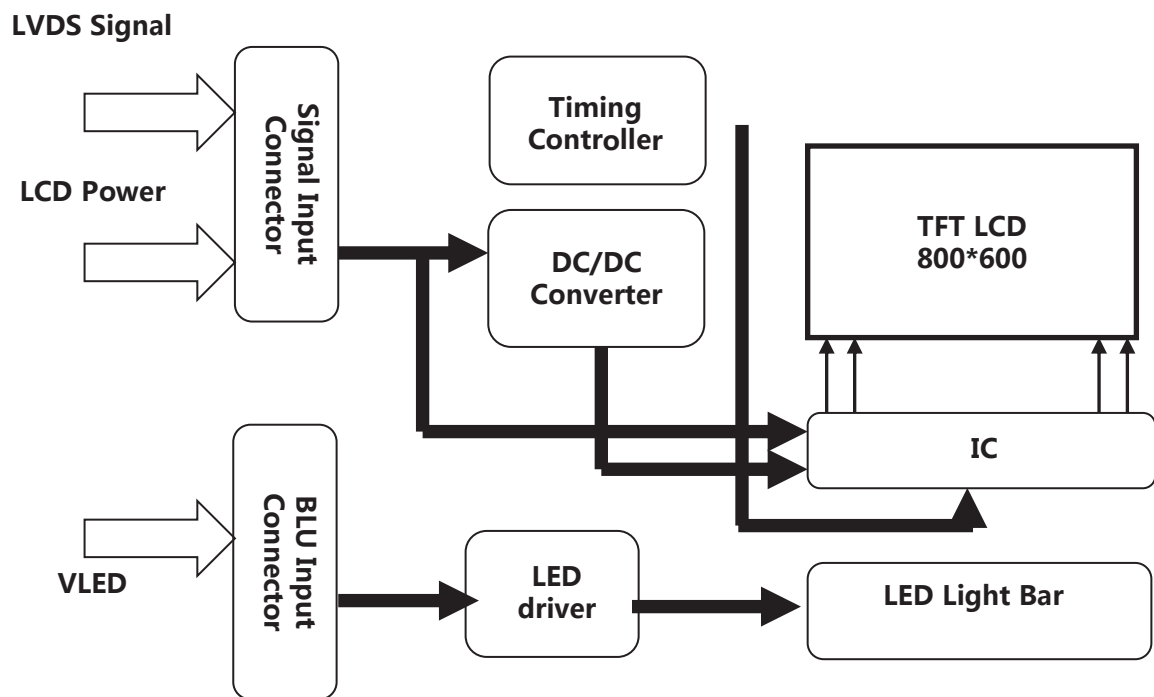

1.2 Features

- 0.5T Glass (Single) ;
- Module Design
- 6/ 8bits LVDS data input selection
- Thin and light weight
- High luminance and contrast ratio, low reflection and wide viewing angle
- RoHS compliant

PRODUCT GROUP		REV	ISSUE DATE	
TFT- LCD PRODUCT		P0		
SPEC. NUMBER S8-*	SPEC. TITLE BA121S01-200 Product Specification			PAGE 5 OF 25

1.3 Application

- Medical Monitor

1.4 General Specification

The followings are general specifications

<Table 1. LCD Module Specifications>

Parameter	Specification	Unit	Remarks
Active Area	246(H)*184.5(V)	mm	
Number Of Pixels	800(H)×600(V)	pixels	
Pixel Pitch	0.1025(H)×RGB×0.3075(V)	mm	
Pixel Arrangement	Pixels RGB stripe arrangement		
Display Mode	Normally White		
Display Colors	262K/16.7M	colors	
Display Mode	Transmissive mode		
Surface Treatment	AG25 (CF) , Clear (TFT)		
Contrast Ratio	800:1(typ.)		
Viewing Angle(CR>10)	80/80/65/75(typ.)	deg.	
Response Time		ms	
Color Gamut	55%		
Brightness	320(min)/400(typ)	cd/m2	
Brightness Uniformity	9 point: min 75% 9 point: typ 80%		
Power Consumption	TBD	watt	
Outline Dimension	279(H)*209(V)*9.0(typ)	mm	
Weight	500(max.)	gram	

PRODUCT GROUP		REV	ISSUE DATE	BOE
TFT- LCD PRODUCT		P0		
SPEC. NUMBER	SPEC. TITLE		PAGE	
S8-*	BA121S01-200 Product Specification		6 OF 25	

2.0 ABSOLUTE MAXIMUM RATINGS

The followings are maximum values which, if exceed, may cause faulty operation or damage to the unit. The operational and non-operational maximum voltage and current values are listed in Table 2.

< Table 3. Absolute Maximum Ratings >

Parameter		Symbol	Min.	Max.	Unit	Remarks
Power Supply	LCD Module	VDD	VSS-0.3	3.9	V	Ta = 25 °C
	BLU	VLED	VSS-0.3	44	V	
Operating Temperature		T _{OP}	-20	+70	°C	Note 1
Storage Temperature		T _{ST}	-30	+80	°C	

Note : 1) Temperature and relative humidity range are shown in the figure below.
Wet bulb temperature should be 39 °C max. and no condensation of water.

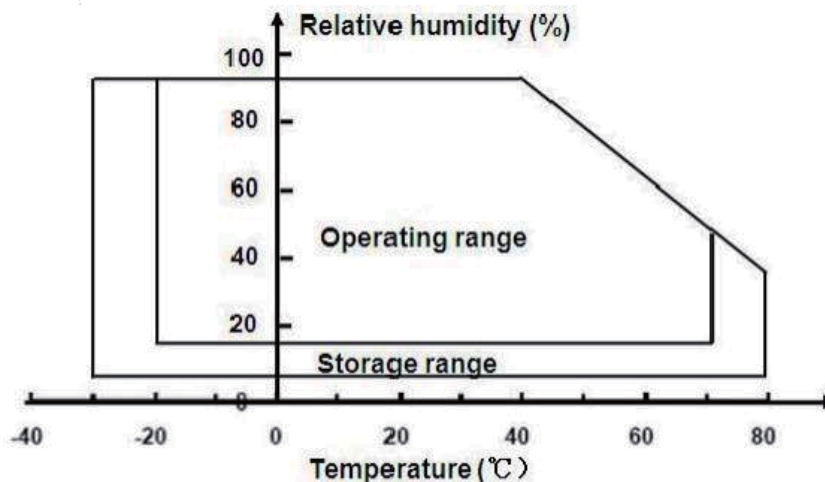

PRODUCT GROUP		REV	ISSUE DATE	BOE
TFT- LCD PRODUCT		P0		
SPEC. NUMBER	SPEC. TITLE			PAGE
S8-*	BA121S01-200 Product Specification			7 OF 25

3.0 ELECTRICAL SPECIFICATIONS

3.1 TFT LCD Module

< Table 4. LCD Module Electrical specifications > [Ta=25±2 °C]

Parameter	Symbol	Values				Notes	
		Min.	Typ.				
Power Supply Voltage	VDD	3.0	3.3		V		
	VRP				mV	Ripple	
Power Supply Current	IDD	-	-	-	mA	Note 1	
	IBAT		160	180	mA		
Power Consumption	PLCD	-	0.40	0.45	W		
Rush current	IRUSH	-		3.0	A	Note 2	
CMOS Interface	Input Voltage	VIH	2.7		3.3	V	
		VIL	0		0.5	V	
	Output Voltage	VOH	2.7		3.3	V	
		VOL	0		0.5	V	

Notes : 1. The supply voltage is measured and specified at the interface connector of LCM.
The current draw and power consumption specified is for VBAT=3.8V, Frame rate $f_v=60\text{Hz}$ and Clock frequency = 156.8MHz. Test Pattern of power supply current

a) Typ : Mosaic 8 x 6 Pattern(L0/L255)

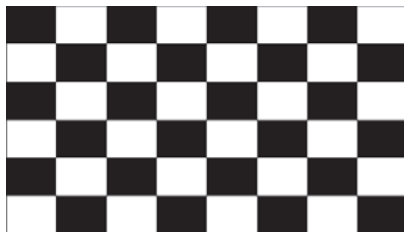

b) Max : skip 1H1V dot(L0/L255)



2. The duration of rush current is about 2ms and rising time of Power Input is 1ms(min)

PRODUCT GROUP		REV	ISSUE DATE	
TFT- LCD PRODUCT		P0		
SPEC. NUMBER	SPEC. TITLE		PAGE	
S8-*	BA121S01-200 Product Specification		8 OF 25	

3.2 Back-Light Unit

Table 5. LED Driver Electrical Specifications >

[Ta = 25 ± 2 °C]

Parameter	Symbol	Values			Unit	Notes	
		Min.	Typ.	Max.			
LED Supply Voltage	VLED	11.5	12	12.5	V	Note 1	
	VRP			-	mV	Ripple	
LED Forward Current	ILED	-	-	-	mA		
Power Consumption	PLED	-	-	-	W		
Rush current	IRUSH	-	-	3.0	A		
BLU on/off Level	BLU on	3.0	3.3	3.6	V		
	BLU off		-	0.5	V		
PWMIN	Level	High Level	3.0	3.3	3.6	V	
		Low Level			0.5	V	
	Frequency	F _{PWM}	120	-	1K	Hz	
		D _{PWM}	1	-	100	%	
LED Quantity	QLED	-	24	-	EA		
LED Life Time	TLED	30000	-	-	Hrs	Note 2	

Notes: 1. PLED = VLED × ILED (Without LED converter transfer efficiency)

2. The life time of LED, 30,000Hrs, is determined as the time at which luminance of the LED is 50% compared to that of initial value at the typical LED current on condition of continuous operating at 25 ± 2°C.

PRODUCT GROUP		REV	ISSUE DATE	BOE
TFT- LCD PRODUCT		P0		
SPEC. NUMBER	SPEC. TITLE		PAGE	
S8-*	BA121S01-200 Product Specification		9 OF 25	

3.4 INPUT TERMINAL PIN ASSIGNMENT

This LCD employs two interface connections, a 20 pin ZIF connector is used for the LCD module electronics interface and a 5 pin ZIF connector is used for the internal backlight system.

3.4.1 Pin assignment for LCD module

Connector : MSB240420-HEA(STM) or equivalent

< Table7. Pin Assignment for LCD Module Connector >

Pin No.	Symbol	Description	I/O
1	VCC	Power supply	P
2	VCC	Power supply	P
3	GND	Ground	-
4	SEL	VCC:8Bits; GND/NC:6Bits	I
5	RIN0-	LVDS signal input	I
6	RIN0+	LVDS signal input	I
7	GND	Ground	-
8	RIN1-	LVDS signal input	I
9	RIN1+	LVDS signal input	I
10	GND	Ground	-
11	RIN2-	LVDS signal input	I
12	RIN2+	LVDS signal input	I
13	GND	Ground	-
14	CLKIN-	LVDS clock input	I
15	CLKIN+	LVDS clock input	I
16	GND	Ground	-
17	RIN3-	LVDS signal input	I
18	RIN3+	LVDS signal input	I
19	REVERSE	VCC: Display Reverse; GND/NC: Normal Display	I
20	NC/GND	Test function	-

PRODUCT GROUP		REV	ISSUE DATE	BOE
TFT- LCD PRODUCT		P0		
SPEC. NUMBER S8-*	SPEC. TITLE BA121S01-200 Product Specification			PAGE 10 OF 25

3.4.2 Pin assignment for LED Bar

Connector : MSB24038P5 (STM) or equivalent

< Table8. Pin assignment for LED Bar >

Pin No	Symbol	Description	Remarks
1	NC	No connection	
2	PWM	Luminance control	
3	EN	3.3V-on / 0V-off	
4	GND	Ground	
5	VLED	Power supply	12V

3.7 Power Sequence

[Ta =25±2 °C]

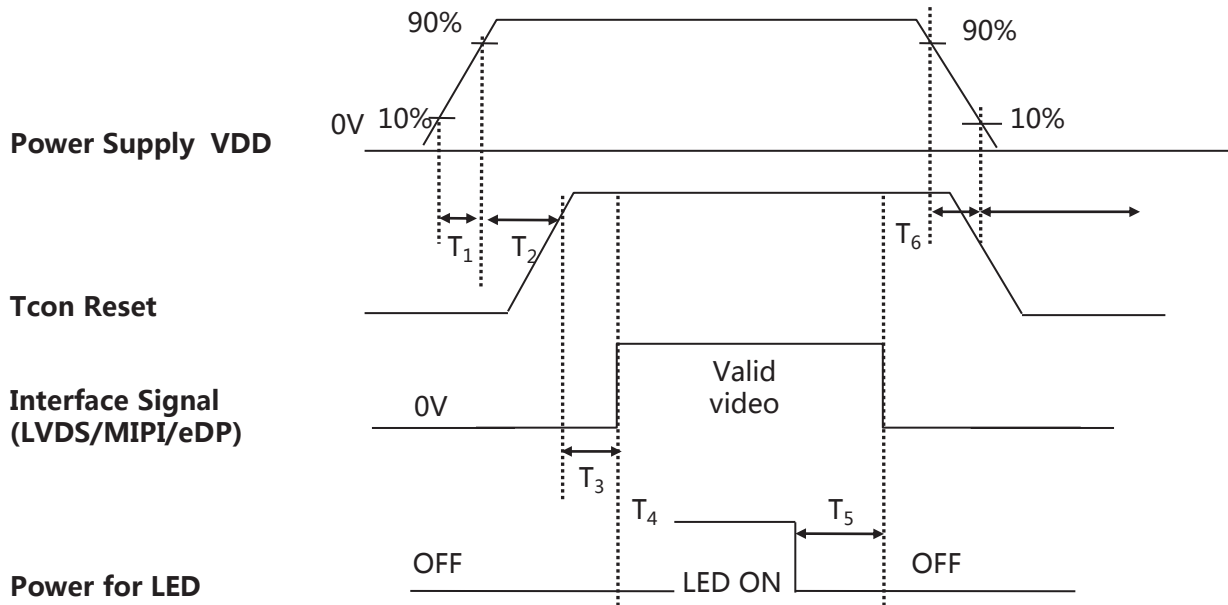

< Table15. Sequence Table >

Parameter	Value			Units
		Typ.	Max.	
T1	0.1	-	5	(ms)
T2	10	-	30	(ms)
T3	5	-	100	(ms)
T4	200	-	-	(ms)
T5	200	-	-	(ms)
T6	0	-	50	(ms)
T7	0	-	10	(ms)
T8	500	-	-	(ms)

PRODUCT GROUP		REV	ISSUE DATE	BOE
TFT- LCD PRODUCT		P0		
SPEC. NUMBER	SPEC. TITLE		PAGE	
S8-*	BA121S01-200 Product Specification		12 OF 25	

4.0 OPTICAL SPECIFICATIONS

4.1 Overview

The test of optical specifications shall be measured in a dark room (ambient luminance ≤ 1 lux and temperature = $25\pm 2^\circ\text{C}$) with the equipment of Luminance meter system (Gonio meter system and TOPCON BM-5) and test unit shall be located at an approximate distance 50cm from the LCD surface at a viewing angle of θ and Φ equal to 0° . We refer to $\theta=0$ ($=\theta_3$) as the 3 o' clock direction (the "right"), $\theta=90$ ($=\theta_{12}$) as the 12 O' clock direction ("upward"), $\theta=180$ ($=\theta_9$) as the 9 O' clock direction ("left") and $\theta=270$ ($=\theta_6$) as the 6 O' clock direction ("bottom"). While scanning θ and/or Φ , the center of the measuring spot on the Display surface shall stay fixed.

4.2 Optical Specifications < Table16. Optical Table >

Item	Symbol	Condition	Min	Typ.	Max	Unit	Note
luminance	Bp	$\theta=0^\circ$	320	400	--	cd/m ²	<u>Note 1</u>
Brightness Uniformity	ΔB_p		75	80	--	%	<u>Note 2</u>
Viewing Angle	θ_L	Cr ≥ 10	70	80	--	deg	<u>Note 3</u>
	θ_R		70	80	--		
	ψ_T		55	65	--		
	ψ_B		65	75	--		
Contrast Ratio	Cr	$\theta=0^\circ$	600	800		-	<u>Note 4</u>
Response Time	Tr+Tf	FF=0°	-	30	35	ms	<u>Note 5</u>
Color Coordinate of CIE1931	Rx	$\theta=0^\circ$	0.578	0.608	0.638	-	<u>Note 6</u>
	Ry		0.304	0.334	0.364		
	Gx		0.305	0.335	0.365		
	Gy		0.541	0.571	0.601		
	Bx		0.112	0.152	0.182		
	By		0.066	0.096	0.126		
	Wx		0.263	0.313	0.363		
	Wy		0.279	0.329	0.379		
NTSC Ratio	NTSC	CIE1931	50	55	--	%	<u>Note 7</u>
Polarization Direction of Front Polarizer	PdF			45°		deg	<u>Note 8</u>
Polarization Direction of Rear Polarizer	PdR			45°		Deg	
Gray inversion angle				6点钟			<u>Note 9</u>

PRODUCT GROUP		REV	ISSUE DATE	BOE
TFT- LCD PRODUCT		P0		
SPEC. NUMBER	SPEC. TITLE		PAGE	
S8-*	BA121S01-200 Product Specification		13 OF 25	

Note1:Luminance measurement

The test condition is at ILED=20mA and measured on the surface of LCD module at 25°C.

- The data are measured after LEDs are lighted on for more than 5 minutes and LCM displays are fully white. The brightness is the average value of 9 measured spots. Measurement equipment CS2000 or similar equipments(Field of view:1deg,Distance:50cm)
- Measuring surroundings: Dark room.
- Measuring temperature: Ta=25°C.
- Adjust operating voltage to get optimum contrast at the center of the display.
- Measured value at the center point of LCD panel must be after more than 5 minutes while backlight turning on.

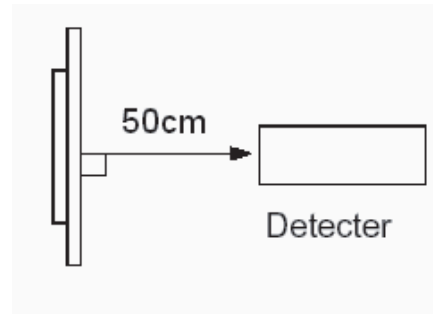
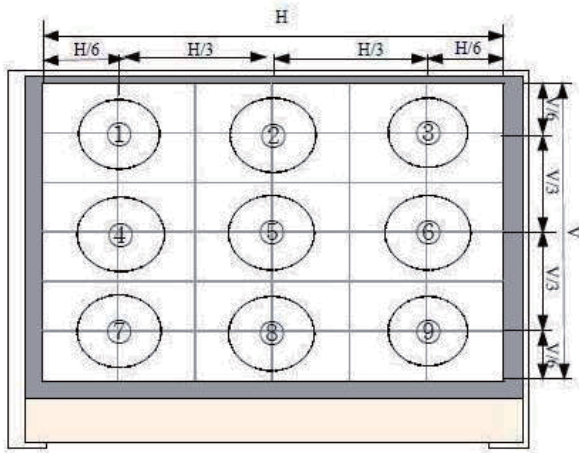

Note2:Uniformity

- The test condition is at ILED=20mA and measured on the surface of LCD module at 25°C.
- Measurement equipment:CS2000 or similar equipments
- The luminance uniformity is calculated by using following formula:
- $\Delta Bp = Bp (\text{Min.}) / Bp (\text{Max.}) \times 100 (\%)$
- Bp (Max.) = Maximum brightness in 13 measured spots
- Bp (Min.) = Minimum brightness in 13 measured spots.

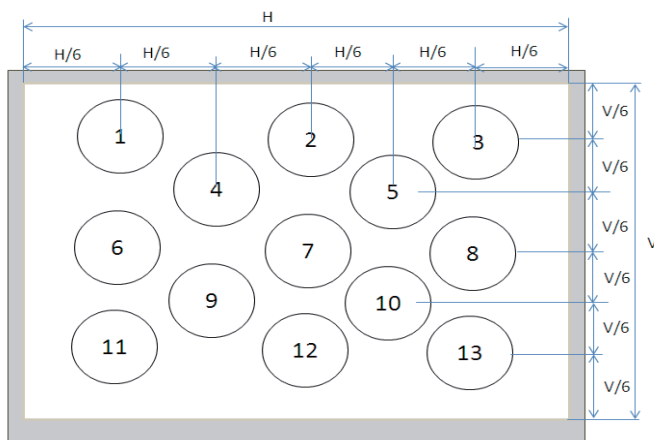

PRODUCT GROUP		REV	ISSUE DATE	BOE
TFT- LCD PRODUCT		P0		
SPEC. NUMBER	SPEC. TITLE		PAGE	
S8-*	BA121S01-200 Product Specification		14 OF 25	

Note 3: The definition of Viewing Angle
Refer to the graph below marked by θ and ϕ .

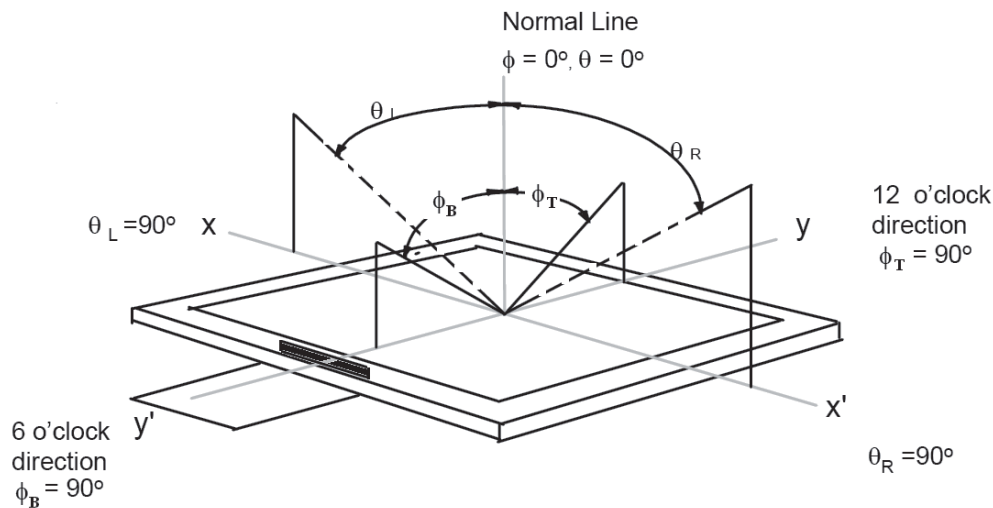

Note 4: The definition of Contrast Ratio (Test LCM using CS2000 or similar equipments):

$$\text{Contrast Ratio (CR)} = \frac{\text{Luminance When LCD is at "White" state}}{\text{Luminance When LCD is at "Black" state}}$$

(Contrast Ratio is measured in optimum common electrode voltage)

Note 5: Definition of Response time. (Test LCD using DMS501 or similar equipments):

The output sign also photo detector are measured when the input sign also are changed from "black" to "white" (Voltage falling time) and from "white" to "black" (Voltage rising time), respectively. The response time is defined as the time interval between the 10% and 90% of amplitudes. Refer to figures below.

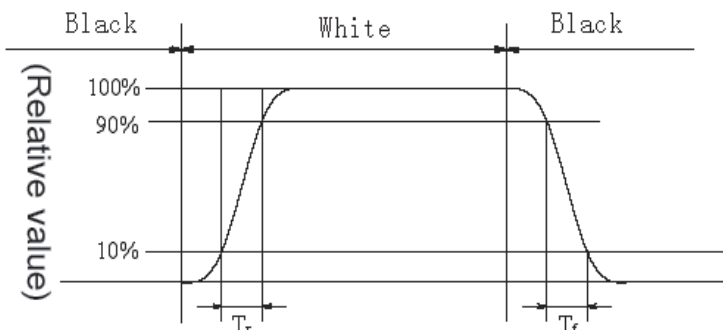

	L0	L1	L2	L3	L4	L5	L6	L7
L0								
L1								
L2								
L3								
L4								
L5								
L6								
L7								

Response time of gray to gray:

Measurement equipment: DMS501 or similar equipments.

Test method: we define 8 grays L0-L7, the grays of L0-L7 were defined as: 0, 36, 73, 109, 146, 182, 219, 255. The output signals of photodetector are measured when the input signals are rechanged from "Lx" to "Ly", x, y = [0, 7]. The response time is defined as the time interval between the 10% and 90% of amplitudes. The result of the test can be noted as below:

PRODUCT GROUP		REV	ISSUE DATE	BOE
TFT- LCD PRODUCT		P0		
SPEC. NUMBER	SPEC. TITLE		PAGE	
S8-*	BA121S01-200 Product Specification		15 OF 25	

Note 6: Color Coordinates of CIE 1931

The test condition is at ILED=20mA and measured on the surface of LCD module at 25°C.
 Measurement equipment:CS2000 or similar equipments
 The Color Coordinate (CIE 1931) is the measurement of the center of the display shown in below figure.

Note 7: Definition of Color of CIE Coordinate and NTSC Ratio.

$$S = \frac{\text{area of RGB triangle}}{\text{area of NTSC triangle}} \times 100\%$$

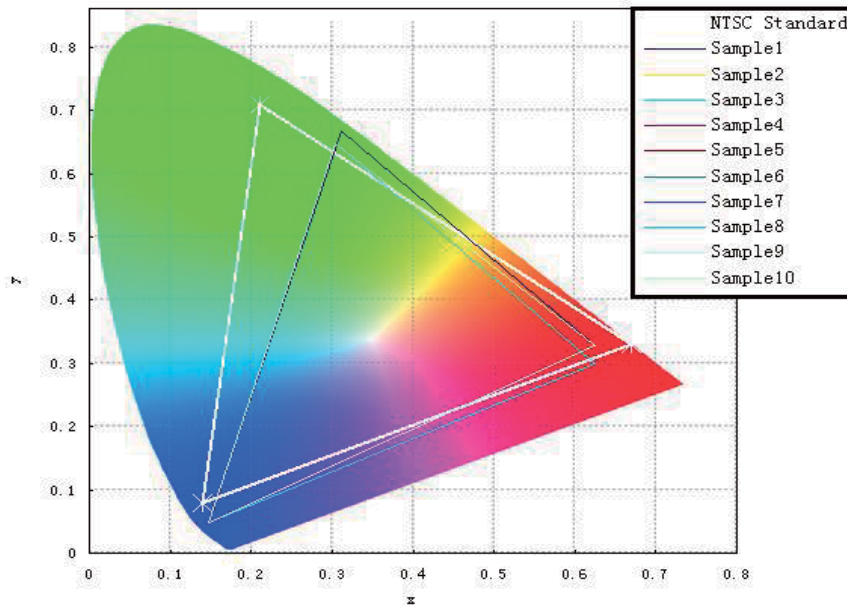

Note 8: Polarization Direction Definition

- Viewing direction is normal user viewing direction which is vertical to the display surface
- The polarizer which is closer to viewer is defined as Front Polarizer
- The polarizer which is on the rear side of viewer is defined as Rear Polarizer
- The X axis is defined as parallel line to top & bottom sidelines of the Active Area
- PdF which is marked in blue arrow is polarization degree of Front polarizer
- PdR which is marked in red arrow is polarization degree of Back polarizer
- The polarization degree parameter must be indicated in range of 0deg to 180deg according to above definition

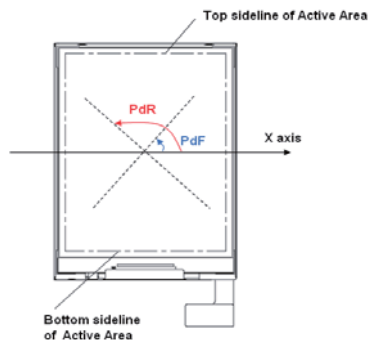

PRODUCT GROUP		REV	ISSUE DATE	BOE
TFT- LCD PRODUCT		P0		
SPEC. NUMBER	SPEC. TITLE		PAGE	
S8-*	BA121S01-200 Product Specification		16 OF 25	

Note 9: Definition of gray inversion angle

- Refer to the graph of note 9.
- Using luminance test method.
- Test pattern : 128 gray
- If the viewing direction is 12 o' clock ,then test the luminance while $\theta = -60^\circ, \theta = -50^\circ, \theta = -40^\circ, \theta = -30^\circ, \theta = -20^\circ, \theta = -10^\circ, \theta = 0^\circ, \theta = 10^\circ, \theta = 20^\circ, \theta = 30^\circ, \theta = 40^\circ, \theta = -50^\circ, \theta = 60^\circ$. The luminance test as figure below:

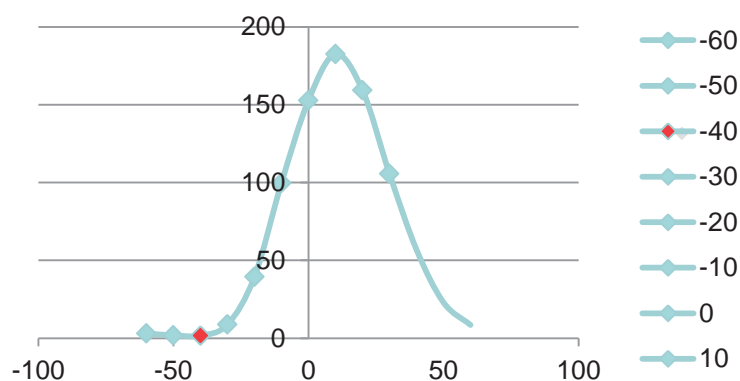

PRODUCT GROUP		REV	ISSUE DATE	
TFT- LCD PRODUCT		P0		
SPEC. NUMBER S8-*	SPEC. TITLE BA121S01-200 Product Specification			PAGE 17 OF 25

5.0 RELIABILITY TEST

The Reliability test items and its conditions are shown in below.

<Table 17. Reliability Test Parameters >

No	Test Items	Conditions
1	High temperature storage test	80°C , 240hr
2	Low temperature storage test	-30°C , 240hr
3	High temperature & high humidity (operation test)	60°C , 90%RH , 240hr
4	Low temperature operation test	-20°C , 240hr
5	High temperature operation test	70°C , 240hr
6	Thermal Shock Test	-40°C~85°C , 1hr/cycle , 96cycle
7		150pF , 330Ω , ±6kV(Contact) , ±8kV (Air)
8	Packing VIB	1.47G , 1-200hz , X , Y , ±Z , 30min/Axis

PRODUCT GROUP		REV	ISSUE DATE	BOE
TFT- LCD PRODUCT		P0		
SPEC. NUMBER	SPEC. TITLE		PAGE	
S8-*	BA121S01-200 Product Specification		18 OF 25	

6.0 PACKING INFORMATION(产品形态 :)

Packing procedure:

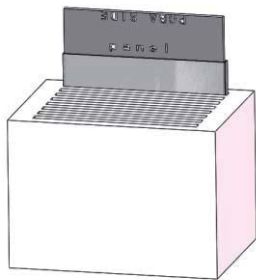

- Put 1pcs Panel into PE Bag
- Crimp PE Bag opening
- Insert 1pcs panel horizontally into the slot
- 8pcs Panel /EPE Box

- Put 1pcs EPE cover upon EPE box
- Put EPE Box & EPE cover into Inner Box
- 8pcs Panel /Inner Box

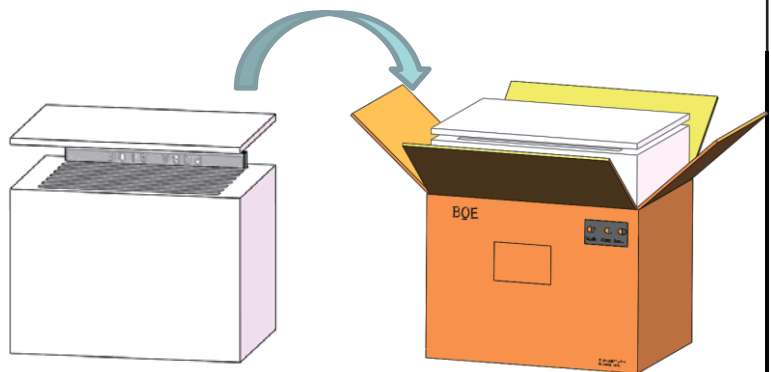

- 3 layers/ Pallet
- 8 boxes/ Layer
- 192pcs Panel / Pallet

6.1 Packing Note(产品形态 : LCM)

- Box Dimension: 375mm(W) x 280mm(D) x 290mm(H)
- Package Quantity in one Box: 8pcs

PRODUCT GROUP		REV	ISSUE DATE	BOE
TFT- LCD PRODUCT		P0		
SPEC. NUMBER	SPEC. TITLE		PAGE	
S8-*	BA121S01-200 Product Specification		19 OF 25	

6.2 Box label (产品形态 :)

- Label Size :115mm*55mm
- Contents
 - Model : LCM
 - Q`ty : 8pcs/Box
 - Serial No. : Box Serial No. as shown below.
 - Date : Packing Date
 - FG Code : FG Code of Product

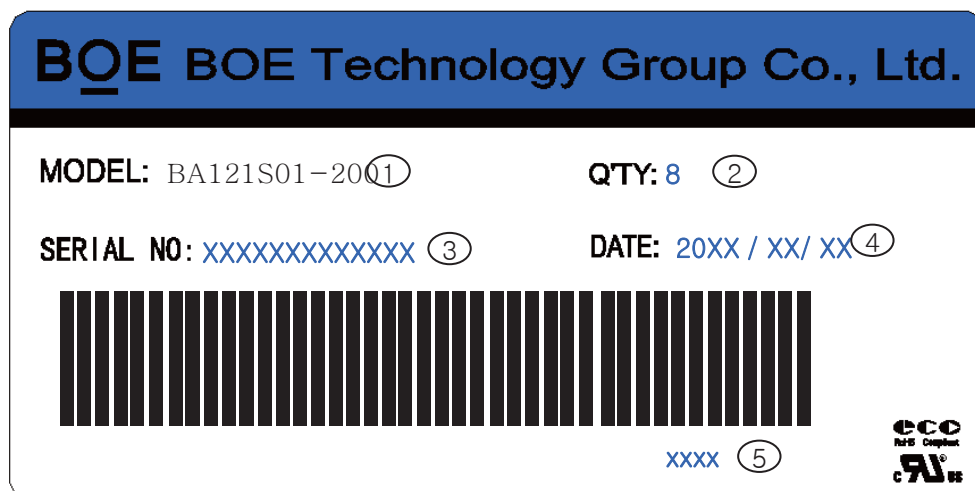

No.	1	2	3	4	5	6	7	8	9	10	11	12	13
Code	X	X	S	3	1	8	B	0	0	0	1	H	D
	GBN		Grade	B3	Year		Month	Rev	Serial number				

PRODUCT GROUP		REV	ISSUE DATE	
TFT- LCD PRODUCT		P0		
SPEC. NUMBER	SPEC. TITLE		PAGE	
S8-*	BA121S01-200 Product Specification		20 OF 25	

7.0 Product Label

Label Size: 48mmx12mmx0.08mm,
44-9231007

1. FG-CODE First 12 digits : ET121S0M-N11
2. MDL ID bar code
3. MDL ID
4. Customer P/N

BOE MDL ID rule

No.	1	2	3	4	5	7	8	9	10	11	12	13	14	15	16	17
Code	X	X	S	3	8	2	D	8	5	0	0	0	0	0	2	1
	GBN		Grade	B3	Year	Day	FG Code last four digits				Serial number					

PRODUCT GROUP		REV	ISSUE DATE	
TFT- LCD PRODUCT		P0		
SPEC. NUMBER	SPEC. TITLE		PAGE	
S8-*	BA121S01-200 Product Specification		21 OF 25	

8.0 Handling & Cautions

8.1 Mounting Method

- The panel of the LCD consists of two thin glasses with polarizers which easily get damaged. So extreme care should be taken when handling the LCD.
- Excessive stress or pressure on the glass of the LCD should be avoided. Care must be taken to insure that no torsional or compressive forces are applied to the LCD unit when it is mounted.
- If the customer's set presses the main parts of the LCD, the LCD may show the abnormal display. But this phenomenon does not mean the malfunction of the LCD and should be pressed by the way of mutual agreement.
- To determine the optimum mounting angle, refer to the viewing angle range in the specification for each model.
- Mount a LCD module with the specified mounting parts.

8.2 Caution of LCD Handling and Cleaning

- Since the LCD is made of glass, do not apply strong mechanical impact or static load onto it. Handling with care since shock, vibration, and careless handling may seriously affect the product. If it falls from a high place or receives a strong shock, the glass may be broken.
- The polarizers on the surface of panel are made from organic substances. Be very careful for chemicals not to touch the polarizers or it leads the polarizers to be deteriorated.
- If the use of a chemical is unavoidable, use soft cloth with solvent (recommended below) to clean the LCD 's surface with wipe lightly.
-IPA(Isopropyl Alcohol), Ethyl Alcohol, Trichlorotrifloroethane
- Do not wipe the LCD's surface with dry or hard materials that will damage the polarizers and others. Do not use the following solvent.
-Water, Ketone, Aromatics
- It is recommended that the LCD be handled with soft gloves during assembly, etc. The polarizers on the LCD's surface are vulnerable to scratch and thus to be damaged by sharp particles.
- Do not drop water or any chemicals onto the LCD's surface.
- A protective film is supplied on the LCD and should be left in place until the LCD is required for operation.
- The ITO pad area needs special careful caution because it could be easily corroded. Do not contact the ITO pad area with HCFC, Soldering flux, Chlorine, Sulfur, saliva or fingerprint. To prevent the ITO corrosion, customers are recommended that the ITO area would be covered by UV or silicon.

PRODUCT GROUP		REV	ISSUE DATE	
TFT- LCD PRODUCT		P0		
SPEC. NUMBER	SPEC. TITLE		PAGE	
S8-*	BA121S01-200 Product Specification		22 OF 25	

8.3 Caution Against Static Charge

- The LCD modules use C-MOS LSI drivers, so customers are recommended that any unused input terminal would be connected to Vdd or Vss, do not input any signals before power is turn on, and ground you body, work/assembly area, assembly equipments to protect against static electricity.
- Remove the protective film slowly, keeping the removing direction approximate 30-degree not vertical from panel surface, If possible, under ESD control device like ion blower, and the humidity of working room should be kept over 50%RH to reduce the risk of static charge.
- Avoid the use work clothing made of synthetic fibers. We recommend cotton clothing or other conductivity-treated fibers.
- In handling the LCD, wear non-charged material gloves. And the conducting wrist to the earth and the conducting shoes to the earth are necessary.

8.4 Caution For operation

- It is indispensable to drive the LCD within the specified voltage limit since the higher Voltage than the limit causes the shorter LCD's life. An electro-chemical reaction due to DC causes undesirable deterioration of the LCD so that the use of DC drive should avoid.
- Do not connect or disconnect the LCD to or from the system when power is on.
- Never use the LCD under abnormal conditions of high temperature and high humidity.
- When expose to drastic fluctuation of temperature (hot to cold or cold to hot) ,the LCD may be affected; Specifically, drastic temperature fluctuation from cold to hot ,produces dew on the LCD's surface which may affect the operation of the polarizer and the LCD.
- Response time will be extremely delayed at lower temperature than the operating temperature range and on the other hand at higher temperature LCD may turn black at temperature above its operational range. However those phenomena do not mean malfunction or out of order with the LCD. The LCD will revert to normal operation once the temperature returns to the recommended temperature range for normal operation.
- Do not display the fixed pattern for a long time because it may develop image sticking due to the LCD structure. If the screen is displayed with fixed pattern, use a screen saver.

PRODUCT GROUP		REV	ISSUE DATE	
TFT- LCD PRODUCT		P0		
SPEC. NUMBER	SPEC. TITLE		PAGE	
S8-*	BA121S01-200 Product Specification		23 OF 25	

8.5 Packaging

- Modules use LCD element, and must be treated as such.
 - Avoid intense shock and falls from a height.
 - To prevent modules from degradation, do not operate or store them exposed directly to sunshine or high temperature/humidity for long periods.

8.6 Storage

- A slight dew depositing on terminals is a cause for electro-chemical reaction resulting in terminal open circuit. Relative humidity of the environment should therefore be kept below 60%RH.
- Original protective film should be used on LCD' s surface (polarizer). Adhesive type protective film should be avoided, because it may change color and/or properties of the polarizers.
- Do not store the LCD near organic solvents or corrosive gasses.
- Keep the LCD safe from vibration, shock and pressure.
- Black or white air-bubbles may be produced if the LCD is stored for long time in the lower temperature or mechanical shocks are applied onto the LCD.
- In the case of storing for a long period of time for the purpose or replacement use, the following ways are recommended.
 - Store in a polyethylene bag with sealed so as not to enter fresh air outside in it.
 - Store in a dark place where neither exposure to direct sunlight nor light is.
 - Keep temperature in the specified storage temperature range.
 - Store with no touch on polarizer surface by the anything else. If possible, store the LCD in the packaging situation LCD when it was delivered.

8.7 Safety

- For the crash damaged or unnecessary LCD, it is recommended to wash off liquid crystal by either of solvents such as acetone and ethanol an should be burned up later.
- In the case the LCD is broken, watch out whether liquid crystal leaks out or not. If your hands touch the liquid crystal, wash your hands cleanly with water an soap as soon as possible.
- If you should swallow the liquid crystal, first, wash your mouth thoroughly with water, then drink a lot of water and induce vomiting, and then, consult a physician.
- If the liquid crystal should get in your eyes, flush your eyes with running water for at least fifteen minutes.
- If the liquid crystal touches your skin or clothes, remove it and wash the affected part of your skin or clothes with soap and running water.

PRODUCT GROUP		REV	ISSUE DATE	BOE
TFT- LCD PRODUCT		P0		
SPEC. NUMBER	SPEC. TITLE		PAGE	
S8-*	BA121S01-200 Product Specification		24 OF 25	

9.0 APPENDIX

Mechanical Drawing

Drawing Attachment: Front

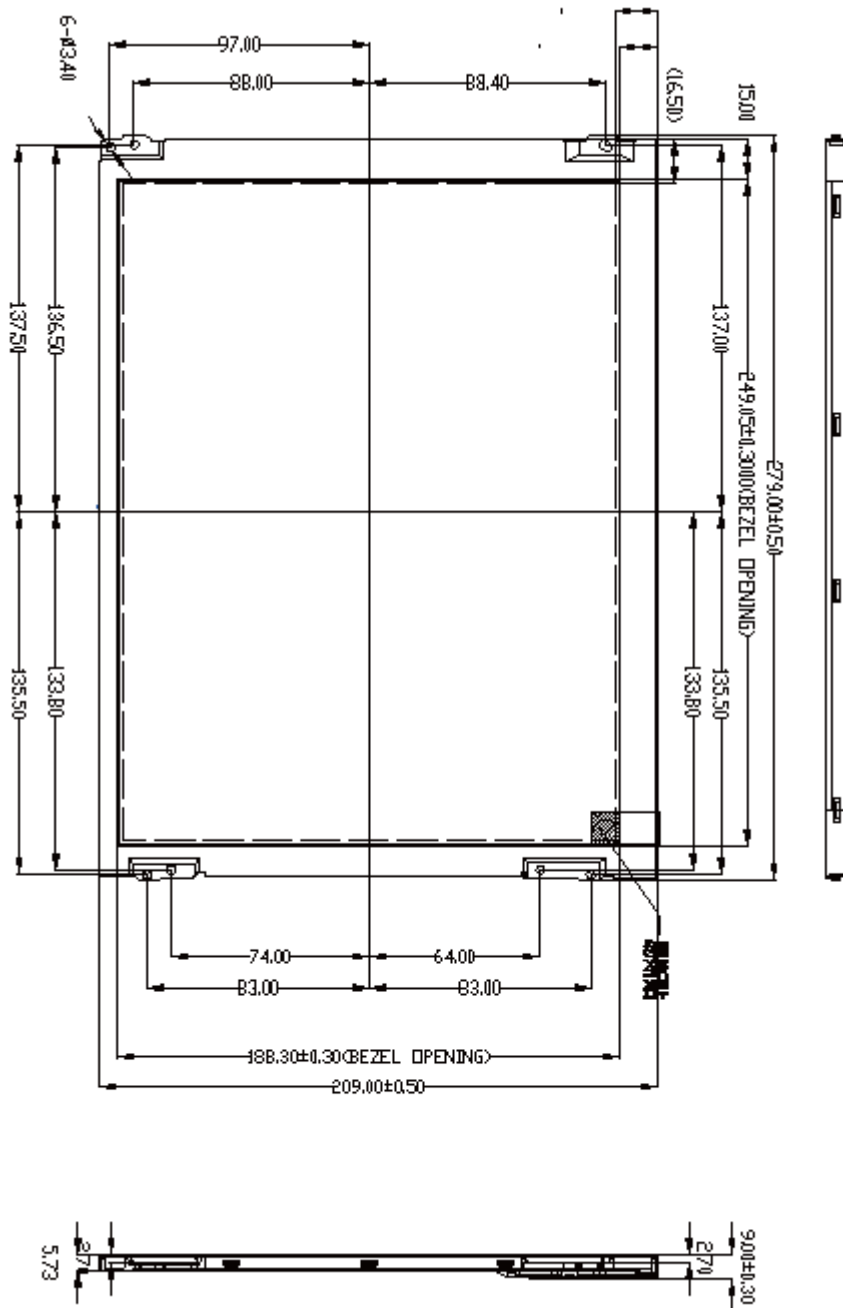

PRODUCT GROUP

REV

ISSUE DATE



TFT- LCD PRODUCT

P0

SPEC. NUMBER

SPEC. TITLE

PAGE

S8-*

BA121S01-200 Product Specification

29 OF 25

Mechanical Drawing
Drawing Attachment: Back

