

## HITACHI Specification for TX38D31VC1CAA

Date: July 2000

**TECHNICAL DATA****TENTATIVE SPECIFICATIONS  
OF 15" TFT-LCD MODULE****TX38D31VC1CAA****CONTENTS**

No.	Item	Sheet No.	Page
-	COVER	3284STD 0734-1	1-1/1
-			
-	DESCRIPTION	3284STD 0734-1	3-1/1
1	ABSOLUTE MAXIMUM RATINGS	3284STD 0734-1	4-1/1
2	OPTICAL CHARACTERISTICS	3284STD 0734-1	5-1/2~2/2
3	ELECTRICAL CHARACTERISTICS	3284STD 0734-1	6-1/1
4	INTERFACE PIN CONNECTION	3284STD 0734-1	7-1/2~2/2
5	INTERFACE TIMING	3284STD 0734-1	8-1/1
6	DESIGNATION OF LOT MARK	3284STD 0734-1	9-1/1
7	DIMENSIONAL OUTLINE	3284STD 0734-1	10-1/2~2/2
8			
9	PRECAUTIONS	3284STD 0734-1	12-1/3~3/3

## Notes :

1. The information contained herein is tentative and may be changed without prior notices.
2. Please contact Hitachi before proceeding to the design of your product.

## DESCRIPTION

The specifications are applied to the following TFT-LCD Modules.

Note : Inverter device for Back-Light is not built in the module.

Type Name: TX38D31VC1CAA

### General Specifications

Effective Display Area	H 304.128 × V 228.096	(mm)
Resolution	XGA	
Number of Pixels	H 1024 × V 768	(pixels)
Pixel Pitch	H 0.297 × V 0.297	(mm)
Color Pixel Arrangement	R•G•B Vertical Stripe	
Display Mode	Transmissive Mode, Normally White Mode	
Top polarizer Type	Anti-glare	
Number of Colors	16,777,216	(colors)
Viewing Angle	6:00 Direction	
Input Signal	TTL compatible, 2 pixel	
Back-Light	2 pcs. of CFL (Edge Light 1 pcs. at each top and bottom side)	
External Dimensions	H 335.2 × V 254 × t 13.5	(mm)
Weight	Max. 1400	(g)

Note CFL : Cathode Fluorescent Lamp

# 1. ABSOLUTE MAXIMUM RATINGS

## 1.1 ENVIRONMENTAL ABSOLUTE MAXIMUM RATINGS

Item	Operation		Non-operation		Unit	Note
	Min.	Max.	Min.	Max.		
Temperature	0	50	-20	60	°C	1)
Humidity	2)		2)		%RH	1)
Vibration	--	4.9 (0.5G)	--	19.6 (2G)	m/s <sup>2</sup>	3)
Shock	--	29.4 (3G)	--	294 (30G)	m/s <sup>2</sup>	4)
Corrosive Gas	Not Acceptable		Not Acceptable			
Illumination at LCD Surface	--	50,000	--	50,000	lx	

Notes 1) "Temperature" and "Humidity" shall be at glass surface of a TFT-LCD Module, not in the system installed with the Module. Operation shall be at the temperature below 60°C at rear surface center. The brightness of a CFL in the Back-Light unit drops at lower temperature. Besides, the life of the CFL gets shorter at lower temperature.

2)  $T_a \leq 40^\circ\text{C}$  -- • Humidity shall be less than 85 % RH Max. .  
• Non condensation

$T_a > 40^\circ\text{C}$  -- • Absolute humidity shall be lower than the saturated vapor of the 85 % RH at 40 °C.  
• Dew is prohibited.

3) Frequency of the vibration shall be between 20 Hz and 50 Hz. (except resonance point)

4) Pulse width of the shock shall be 7 ms.

## 1.2 ELECTRICAL ABSOLUTE MAXIMUM RATINGS

### (1) TFT-LCD MODULE

VSS=0V

Item	Symbol	Min.	Max.	Unit	Note
Power Supply Voltage for logic	VDD	0	6	V	
Input signal Voltage for logic	VI	-0.3	3.3 +0.3	V	1)
Electrostatic Durability	VESD0	± 100		V	2), 3)
	VESD1	± 8		kV	2), 4)

Notes 1) The specification shall be applied to pixel data signal and clock signal.

2) Discharge circuit to be connected : 200 pF - 250 Ω, Environmental : 25°C - 70 % RH

3) The specification shall be applied to I/F connector pins.

4) The specification shall be applied to the surface of both a metal bezel and a LCD panel.

### (2) BACK-LIGHT UNIT

GND=0V

Item	Symbol	Min.	Max.	Unit	Note
Lamp Current	IL	-	7.5	mA <sub>rms</sub>	1)
Lamp Voltage	VL	-	2000	V <sub>rms</sub>	2)

Notes 1) The specification shall be applied to each CFL unit. (A CFL unit consists of two pieces of CFLs.)

2) The specification shall be applied at connector pins for back-light units at start-up.

## 2. OPTICAL CHARACTERISTICS

The following optical characteristics shall be measured during operation of the unit (TFT-LCD module and Back-Light) on the condition the measuring systems operation are stable. It takes about 30 minutes. The measured point shall be at the center of the LCD unless any specified. The ambient light excluding light from the backlight unit of the module shall be prohibited.

• Measuring equipment : Pritchard 1980A, or equivalent

Temperature of LCD = 25 °C, VDD = 5.0 V, V = 60 Hz, IL = 6.0mA

Item	Symbol	Conditions	Min.	Typ.	Max.	Unit	Note	
Contrast Ratio	CR	$\theta = 0^\circ$ 1)	(200)	(350)	—		2)	
Response Time	Fall		ton	—	57	—	ms	3)
	Rise		toff	—		—	ms	3)
Brightness (White)	Bwh		(200)	250	—	cd/m <sup>2</sup>		
Brightness Uniformity	Buni		—	(80)	—	%	4)	
Color Position on CIE	Red		x	—	0.58	—	---	Gray scale -255th level (Maximum)
			y	—	0.34	—		
	Green		x	—	0.30	—		
			y	—	0.57	—		
	Blue		x	—	0.15	—		
		y	—	0.15	—			
	White	x	—	0.31	—			
		y	—	0.33	—			

( ) : Target Specification

Notes 1) Definition of Viewing Angle

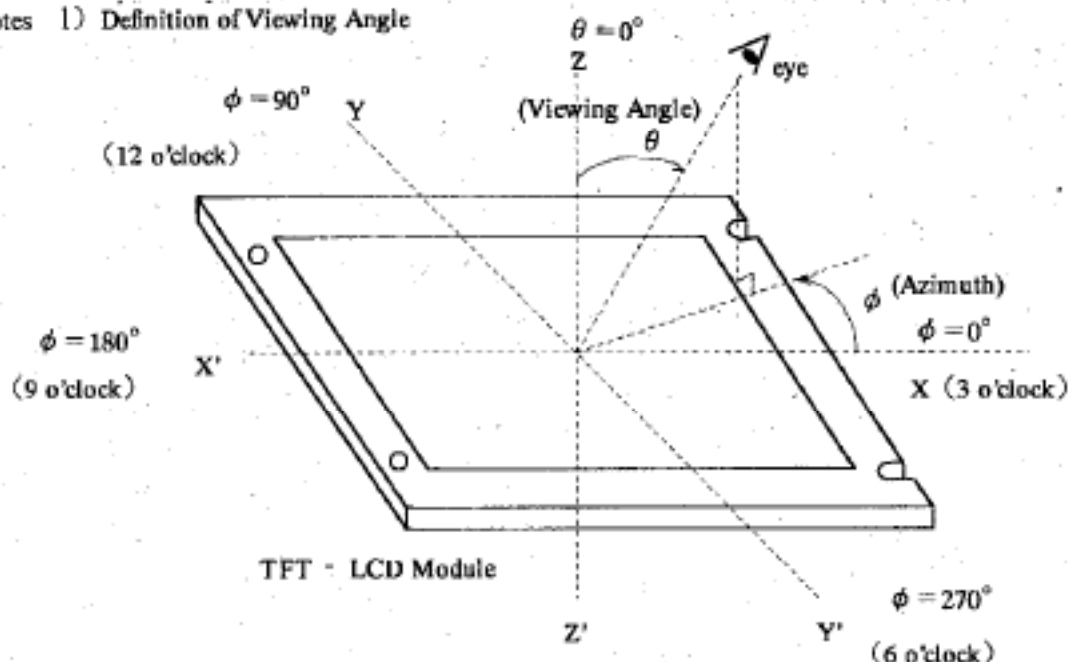

2) Definition of Contrast Ratio(CR):

$$CR = \frac{\text{(Luminance at displaying WHITE)}}{\text{(Luminance at displaying BLACK)}}$$

3) Definition of Response Time

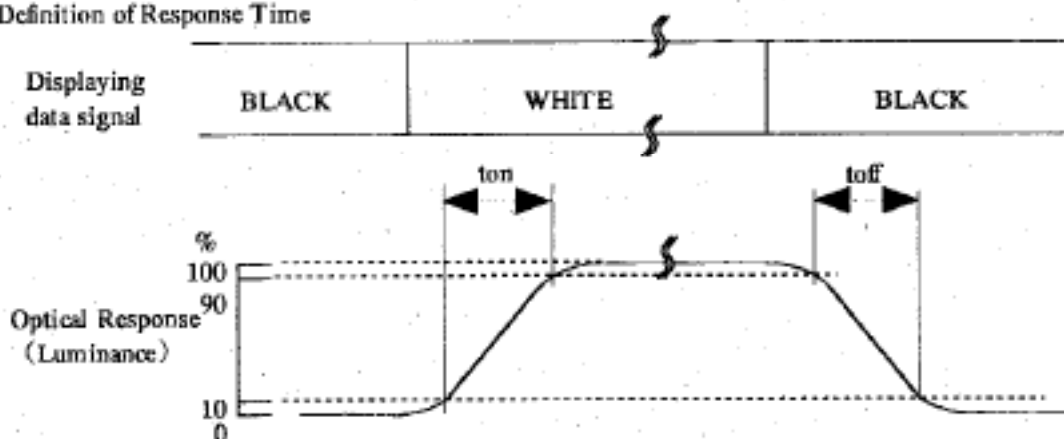

4) Definition of Brightness Uniformity

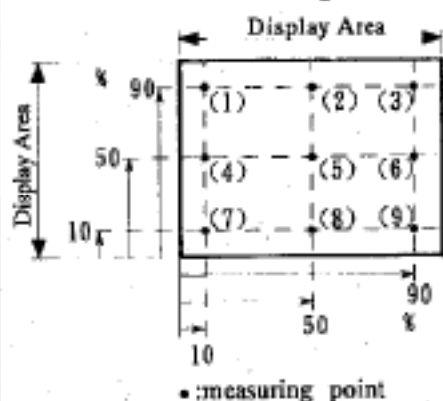

The brightness uniformity (Buni) is defined as the following equation.

$$Buni = \frac{Bmin}{Bmax} \times 100$$

where, Bmax = Maximum brightness among 9 measuring points  
 Bmin = Minimum brightness among 9 measuring points

(Display Pattern) Gray scale=255th level

### 3. ELECTRICAL CHARACTERISTICS

#### 3.1 TFT-LCD MODULE

VDD=5.0V, Ta=25°C, VSS=0V

Item	Symbol	Min.	Typ.	Max.	Unit	Note
Power Supply Voltage	VDD	4.5	5	5.5	V	
Power Supply Current	IDD	—	TBD	—	mA	1)
VSYNC Frequency	fV	(50)	60	(75)	Hz	
HSYNC Frequency	fH	TBD	48.4	TBD	kHz	
DCLK Frequency	fCLK	(55)	65	(80)	MHz	
Input Signals	VI	—	—	—	V	

Notes 1) DC current at fV=60Hz, fCLK=65 MHz, VDD=5.0V, and All white screen

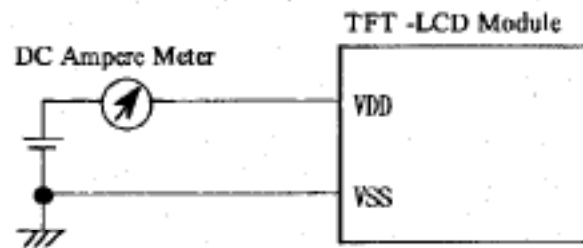

2) ( ): Target Specification

#### 3.2 BACK-LIGHT UNIT

Ta=25°C

Item	Symbol	Min.	Typ.	Max.	Unit	Note
Lamp Current	IL	(1)	—	7	mA <sub>rms</sub>	1), 4)
Lamp Voltage	VL	—	TBD	—	V <sub>rms</sub>	5)
Frequency	fL	50	—	60	kHz	2)
Starting Lamp Voltage	VS	(1500)	1600	(1950)	V <sub>rms</sub>	3)

Notes

- 1) Larger IL causes the shorter life of a lamp CFL.
- 2) Frequency of power supply for a CFL may cause interference with HSYNC frequency and causes beat or flicker on the display. Therefore, lamp frequency shall be as different as possible from HSYNC frequency in order to avoid the interference.
- 3) Ta = 0 °C
- 4) The specification shall be applied to each CFL unit. (A CFL unit consists of two pieces of CFL.)
- 5) Lamp Voltage is measured as below.
- 6) ( ): Target Specification

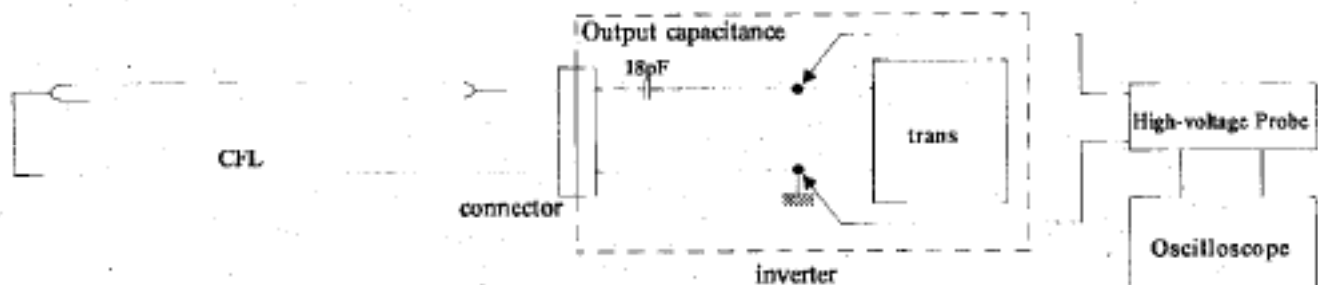

## 4. INTERFACE PIN CONNECTION

### 4.1 TFT-LCD MODULE

CN1 :53475 (molex)

Pin No.	Symbol	Description	Note	Pin No.	Symbol	Description	Note
1	VSS	GND(0V)		41	VSS	GND(0V)	
2	PEV B0	Pixel Data	1)	42	POD G0	Pixel Data	1)
3	PEV B1	Pixel Data	1)	43	POD G1	Pixel Data	1)
4	PEV B2	Pixel Data		44	POD G2	Pixel Data	
5	PEV B3	Pixel Data		45	POD G3	Pixel Data	
6	VSS	GND(0V)		46	VSS	GND(0V)	
7	PEV B4	Pixel Data		47	POD G4	Pixel Data	
8	PEV B5	Pixel Data		48	POD G5	Pixel Data	
9	PEV B6	Pixel Data		49	POD G6	Pixel Data	
10	PEV B7	Pixel Data		50	POD G7	Pixel Data	
11	VSS	GND(0V)		51	VSS	GND(0V)	
12	PEV G0	Pixel Data	1)	52	POD R0	Pixel Data	1)
13	PEV G1	Pixel Data	1)	53	POD R1	Pixel Data	1)
14	PEV G2	Pixel Data		54	POD R2	Pixel Data	
15	PEV G3	Pixel Data		55	POD R3	Pixel Data	
16	VSS	GND(0V)		56	VSS	GND(0V)	
17	PEV G4	Pixel Data		57	POD R4	Pixel Data	
18	PEV G5	Pixel Data		58	POD R5	Pixel Data	
19	PEV G6	Pixel Data		59	POD R6	Pixel Data	
20	PEV G7	Pixel Data		60	POD R7	Pixel Data	
21	VSS	GND(0V)		61	VSS	GND(0V)	
22	PEV R0	Pixel Data	1)	62	VSS	GND(0V)	
23	PEV R1	Pixel Data	1)	63	PDCLK	Pixel Dot Clock	
24	PEV R2	Pixel Data		64	VSS	GND(0V)	
25	PEV R3	Pixel Data		65	VSS	GND(0V)	
26	VSS	GND(0V)		66	PDHS	Hsync.	
27	PEV R4	Pixel Data		67	VSS	GND(0V)	
28	PEV R5	Pixel Data		68	VSS	GND(0V)	
29	PEV R6	Pixel Data		69	PDEN	DTMG	
30	PEV R7	Pixel Data		70	PDVS	Vsync.	
31	VSS	GND(0V)		71	VDD	Power Supply(typ.+5V)	
32	POD B0	Pixel Data	1)	72	VDD	Power Supply(typ.+5V)	
33	POD B1	Pixel Data	1)	73	VDD	Power Supply(typ.+5V)	
34	POD B2	Pixel Data		74	VDD	Power Supply(typ.+5V)	
35	POD B3	Pixel Data		75	VDD	Power Supply(typ.+5V)	
36	VSS	GND(0V)		76	VSS	GND(0V)	
37	POD B4	Pixel Data		77	P ID2	NC	
38	POD B5	Pixel Data		78	P ID1	NC	
39	POD B6	Pixel Data		79	FRC_CTL	8bit+5V,6bit:GND	
40	POD B7	Pixel Data		80	VSS	GND(0V)	

Note:

1)6bit Mode shall be connected to VSS.



## 4.2 BACK-LIGHT UNIT

CN2, CN3 : BHR-03VS-1 ( J.S.T.)

Pin No.	Symbol	Description	Note
1	VL	Power Supply	
2	NC	No connection	
3	GND	GND(0V)	

## 5. INTERF TIMING

### 5.1 INTERFACE TIMING SPECIFICATIONS

Item		Symbol	Min.	Typ.	Max.	Unit	Note
DCLK	Period	TCIP	25	—	—	ns	
	Duty	D	0.35	0.5	0.65		D=TCIL/TCIP
HSYNC	Period	THP	TBD	—	860	TCIP	
	Width-Active	TWH	4	—	120	TCIP	
VSYNC	Set up Time	TSV	0	—	—	TCIP	to HSYNC
	Hold Time	THV	2	—	—	TCIP	
	Period	TVP	772	—	1000	THP	
	Width-Active	TWV	1	—	120	THP	
DTMG	Horizontal Back porch	THBP	TBD	—	250	TCIP	
	Horizontal Front Porch	THFP	0	—	1)	TCIP	
	Vertical Back Porch	TVBP	3	—	2)	THP	
	Vertical Front porch	TVFP	0	—	2)	THP	
	Width-Active	TWD	512	—	—	TCIP	
COMMON	Set up Time	TSTC	TBD	—	3)	ns	
	Hold Time	THTC	TBD	—	3)	ns	

In addition to the above, these timing should conform to the followings.

Note 1)  $T_{HBP} + T_{HFP} \leq 357TCIP$

2)  $T_{VBP} + T_{VFP} \leq 253THP$

3)  $f_v = 1/TVP \leq 75Hz$

4)  $f_H = 1/TVP \leq 60.24kHz$

### 5.2 TIMING BETWEEN INTERFACE SIGNAL AND POWER SUPPLY

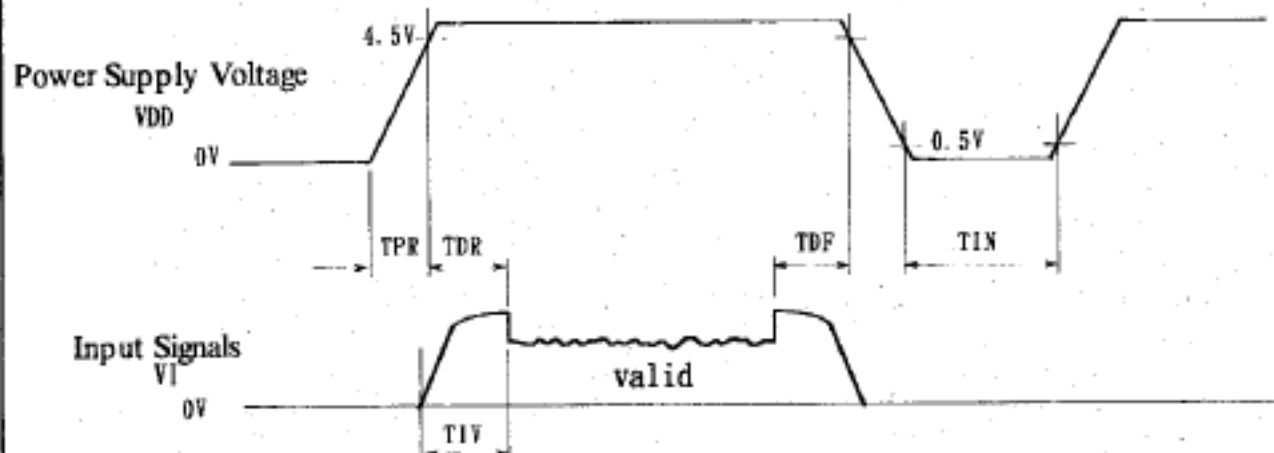

Timing of power supply voltage and input signals shall be specified as the followings.

$$0ns \leq T_{PR} \leq 20ns$$

$$0ns \leq T_{DR} \leq 20ns$$

$$0ns \leq T_{DF} \leq 50ns$$

$$T_{IN} \geq 200ms$$

$$T_{IV} \geq TBD$$

## 6. DESIGNATION OF LOT MARK

### 6.1 LOT MARK

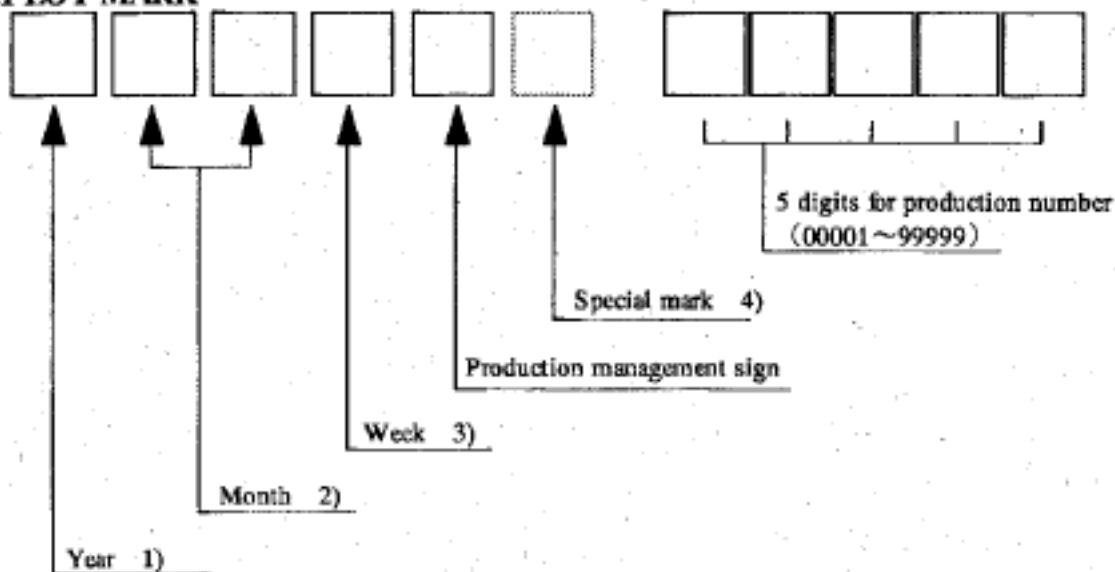

#### Notes

Year	Mark
1999	9
2000	0
2001	1
2002	2
2003	3
2004	4

Month	Mark	Month	Mark
1	01	7	07
2	02	8	08
3	03	9	09
4	04	10	10
5	05	11	11
6	06	12	12

Week (Days)	Mark
1~7	1
8~14	2
15~21	3
22~28	4
29~31	5

4) The special mark may be added by manufacturing accordingly to production number.

### 6.2 LOCATION OF LOT MARK

Lot mark is printed on a label. The label is on the metal bezel as shown in the drawing at Section 7. The style of character may be changed without notice.



7. DIMENSIONAL OUTLINE  
(1) FRONT SIDE

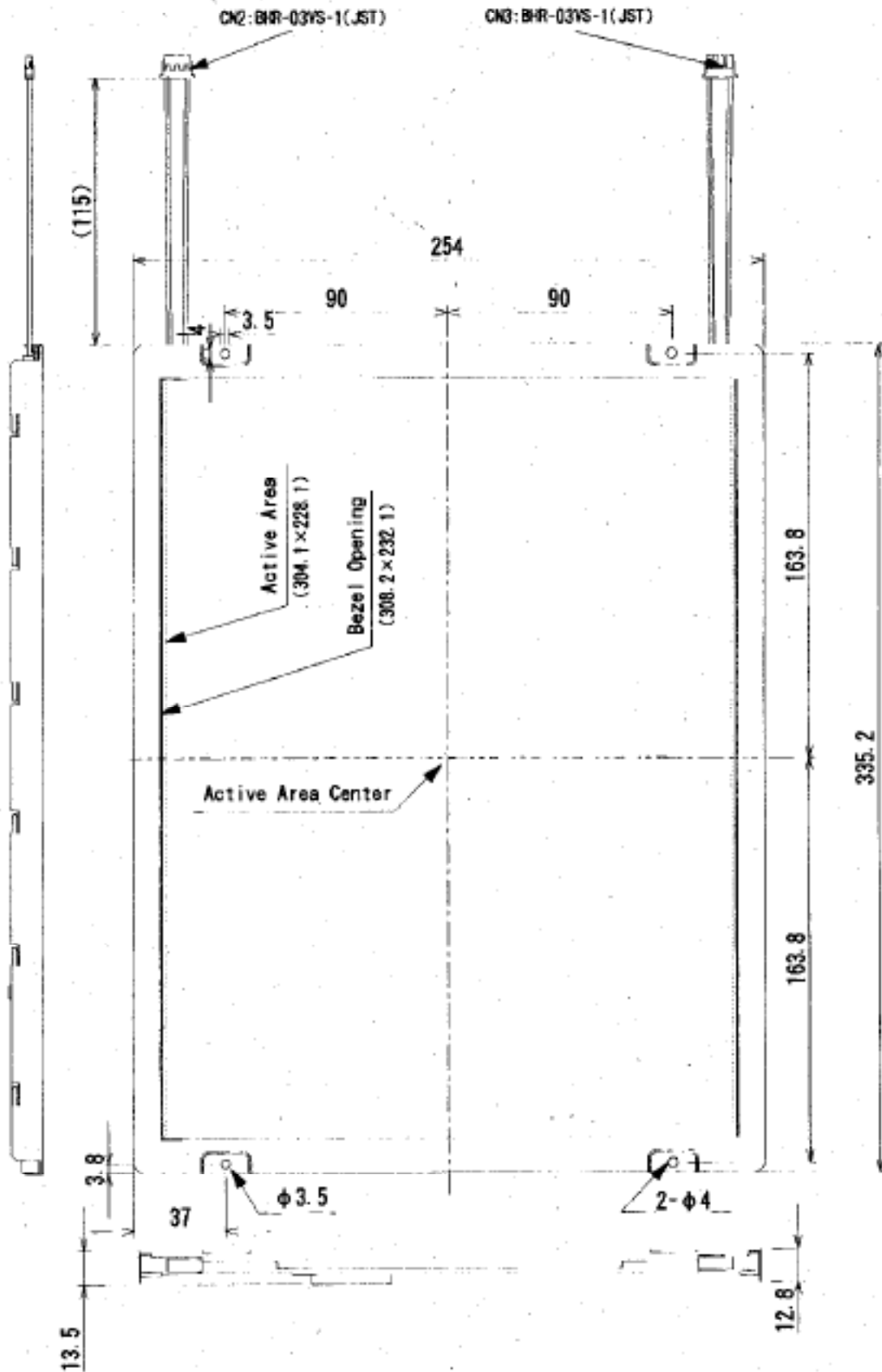

Unit:mm  
Scale:NTS

(2)BACK SIDE

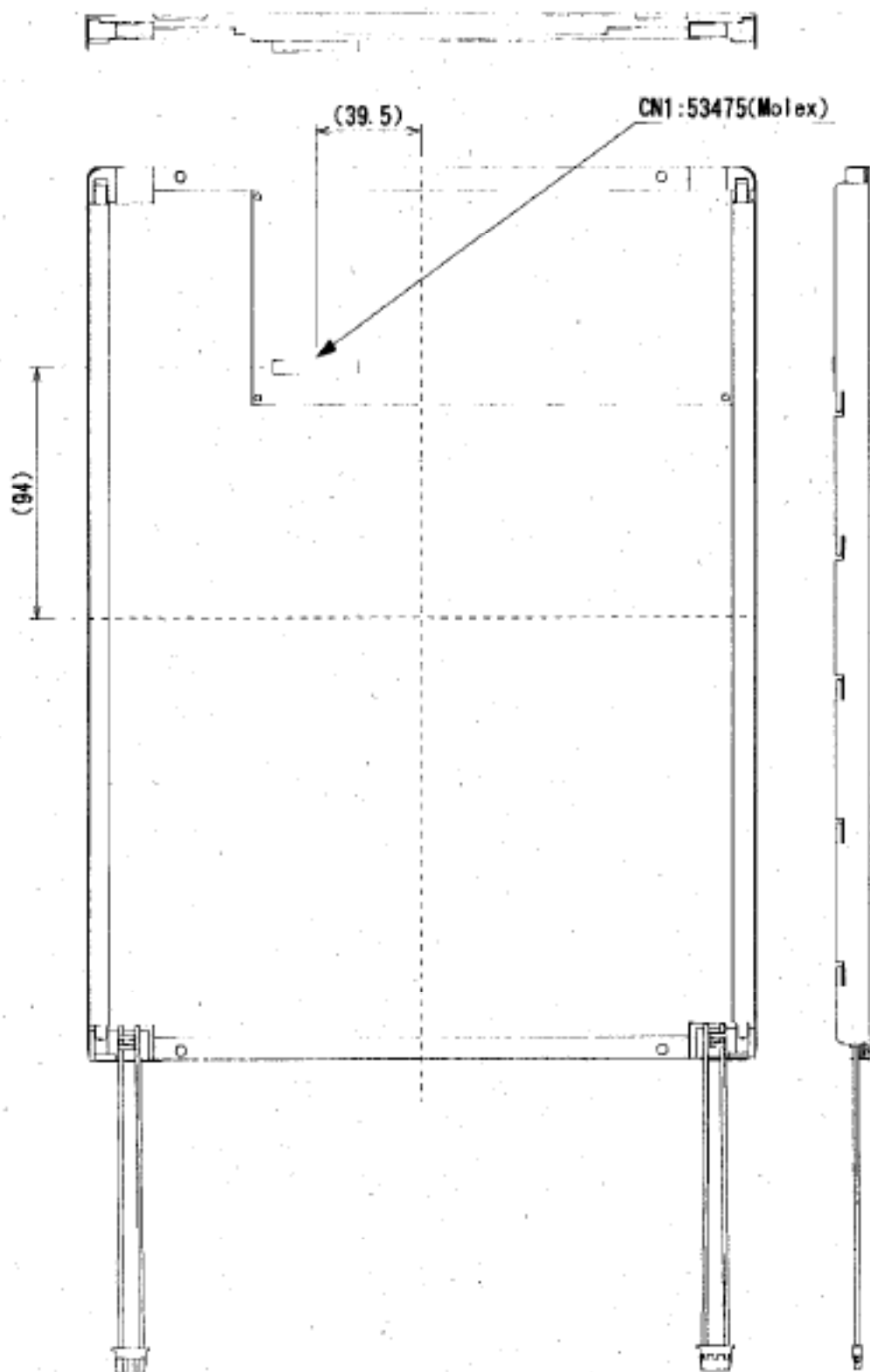

Unit:mm  
Scale:NTS

## 9. PRECAUTIONS

Please pay attention to the followings when the TFT-LCD module with the Back-light unit is used, handled and mounted.

### 9.1 PRECAUTIONS TO MOUNTING

- (1) Since the module is thin and heavy, applying strong force to a part of the module may cause partial deformation of frame or mold, and cause damage to the display.
- (2) The module shall gently and firmly be held by both hands. Never hold the longer side of the module by just one hand in order to avoid any internal damage. Never drop or hit the module. Never make any pressure on the display surface.
- (3) The module shall be installed with mounting holes at each corner of the module with an appropriate torque, 0.6N·m or less should be recommended.
- (4) Uneven force such as twisted stress shall not be applied to the module when the module is mounted on the cover case. And, the cover case must have sufficient strength so that external force can not be transmitted directly to the module.
- (5) The space between the edge side of the back of the module and the cover case shall be 1.0mm or more, in order to suppress bending potential of the module. ( See Fig. 1 )

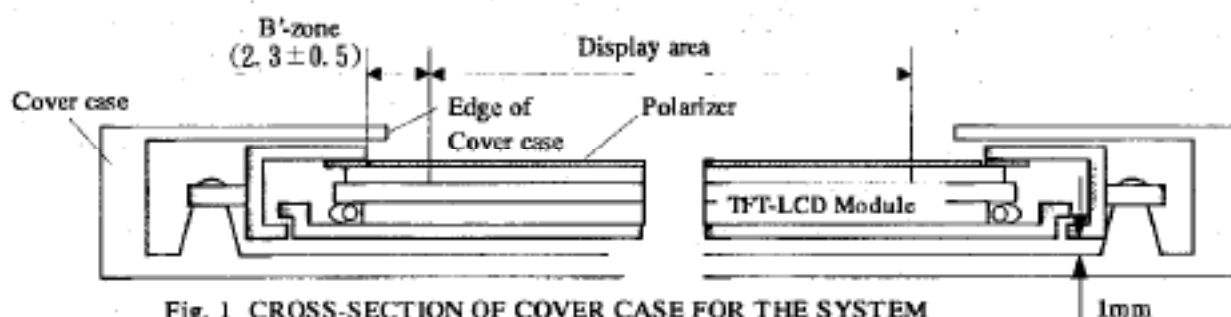
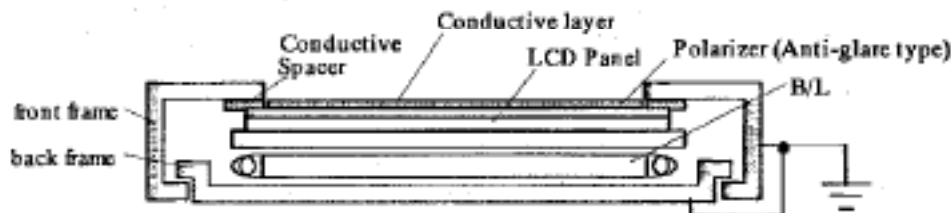

Fig. 1 CROSS-SECTION OF COVER CASE FOR THE SYSTEM

- (6) The edge of the cover case shall be located more than 1 mm from the edge of the module front frame.
- (7) When a transparent protective plate will be added on the displaying area of the module in order to protect polarizer and TFT-LCD cell, the transparent protective plate shall have sufficient strength so that the plate can not touch the module by external force.
- (8) Materials with acetic acid type or choline type shall not be used for the cover case as well as other parts and boards near the module. Because, gases from the materials at higher temperature are corrosive and attack the module. Acetic acid type attacks the polarizer. Choline type attacks electric circuits due to electro-chemical reaction.
- (9) The polarizer on the TFT-LCD cell shall carefully be handled due to its softness, and shall not be touched, pushed or rubbed with glass, tweezers or anything harder than HB pencil lead. The surface of the polarizer shall not be touched and rubbed with bare hand, greasy clothes or dusty clothes with chemical treatment. (Some cosmetics are detrimental to the polarizer.)
- (10) The surface of the polarizer shall be gently wiped with absorbent cotton, chamois or other soft materials slightly contained petrolcum benzene when the surface becomes dirty.
- (11) Normal-Hexane as cleaning chemicals is recommended in order to clean the adhesives which fix front / rear polarizers on the TFT-LCD cell. Other cleaning chemicals such as acetone, toluen and alcohol shall not be used to the adhesives because they cause chemical damage to the polarizer.
- (12) Saliva or water drops shall be immediately wiped off. Otherwise, the portion of the polarizer may be deformed and its color may be fided.
- (13) The module shall not be opened or modified. Otherwise, it may cause malfunctions.
- (14) Metallic bezel of the module shall not be handled with bare hand or dirty gloves. Otherwise, color of the metallic frame may become dirty during its storage. It is recommended to use both clean soft gloves and clean finger stalls when the module is handled at incoming inspection process and production (assembly) process.
- (15) The cable for lamp(CFL) shall not be pull or held. Interface cable shall be installed with an appropriate procedure.

## 9.2 PRECAUTIONS TO OPERATION

- (1) The ambient temperature near the operated module shall be satisfied with the absolute maximum ratings. Unless it meets the specifications, sufficient cooling system shall be adopted to the cover case.
- (2) The spike noise causes the mis-operation of the module. The level of the spike noise shall be as follows :  
-  $200 \text{ mV} \leq \text{over- and under- shoot of VDD} \leq +200 \text{ mV}$   
VDD including over- and under- shoot shall be satisfied with the absolute maximum ratings.
- (3) Optical response time, luminance and chromaticity depend on the temperature of the TFT-LCD cell. It would be realized that the response time becomes longer at lower temperature operation. Besides, it would also be realized that the time to saturate luminance of the lamp(CFL) becomes longer at lower temperature operation.
- (4) Sudden temperature change may cause dew on and/or in the module. Dew makes damage to polarizer and/or electrical contacting portion. And dew causes fading of displayed quality such as smear, spot and soon.
- (5) Fixed patterns displayed on the module for a long time may cause after-image. It will be recovered sooner or later.
- (6) Module has high frequency circuits. Sufficient suppression to the electromagnetic interference shall be done by system manufacturers. Grounding and shielding methods may be important to minimize the radiation.
- (7) Noise may bear when a back-light unit is operated. If necessary, sufficient suppression shall be done by system manufacturers.
- (8) The cable between the back-light connector and its inverter power supply shall be a minimized length and be connected directly. The longer cable between the back-light and the inverter may cause lower luminance of lamp(CFL) and may require higher starting lamp voltage (VS).
- (9) The module shall not be connected or disconnected while a main system is still on.
- (10) To avoid after image, it is recommended not to display a still image for a long time, and not to apply any direct current as display data to the LCD. Especially, display data shall be carefully checked at the output of data processing circuits in the I/F board, such as frame rate control.
- (11) The glass surface is coated with a conductive layer (ITO layer) as shown in the figure. This layer is electrically connected to the front metal frame through the conductive spacer. Both of the front and back metal frames should be electrically connected to your system ground using the mountain holes.



## 9.3 ELECTROSTATIC DISCHARGE CONTROL

- (1) Since the module consists of TFT-LCD cell and electronic circuits with CMOS-ICs, which are very weak to electrostatic discharge, persons who are handling the module shall be grounded through adequate methods such as list band. Pins of I/F connector shall not be touched directly with bare hands.
- (2) Protection film for polarizer on the module shall be slowly peeled off just before the use so that the electrostatic charge can be minimized.

## 9.4 PRECAUTIONS TO STRONG LIGHT EXPOSURE

- (1) The module shall not be exposed under strong light. Otherwise, characteristics of the polarizer and color filter in the module may be degraded.

## 9.5 PRECAUTIONS TO STORAGE

When the module for replacement are stored for long time, following precautions shall be taken care of:

- (1) The module shall be stored in a dark place. It is prohibited to apply sunlight or fluorescent light during the storage. The module shall be stored at 5 to 35 °C at normal humidity (60 % RH or less).
- (2) The surface of the polarizer shall not come in contact with any other object. It is recommended that the module shall be stored in the same shipping container that Hitachi used.

## 9.6 PRECAUTIONS TO HANDLING PROTECTION FILM

- (1) The protection film for polarizer shall be peeled off slowly and carefully by persons who are electrically grounded with adequate methods such as list band. Besides, ionized air shall be blown over during the peeling action. Dusts on the polarizer shall be blown off by an ionized nitrogen gun and so on.
- (2) The protection film shall be peeling off without rubbing it to the polarizer. Because, if the film is rubbed together with the polarizer, since the film is attached to the polarizer with a small amount of adhesive, the adhesive may remain on the polarizer.
- (3) The module with protection film shall be stored at the conditions explained in (1) of 10.5. However, if the storing time is too long, the adhesive may remain on the polarizer even after the protection film is slowly peeled off. If the module is stored at higher temperature and/or higher humidity, the adhesive may remain more on the polarizer. The remained adhesive may causes non-uniformity.
- (4) The adhesive can be removed easily with Normal-Hexane. The remained adhesive or its vestige on the polarizer shall be wiped off with absorbent cotton or other soft materials such as chamois slightly contained Normal-Hexane.

## 9.7 SAFETY

- (1) Since TFT-LCD cell and lamp(CFL) are made of glass, handling to the broken module shall be taken care sufficiently in order not to be injured. Hands touched the liquid crystal from the broken cell shall be washed sufficiently.
- (2) Electrically conductive wire shall not be inserted in the CFL units. Because, the unit has a high voltage circuit internally.

## 9.8 ECOLOGY

- (1) The Lamp of backlight has a little mercury. Please handle it appropriately in case of disposal.
- (2) Flex cable and Printed wire Board have a little lead : Therefore, handle them appropriately in case of disposal.

## 9.9 USE RESTRICTIONS AND LIMITATIONS

- (1) This product is not authorized for use in life support devices or systems, military applications, or other applications which pose a significant risk of personal injury. Therefore, the product shall not be used for such purposes.
- (2) In no event shall Hitachi, Ltd., be liable for any incidental, indirect, or consequential damages in connection with the installation or use of this product, even if informed of the possibility thereof in advance. These limitations apply to all causes of action in the aggregate, including without limitation breach of contract, breach of warranty, negligence, strict liability, misrepresentation and other torts.

## 9.10 OTHERS

- (1) Electrical components which may not affect electrical performance are subjective to change without notice because of their availability etc.



# DATA MODUL

DISPLAY AND SYSTEM SOLUTIONS



#### **Data Modul Aktiengesellschaft**

Landsberger Str. 322 D-80687 München  
Tel.: +49 -89 -56017 -0  
Fax: +49 -89 -56017 -119



#### **Data Modul Sales Office Hamburg**

An der Alster 48 D-20099 Hamburg  
Tel.: +49 -40 -280158 -0  
Fax: +49 -40 -280158 -19



#### **Data Modul Sales Office Düsseldorf**

Fritz-Vomfelde-Str. 8 D-40547 Düsseldorf  
Tel.: +49 -211 -52709 -0  
Fax: +49 -211 -52709 -19



#### **Data Modul Sales Office Frankfurt**

Am Lachengraben 7 D-63303 Frankfurt  
Dreieich Tel.: +49 -6103 -80288 -2  
Fax: +49 -6103 -80288 -3



#### **Data Modul Sales Office Stuttgart**

Friedrich-List-Str. 42 D-70771 Leinfelden-  
Echterdingen Tel.: +49 -711 -794613 -5  
Fax: +49 -711 -794613 -7

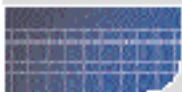

#### **Data Modul Inc.**

120 Commerce Drive  
11788 Hauppauge New York, USA  
Tel.: +1 -631 -951 -0800  
Fax: +1 -631 -951 -2121

[www.data-modul.de](http://www.data-modul.de)  
[info@data-modul.de](mailto:info@data-modul.de)