



PROPRIETARY NOTE

THIS SPECIFICATION IS THE PROPERTY OF BOE HYDIS AND SHALL NOT BE REPRODUCED OR COPIED WITHOUT THE WRITTEN PERMISSION OF BOE HYDIS AND MUST BE RETURNED TO BOE HYDIS UPON ITS REQUEST

TITLE : HTT22QC2–D00(Panel)

Product Specification

Rev. 0

BOE HYDIS TECHNOLOGY

SPEC. NUMBER
S863-1066

PRODUCT GROUP
TFT PRODUCTS

REV.
0

ISSUE DATE
2007.11.16

PAGE
1 OF 23



PRODUCT GROUP

REV

ISSUE DATE

TFT PRODUCTS

0

2007.11.16

REVISION HISTORY

REV.	ECN NO.	DESCRIPTION OF CHANGES	DATE	PREPARED
0		Initial Release	07.11.16	S.S Kim

SPEC. NUMBER
S863-1066

SPEC. TITLE
HTT22QC2-D00 Product Specification

PAGE
2 OF 23



PRODUCT GROUP

REV

ISSUE DATE

TFT PRODUCTS

O

2007.11.16

Contents

No	Item	Page
1.0	General Description	4
2.0	Absolute Maximum Ratings	5
3.0	Electrical Specifications	6
4.0	Optical Specifications	7
5.0	Mechanical Characteristics	9
6.0	Gate/Data IC PAD & FPC Pin Assignment	10
7.0	Reliability Test	14
8.0	Handling & Cautions	15
9.0	PACKING SPECIFICATION	18
10.0	LABEL MARKING	19
11.0	Appendix	20



PRODUCT GROUP

REV

ISSUE DATE

TFT PRODUCTS

O

2007.11.16

1.0 GENERAL DESCRIPTION

1.1 Introduction

2.2" QCIF is a color active matrix TFT LCD Panel using amorphous silicon TFT's (Thin Film Transistors) as an active switching devices. This panel has a 2.2 inch diagonally measured active area with QCIF resolutions (176 horizontal by 220 vertical pixel array). Each pixel is divided into RED, GREEN, BLUE dots which are arranged in vertical stripe and this panel can display 262,144 colors.

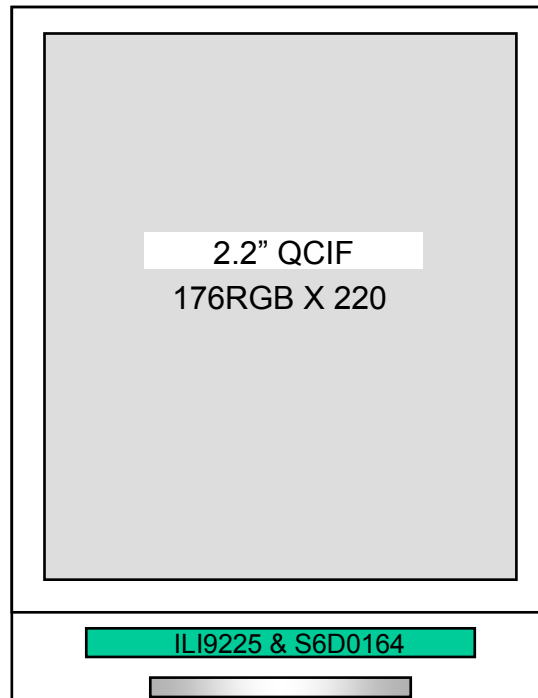

1.2 Features

- Thin and light weight
- Gate Design for 3-side free
- 0.5t Glass
- COG Design

1.3 Application

- Mobile Phone

SPEC. NUMBER
S863-1066

SPEC. TITLE
HTT22QC2-D00 Product Specification

PAGE
4 OF 23



PRODUCT GROUP

REV

ISSUE DATE

TFT PRODUCTS

O

2007.11.16

1.4 General Specifications

Parameter	Specification	Unit	Remarks
Active area	34.848(H) × 43.56mm (V)	mm	
Number of pixels	176 (H) × 220 (V)	pixels	
Pixel pitch	0.198 (H) × 0.198 (V)	mm	
Pixel arrangement	RGB Vertical stripe		
Color Gamut	60.0% (typ.)		
Display colors	262,144	colors	
Display operating mode	Transmissive mode, Normally White		
Dimensional outline	38.25±0.2(W) × 51.65±0.2(V) × 1.0±0.1(D)	mm	
D-IC	ILI9225 & S6D0164		
Weight	TBD	g	

2.0 ABSOLUTE MAXIMUM RATINGS

The followings are maximum values which, if exceed, may cause faulty operation or damage to the unit.

[VSS = GND = 0V]

Parameter	Symbol	Min	Max	Unit	Remark
LC Operating Voltage *1)	V _{op}		3.3	V	Ta = 25°C
Operating Temperature (Humidity)	T _{OP} RH	-20	+70 90	°C %	At 60 °C
Storage Temperature (Humidity)	T _{ST} RH	-30	+80 90	°C %	At 60 °C

*1) Liquid Crystal driving voltage

Due to the characteristics of LC Material, this voltage vary with environmental temperature.

SPEC. NUMBER
S863-1066

SPEC. TITLE
HTT22QC2-D00 Product Specification

PAGE
5 OF 23



3.0 ELECTRICAL SPECIFICATIONS

3.1 Electrical Characteristics

Parameter	Symbol	Value		Unit	Remarks
		Min	Max		
TFT Gate ON Voltage	VGH	12	18	V	Note 1
TFT Gate OFF Voltage	VGL	-12	-7	V	Note 2
TFT Common Electrode Voltage	VCom	-2	5	V	Note 3
TFT Kick-Back Voltage Max	ΔV_p Max	0.2	1.5	V	
TFT Kick-Back Voltage Min	ΔV_p Min	0.2	1.5	V	

<Table 1. Parameters for Electrical Characteristics>

Note :

1. VGH is TFT Gate operating voltage.
2. VGL is TFT Gate operating voltage. The low voltage level of VGL signal must be fluctuates with same phase as Vcom.
3. Vcom must be adjusted to optimize display quality, as Crosstalk and Contrast Ratio etc.



4.0 OPTICAL SPECIFICATION

4.1 Overview

The test of Optical specifications shall be measured in a dark room (ambient luminance ≤ 1 lux and temperature = $25 \pm 2^\circ\text{C}$) with the equipment of Luminance meter system (Goniometer system and TOPCONE BM-5) and test unit shall be located at an approximate distance 50cm from the LCD surface at a viewing angle of Θ and Φ equal to 0° . The center of the measuring spot on the Display surface shall stay fixed. The backlight should be operating for 30 minutes prior to measurement. Optimum viewing angle direction is 12 o'clock.

4.2 Optical Specifications

<Table 2. Optical Specifications>

Parameter		Symbol	Condition	Min.	Typ.	Max.	Unit	Remark
Threshold voltage		Vsat		2.2	2.3	2.4	V	Fig. 1
		Vth		1.3	1.4	1.5	V	
Viewing Angle range	Horizontal	Θ_3	CR > 10	40	45		Deg.	Note 1
		Θ_9		40	45		Deg.	
	Vertical	Θ_{12}		-	50		Deg.	
		Θ_6		-	20		Deg.	
Contrast ratio		CR	$\Theta = 0^\circ$	-	350	-		Note 2
Transmittance		T(%)	$\Theta = 0^\circ$	-	7	-		Note 3
White Chromaticity		x_w	$\Theta = 0^\circ$	0.287	0.307	0.327		Note 4 *Color Filter Glass
		y_w		0.315	0.335	0.355		
Reproduction Of color	Red	x_R	$\Theta = 0^\circ$	0.624	0.644	0.664		
		y_R		0.326	0.346	0.366		
	Green	x_G		0.285	0.305	0.325		
		y_G		0.561	0.581	0.601		
	Blue	x_B		0.115	0.135	0.155		
		y_B		0.116	0.136	0.156		
Response Time		Tr+Tf	$\Theta = 0^\circ$	-	25	-	msec	Note 5



PRODUCT GROUP

REV

ISSUE DATE

TFT PRODUCTS

O

2007.11.16

Note :

- 1. Viewing angle is the angle at which the contrast ratio is greater than 10. The viewing are determined for the horizontal or 3, 9 o'clock direction and the vertical or 6, 12 o'clock direction with respect to the optical axis which is normal to the LCD surface (see FIGURE 2 shown in Appendix).
- 2. Contrast measurements shall be made at viewing angle of $\Theta = 0^\circ$ and at the center of the LCD surface. Luminance shall be measured with all pixels in the view field set first to white, then to the dark (black) state. (See FIGURE 2 shown in Appendix) Luminance Contrast Ratio (CR) is defined mathematically.

$$CR = \frac{\text{Luminance when displaying a white raster}}{\text{Luminance when displaying a black raster}}$$

- 3. Transmittance is the value with Polarizer
- 4. The color chromaticity coordinates specified in Table 2 shall be calculated from the spectral data measured with all pixels first in red, green, blue and white. Measurements shall be made at the center of the C/F. Measurement condition is C - light source & Halogen Lamp.
- 5. The electro-optical response time measurements shall be made as FIGURE 3 shown in Appendix by switching the "data" input signal ON and OFF. The times needed for the luminance to change from 10% to 90% is T_r , and 90% to 10% is T_d .



5.0 MECHANICAL CHARACTERISTICS

5.1 Dimensional Requirements

FIGURE 4 shown in appendix shows mechanical outlines for the model.

Parameter	Specification	Unit
Active area	34.848 (H) × 43.56 (V)	mm
Number of pixels	176 (H) × 220(V)	pixels
	(1 pixel = R + G + B dots)	
Pixel pitch	0.198(H) × 0.198(V)	mm
Pixel arrangement	RGB Vertical stripe	
Display mode	Normally White	
Dimensional outline	38.25±0.2(W) × 51.65±0.2(V) × 1.0±0.1(D)	mm
Weight	TBD	gram



PRODUCT GROUP

REV

ISSUE DATE

TFT PRODUCTS

O

2007.11.16

6.0 Gate/Data IC PAD & FPC Pin Assignment

*unit : um

6.1 Gate/Data IC PAD (ILI9225)

Use ILI9225 & S6D064 in common

* Chip size : 13.88 X 0.7 mm
Chip thickness : 400um (typ.)

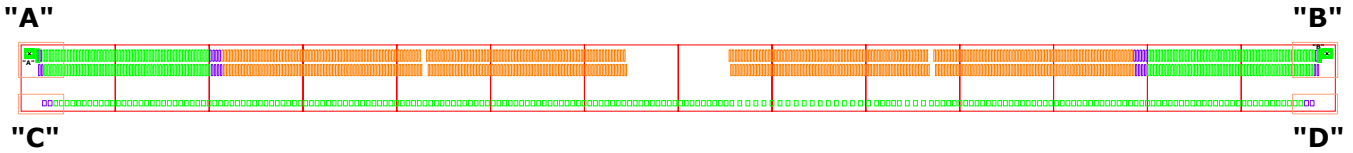

DETAIL "A"

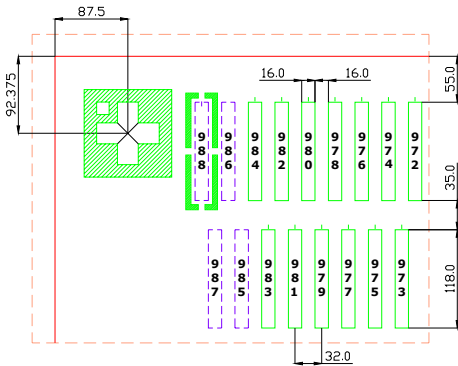

DETAIL "B"

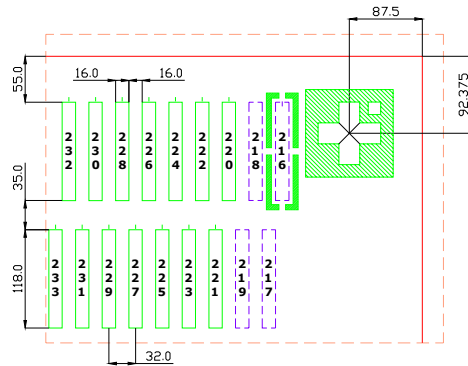

Mark "A"

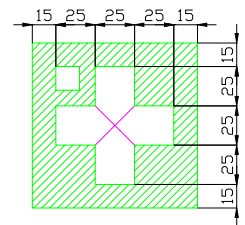

Mark "B"

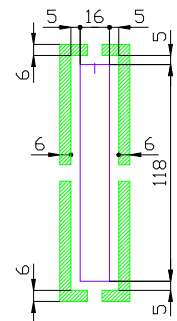

scale : X 10

DETAIL "C"

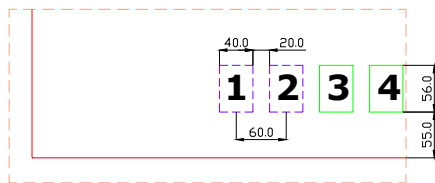

DETAIL "D"

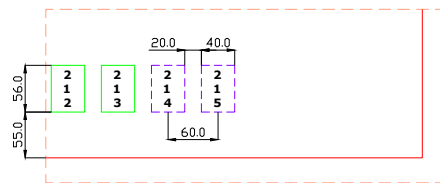

Null PAD



No. 1,2,214,215,216,217,
218,219,330~338,
867~874,985~988



PRODUCT GROUP

REV

ISSUE DATE

TFT PRODUCTS

O

2007.11.16

6.2 Gate/Data IC PAD (S6D0164)

*unit : um

Use ILI9225 & S6D0164 in common

* Chip size : 13.88 X 0.82 mm
Chip thickness : 400um (typ.)

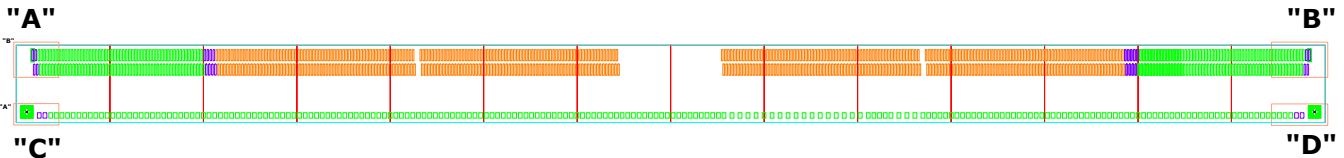

DETAIL "A"

DETAIL "B"

Mark "A"

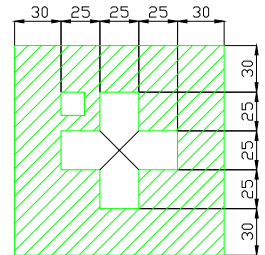
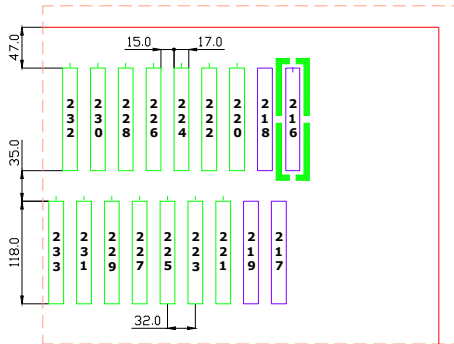
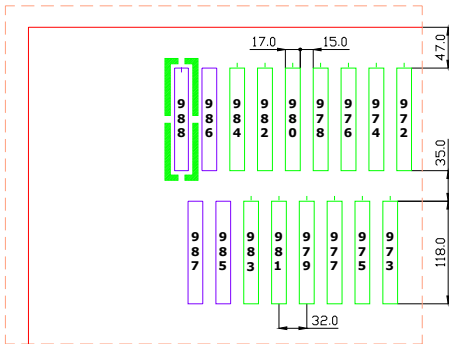

DETAIL "C"

DETAIL "D"

Mark "B"

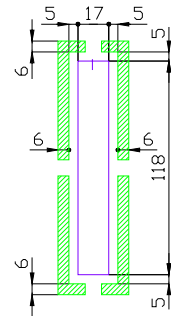
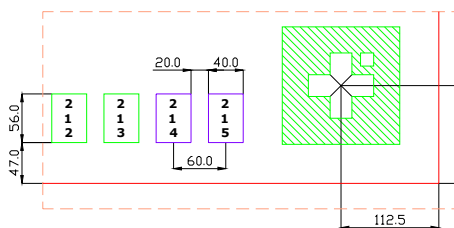
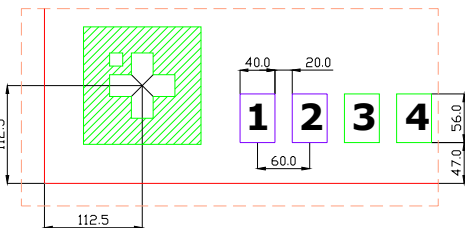

Null PAD

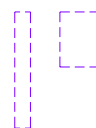

No. 1,2,214,215,216,217,
218,219,330~338,
867~874,985~988



PRODUCT GROUP

REV

ISSUE DATE

TFT PRODUCTS

O

2007.11.16

6.3 FPC Pin Assignment.

*unit : mm

FPC DETAIL

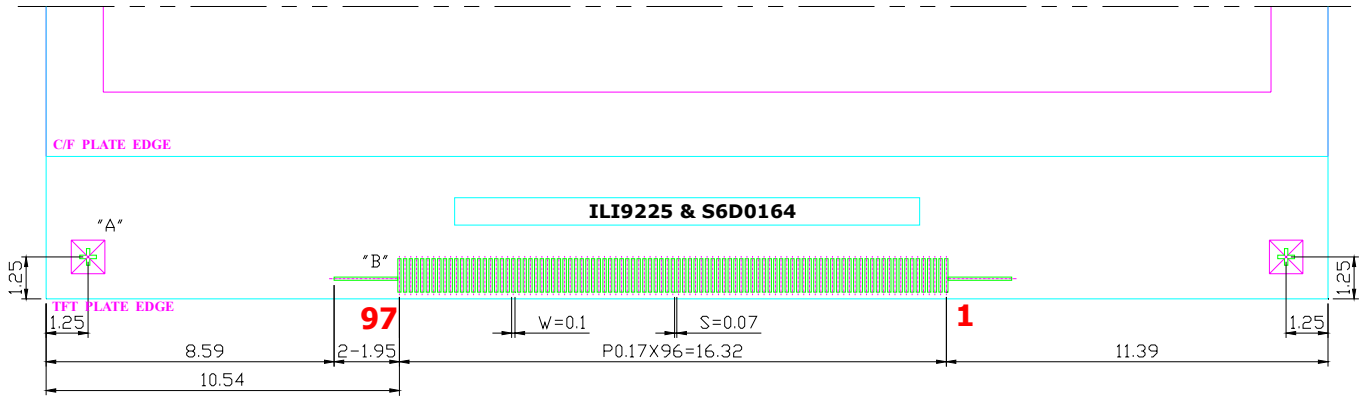

Detail "A"

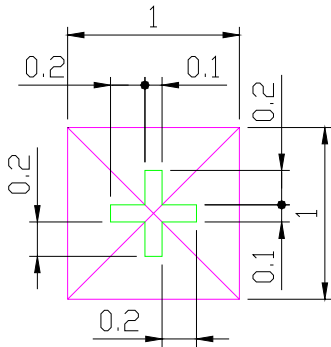

Detail "B"

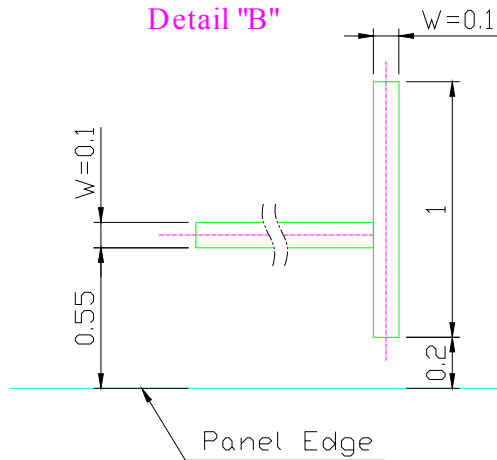



PRODUCT GROUP

REV

ISSUE DATE

TFT PRODUCTS

O

2007.11.16

PIN Name	Pin #	PIN Name	Pin #
Dummy	1	DB<7>	51
NO METAL	2	DB<6>	52
VCOM	3	DB<5>	53
VGL	4	DB<4>	54
GND	5	DB<3>	55
VGL	6	DB<2>	56
VCOM	7~8	DB<1>	57
VGH	9~10	DB<0>	58
VGL	11~12	IM<3>	59
C22P	13	IM<2>	60
C22M	14	IM<1>	61
C21P	15	IM<0>	62
C21M	16	SDO	63
VSSC	17	M	64
VCI1	18	FLM	65
C11P	19	CL1	66
C11M	20	TEST_MODE<2>	67
C12P	21	TEST_MODE<1>	68
C12M	22	TEST_MODE<0>	69
C31P	23	TEST_MUX<2>	70
C31M	24	TEST_MUX<1>	71
AVDD	25~26	TEST_MUX<0>	72
VCI	27~28	TEST_DA	73
VCL	29~30	EN_EXCLK	74
RS	31	EXCLK	75
CSB	32	AVSS	76~78
VSYNC	33	VSS	79~80
HSYNC	34	VGS	81
DOTCLK	35	RVDD	82
ENABLE	36	VDD	83
RESETB	37	VDD3	84
SDI	38	VREF	85
E_RDB	39	GVDD	86
RW_WRB	40	VCOMH	87
DB<17>	41	VCOML	88
DB<16>	42	VCOMR	89
DB<15>	43	CONTACT	90
DB<14>	44	VCOM	91
DB<13>	45	GND	92
DB<12>	46	GND	93
DB<11>	47	VGL	94
DB<10>	48	VCOM	95
DB<9>	49	NO METAL	96
DB<8>	50	DUMMY	97

SPEC. NUMBER
S863-1066

SPEC. TITLE
HTT22QC2-D00 Product Specification

PAGE
13 OF 23



6.4 Cell Test PAD Assignment.

***unit : mm**

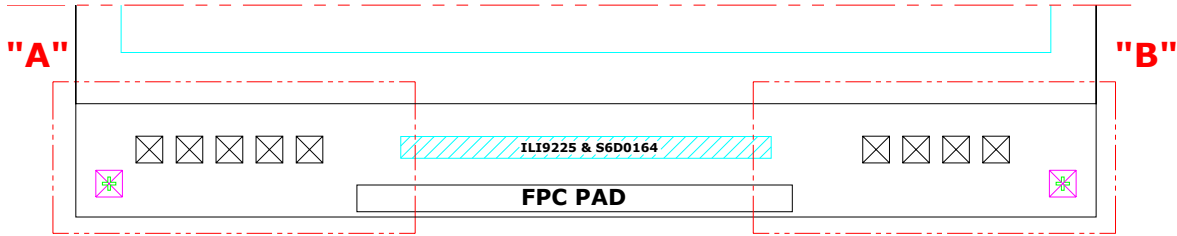

Detail "A"

Detail "B"

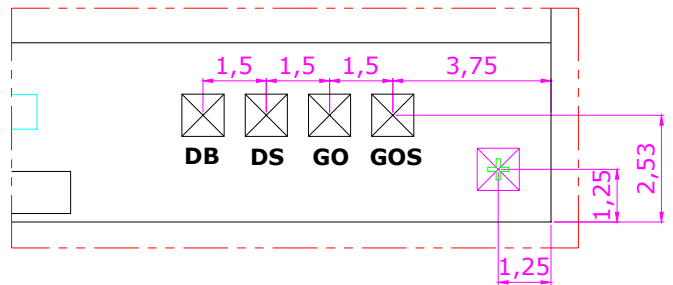
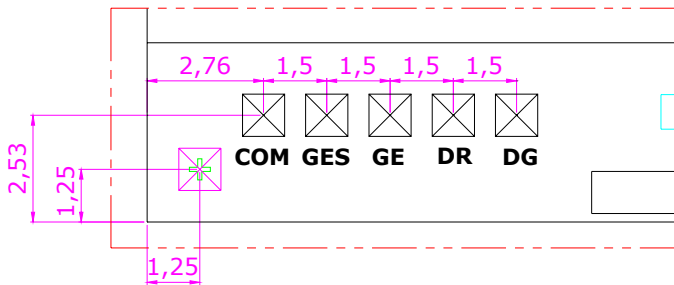



PRODUCT GROUP

REV

ISSUE DATE

TFT PRODUCTS

O

2007.11.16

7.0 RELIABILITY TEST

No	Test Items	Conditions
1	High temperature storage test	Ta = 80 °C, 240 hrs
2	Low temperature storage test	Ta = -30 °C, 240 hrs
3	High temperature operation Test	Ta = 70 °C, 240 hrs
4	Low temperature operation test	Ta = -20 °C, 240 hrs
5	High Temp. and High Humidity Storage	T = 60°C /90% for 240hrs (But no condensation dew)
6	High temperature & high humidity operation test	Ta = 60 °C, 90 %RH, 240 hrs
7	Thermal shock	Ta = -30 °C ↔ 80 °C , 100 cycle
8	Packing Vibration test (non-operating)	Sine : 10~55Hz, Stroke 1.5mm, X,Y,Z 각 2Hrs Random : 1.04GRms, 10~500Hz, X,Y,Z 각 1Hr
9	Packing Drop test (non-operating)	1 Corner, 3 Edge, 6 Faces From 61cm Height
10	Press Cooking Test	2atm, 120°C, 100%, 24h
11	Altitude Test (non – operating)	25°C, 24h, 40000ft
12	Electrostatic discharge test	Air : 150 pF, 330Ω, 8KV 5times/4Corner Contact : 150 pF, 330Ω, 6KV 5times/4Corner



PRODUCT GROUP	REV	ISSUE DATE
	TFT PRODUCTS	O

8.0 HANDLING & CAUTIONS

8.1 Mounting Method

- The panel of the LCD consists of two thin glasses with polarizers which easily get damaged. So extreme care should be taken when handling the LCD.
- Excessive stress or pressure on the glass of the LCD should be avoided. Care must be taken to insure that no torsional or compressive forces are applied to the LCD unit when it is mounted.
- If the customer's set presses the main parts of the LCD, the LCD may show the abnormal display. But this phenomenon does not mean the malfunction of the LCD and should be processed by the way of mutual agreement.
- To determine the optimum mounting angle, refer to the viewing angle range in the specification for each model.
- Mount a LCD module with the specified mounting parts.

8.2 Caution of LCD Handling and Cleaning

- Since the LCD is made of glass, do not apply strong mechanical impact or static load onto it. Handle with care since shock, vibration, and careless handling may seriously affect the product. If it falls from a high place or receives a strong shock, the glass may be broken.
- The polarizers on the surface of the panel are made from organic substances. Be very careful for chemicals not to touch the polarizers or it leads the polarizers to be deteriorated.
- If the use of a chemical is unavoidable, use soft cloth with solvent (recommended below) to clean the LCD's surface and wipe lightly.
 - IPA(Isopropyl Alcohol), Ethyl Alcohol, Trichlorotrifloroethane
- Do not wipe the LCD's surface with dry or hard materials that will damage the polarizers and others. Do not use the following solvent.
 - Water, Ketone, Aromatics
- It is recommended that the LCD be handled with soft gloves during assembly, etc. The polarizers on the LCD's surface are vulnerable to scratches and thus to be damaged by sharp particles.
- Do not drop water or any chemicals onto the LCD's surface.
- A protective film is supplied on the LCD and should be left in place until the LCD is required for operation.
- The ITO pad area needs special careful caution because it could be easily corroded. Do not contact the ITO pad area with HCFC, Soldering flux, Chlorine, Sulfur, saliva or fingerprint. To prevent the ITO corrosion, customers are recommended that the ITO pad area would be covered by UV or silicon.

SPEC. NUMBER S863-1066	SPEC. TITLE HTT22QC2-D00 Product Specification	PAGE 16 OF 23
---------------------------	---	------------------



PRODUCT GROUP

REV

ISSUE DATE

TFT PRODUCTS

O

2007.11.16

8.3 Caution Against Static Charge

- The LCD modules use C-MOS LSI drivers, so customers are recommended that any unused input terminal would be connected to Vdd or Vss, do not input any signals before power is turned on, and ground your body, work/assembly areas, assembly equipment to protect against static electricity.
- Remove the protective film slowly, keeping the removing direction approximate 30-degree not vertical from panel surface, if possible, under ESD control device like ion blower, and the humidity of working room should be kept over 50%RH to reduce the risk of static charge.
- Avoid the use of work clothing made of synthetic fibers. We recommend cotton clothing or other conductivity-treated fibers.
- In handling the LCD, wear non-charged material gloves. And the conducting wrist to the earth and the conducting shoes to the earth are necessary.

8.4 Caution for Operation

- It is indispensable to drive the LCD within the specified voltage limit since the higher voltage than the limit causes the shorter LCD's life. An electro-chemical reaction due to DC causes undesirable deterioration of the LCD so that the use of DC drive should avoid.
- Do not connect or disconnect the LCD to or from the system when power is on.
- Never use the LCD under abnormal conditions of high temperature and high humidity.
- When exposed to drastic fluctuation of temperature (hot to cold or cold to hot), the LCD may be affected; specifically, drastic temperature fluctuation from cold to hot, produces dew on the LCD's surface which may affect the operation of the polarizer and the LCD.
- Response time will be extremely delayed at lower temperature than the operating temperature range and on the other hand at higher temperature LCD may turn black at temperature above its operational range. However those phenomena do not mean malfunction or out of order with the LCD. The LCD will revert to normal operation once the temperature returns to the recommended temperature range for normal operation.
- Do not display the fixed pattern for a long time because it may develop image sticking due to the LCD structure. If the screen is displayed with the fixed pattern, use a screen saver.

8.5 Packaging

- Modules use LCD elements, and must be treated as such.
 - Avoid intense shock and falls from a height.
 - To prevent modules from degradation, do not operate or store them exposed directly to sunshine or high temperature/humidity for long periods.



PRODUCT GROUP

REV

ISSUE DATE

TFT PRODUCTS

O

2007.11.16

8.6 Storage

- A slight dew depositing on terminals is a cause for electro-chemical reaction resulting in terminal open circuit. Relative humidity of the environment should therefore be kept below 60%RH.
- Original protective film should be used on LCD's surface (polarizer). Adhesive type protective film should be avoided, because it may change color and/or properties of the polarizers.
- Do not store the LCD near organic solvents or corrosive gasses.
- Keep the LCD safe from vibration, shock and pressure.
- Black or white air-bubbles may be produced if the LCD is stored for long time in the lower temperature or mechanical shocks are applied onto the LCD.
- In the case of storing for a long period of time for the purpose or replacement use, the following ways are recommended.
 - Store in a polyethylene bag with sealed so as not to enter fresh air outside in it.
 - Store in a dark place where neither exposure to direct sunlight nor light is.
 - Keep temperature in the specified storage temperature range.
 - Store with no touch on polarizer surface by the anything else. If possible, store the LCD in the packaging situation LCD when it was delivered.

8.7 Safety

- For the crash damaged or unnecessary LCD, it is recommended to wash off liquid crystal by either of solvents such as acetone and ethanol and should be burned up later.
- In the case the LCD is broken, watch out whether liquid crystal leaks out or not. If your hands touch the liquid crystal, wash your hands cleanly with water and soap as soon as possible.
- If you should swallow the liquid crystal, first, wash your mouth thoroughly with water, then drink a lot of water and induce vomiting, and then, consult a physician.
- If the liquid crystal should get in your eyes, flush your eyes with running water for at least fifteen minutes.
- If the liquid crystal touches your skin or clothes, remove it and wash the affected part of your skin or clothes with soap and running water.

SPEC. NUMBER
S863-1066

SPEC. TITLE
HTT22QC2-D00 Product Specification

PAGE
18 OF 23



9.0 PACKING SPECIFICATION

BOE Hydis provides the standard shipping container for customers, unless customer specifies their packing information. The standard packing method is shown in below.

Each tray must be loaded with 180° rotation respectively

Vacuum Packing
(Anti Static Packing BAG)

Cushion – 2EA per Inner-Box



9EA Tray (With Cover-Tray)

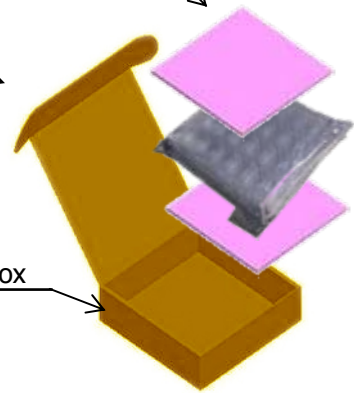

Inner-Box

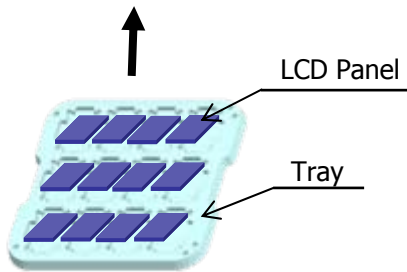

LCD Panel

Tray

20EA Panels per Tray

Box Label

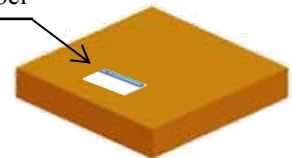

160EA Panels per Inner-Box

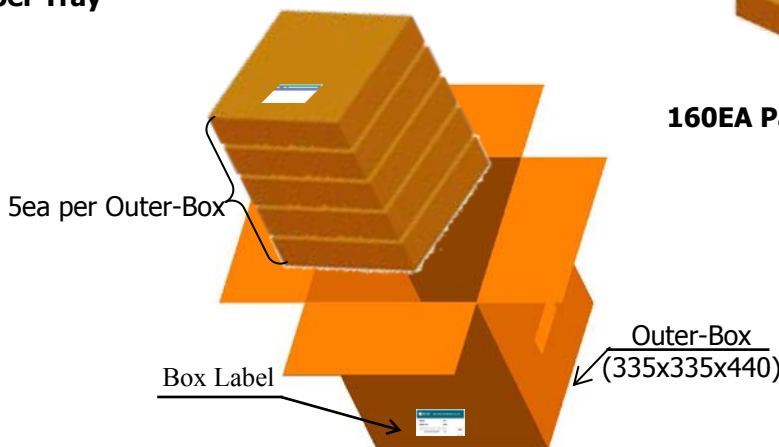

5ea per Outer-Box

Box Label

Outer-Box
(335x335x440)

800EA LCD Panels Per Outer-Box



PRODUCT GROUP

REV

ISSUE DATE

TFT PRODUCTS

O

2007.11.16

10.0 LABEL MARKING

The box label followed by is affixed to a shipped product at the specified location on each packing box.

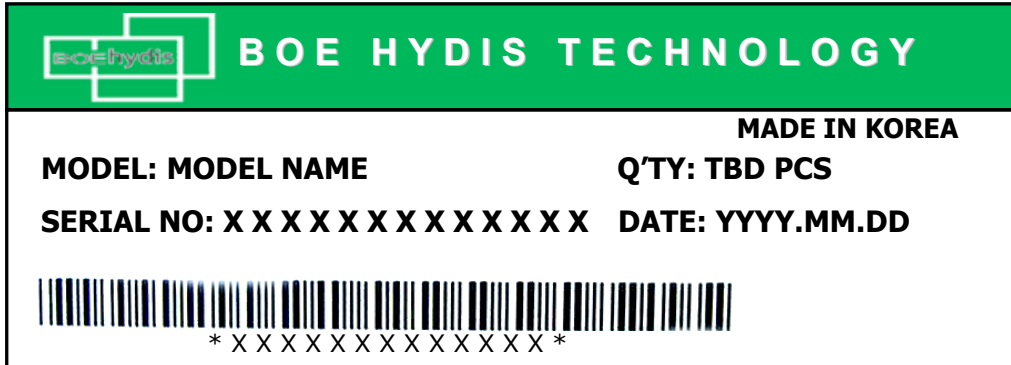

- Outward form : Width 110±0.5mm, Length 55±0.5mm
- Comment column

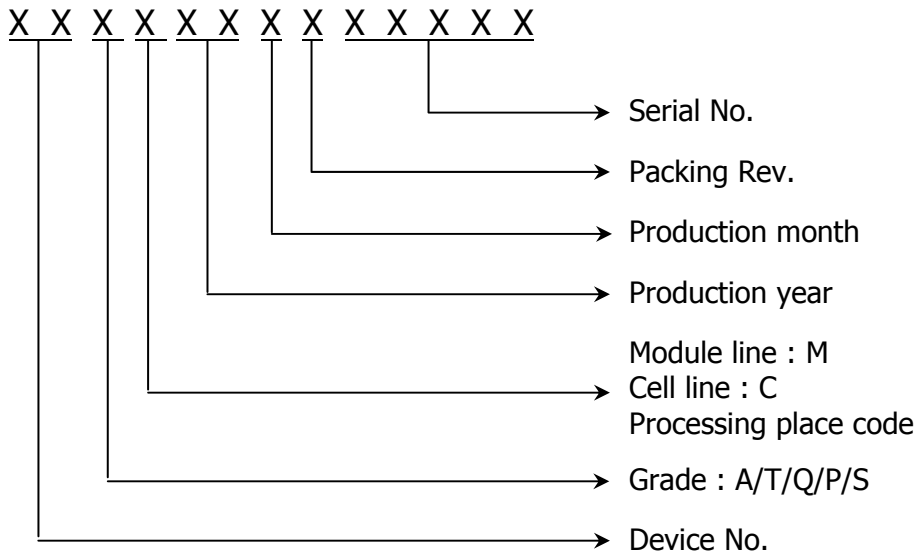



11.0 APPENDIX

Figure 1. The definition of Vth & Vsat

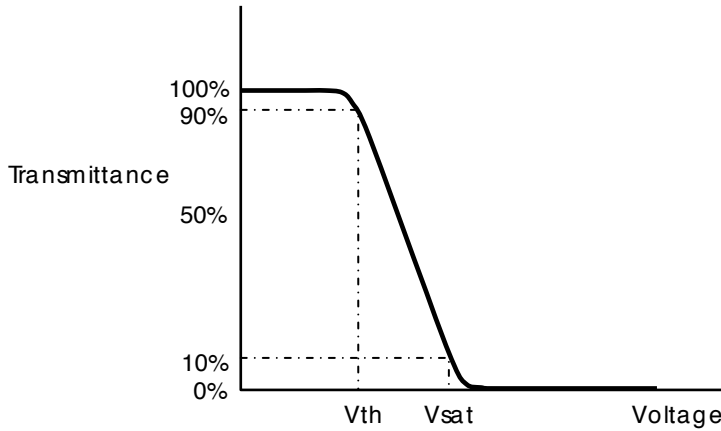

Figure 2. Measurement Set Up

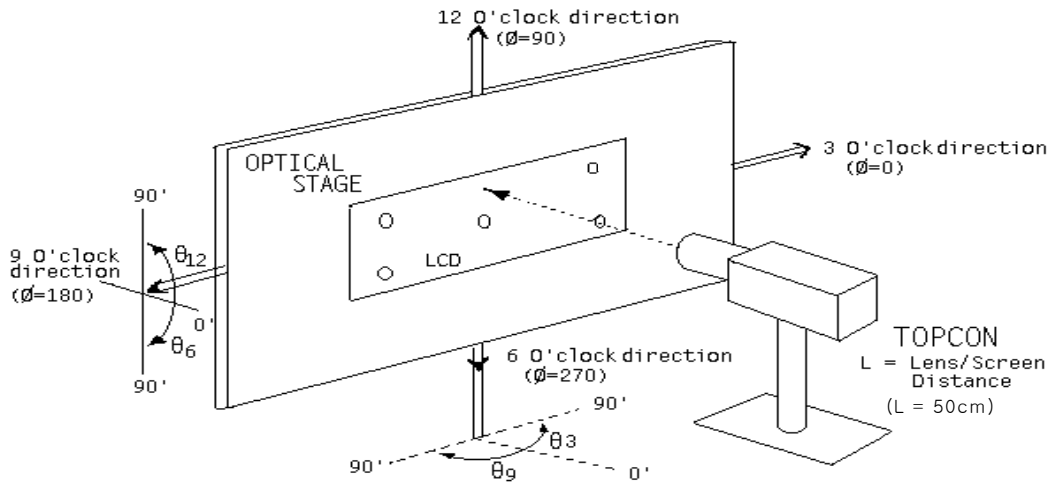



Figure 3. Response Time Testing

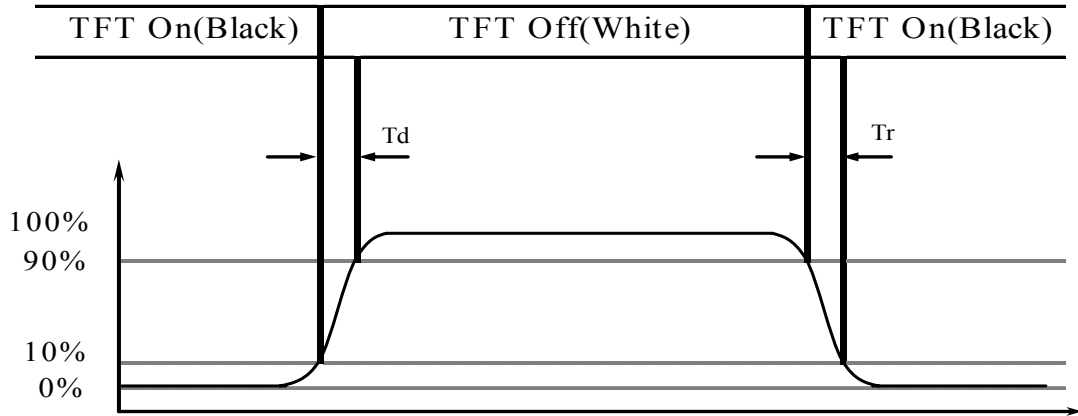
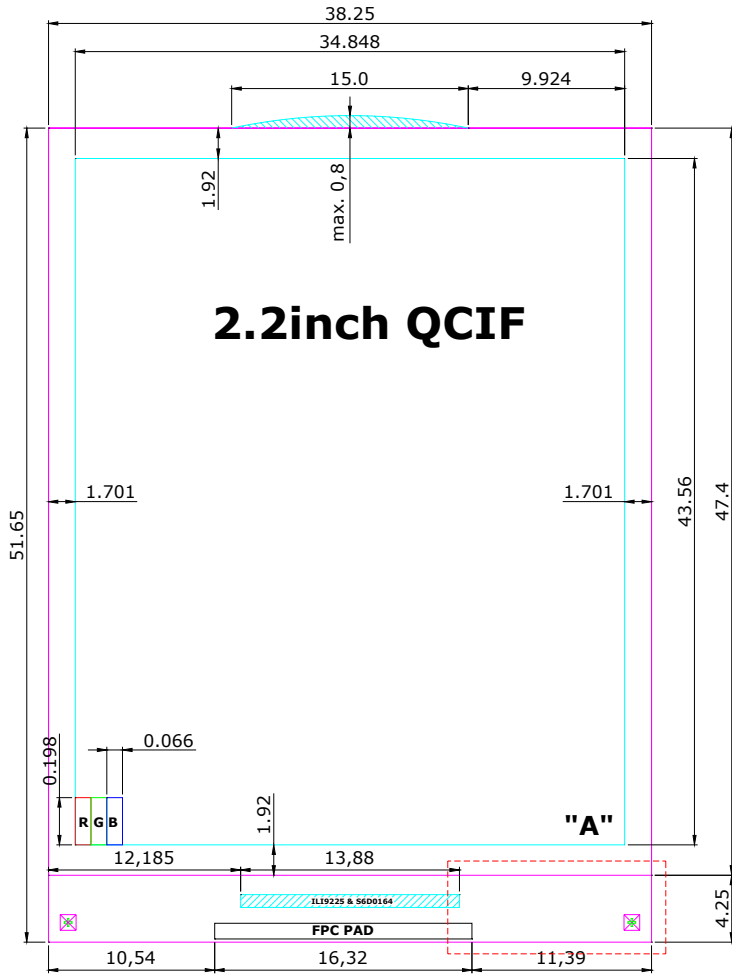



Figure 4. TFT-LCD Panel Outline Dimension

*unit : mm



Detail "A"

