

# **INNOLUX DISPLAY CORPORATION**

## **LCD MODULE**

# **SPECIFICATION**

**Customer:** \_\_\_\_\_  
**Model Name:** AT070TN84  
**SPEC NO.:** A070-84-TT-02  
**Date:** 2008/03/07  
**Version:** 02

- Preliminary Specification  
 Final Specification

Remark
<input checked="" type="checkbox"/> Embedded TTL T-con Board with LED Driver
<input checked="" type="checkbox"/> Touch Screen Panel

### For Customer's Acceptance

Approved by	Comment

Approved by	Reviewed by	Prepared by
<b>Joe Lin</b>  2008/03/31	<b>James Yu</b>  2008/03/31	<b>Kevin Chen</b>  2008/03/31

### Record of Revision

Version	Revise Date	Page	Content
Final-spec.01	2007/05/11	1	Modify backlight power consumption from “1.728W” to “2.500W”.
			Modify panel power consumption from “0.990W” to “0.825W”.
		4	Modify the ADJ frequency from “100-300Hz” to “100-1000Hz”.
			Modify the Typ.value of I <sub>cc</sub> from “300mA” to “250mA” and the Max.value from “350mA” to “300mA”.
		7	Modify “I <sub>L</sub> ” to “I <sub>LED</sub> ” and the Typ.value from “180mA” to “500mA”.
			Add the Max.value of I <sub>LED</sub> .
			Add Note2,Note3.
			Modify Note 5.
		15	Modify test condition 1.
		17	Modify Note 6.
19	Modify Electro Static Discharge test condition.		
23	Modify Packaging Drawing.		
02	2008/03/07	2	Modify TTL connector model from”FH19SC-40S-0.5SH” to “ FH33-40S-0.5SH(10)”.
		4	Modify the ADJ frequency from “100-1000Hz” to “100-300Hz”.
		9	Modify Timing Conditions of SYNC mode.
		10	Modify Timing Conditions of DE mode.
		15	Add section 4.3.
		16	Add section 4.4.
		21	Modify reliability test temperature.
		23	Modify Mechanical Drawing.

**Contents**

1. General Specifications .....	1
2. Pin Assignment.....	2
2.1. TFT LCD Panel Driving Section .....	2
2.2. Touch Screen Panel Section.....	5
3. Operation Specifications .....	6
3.1. Absolute Maximum Ratings .....	6
3.2. Typical Operation Conditions.....	7
3.3. Power Sequence .....	8
3.4. Timing Characteristics .....	9
3.4.1. Timing Conditions.....	9
3.4.2. Timing Diagram .....	11
4. Touch Screen Panel Specifications.....	13
4.1. Electrical Characteristics .....	13
4.2. Mechanical & Reliability Characteristics .....	14
4.3. Linearity Definition .....	15
4.4. Housing Design Guide.....	16
5. Optical Specifications.....	17
6. Reliability Test Items .....	21
7. General Precautions .....	22
7.1. Safety .....	22
7.2. Handling .....	22
7.3. Static Electricity .....	22
7.4. Storage .....	22
7.5. Cleaning .....	22
8. Mechanical Drawing .....	23
9. Package Drawing .....	24
9.1. Packaging Material Table.....	24
9.2. Packaging Quantity .....	24
9.3. Packaging Drawing.....	25

# 1. General Specifications

No.	Item	Specification	Remark
1	LCD size	7.0 inch(Diagonal)	
2	Driver element	a-Si TFT active matrix	
3	Resolution	800X3(RGB)X480	
4	Display mode	Normally white, Transmissive	
5	Dot pitch	0.0635(W)X0.1905(H) mm	
6	Active area	152.4 (W)X91.44 (H) mm	
7	Module size	165(W)X104(H)X6.5(D) mm	Note 1
8	Surface treatment	Anti-Glare	
9	Color arrangement	RGB-stripe	
10	Interface	Digital(TTL)	
11	Backlight power consumption	2.500W (Typ.)	Note 2
12	Panel power consumption	0.825W (Typ.)	Note 3
13	Weight	160g (Typ.)	

Note 1: Refer to Mechanical Drawing.

Note 2: Including LED Driver power consumption.

Note 3: Including T-con Board power consumption.

## 2. Pin Assignment

### 2.1. TFT LCD Panel Driving Section

TTL Connector is used for the module electronics interface. The recommended model is “FH33-40S-0.5SH(10)”, manufactured by Hirose.

Pin No.	Symbol	I/O	Function	Remark
1	V <sub>LED</sub>	P	Power for LED driver	
2	V <sub>LED</sub>	P	Power for LED driver	
3	ADJ	I	Adjust the LED brightness with PWM Pulse	Note1,2
4	G <sub>LED</sub>	P	Ground for LED driver	
5	G <sub>LED</sub>	P	Ground for LED driver	
6	V <sub>CC</sub>	P	Power for digital circuit	
7	V <sub>CC</sub>	P	Power for digital circuit	
8	MODE	I	DE or HV mode control	Note 3
9	DE	I	Data enable	
10	VS	I	Vsync signal input	
11	HS	I	Hsync signal input	
12	GND	P	Power ground	
13	B5	I	Blue data input (MSB)	
14	B4	I	Blue data input	
15	B3	I	Blue data input	
16	GND	P	Power ground	
17	B2	I	Blue data input	
18	B1	I	Blue data input	
19	B0	I	Blue data input(LSB)	
20	GND	P	Power ground	
21	G5	I	Green data input(MSB)	
22	G4	I	Green data input	
23	G3	I	Green data input	
24	GND	P	Power ground	
25	G2	I	Green data input	
26	G1	I	Green data input	

27	G0	I	Green data input(LSB)	
28	GND	P	Power ground	
29	R5	I	Red data input(MSB)	
30	R4	I	Red data input	
31	R3	I	Red data input	
32	GND	P	Power ground	
33	R2	I	Red data input	
34	R1	I	Red data input	
35	R0	I	Red data input(LSB)	
36	GND	P	Power ground	
37	DCLK	I	Sample clock	
38	GND	P	Power ground	
39	L/R	I	Select left or right scanning direction	Note 4,5
40	U/D	I	Select up or down scanning direction	Note 4,5

I: input, O: output, P: Power

Note1: Pin.3 is used to adjust brightness.

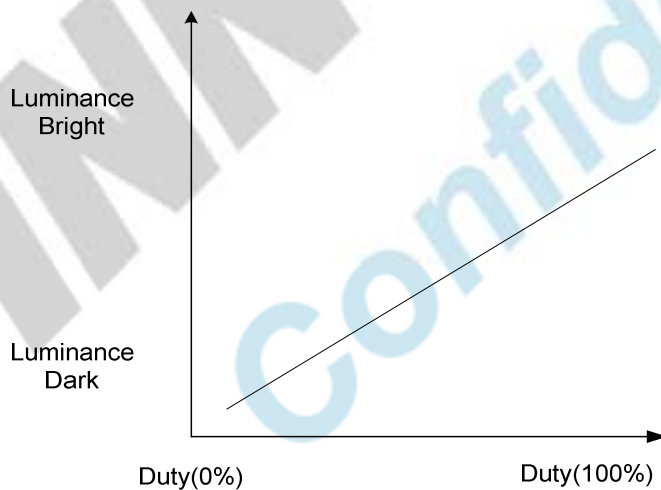

Note 2: ADJ signal=0~3.3V, Operating frequency:100~300Hz.

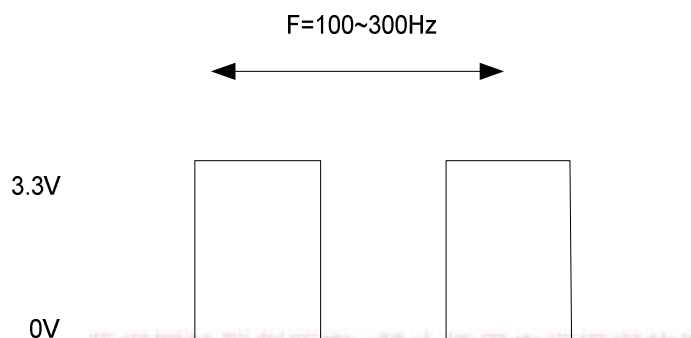

Note 3: DE Mode: Mode="H",HS floating and VS floating;  
 HV Mode: Mode="L" and DE floating.

Note 4: Selection of scanning mode.

Setting of scan control input		Scanning direction
U/D	L/R	
GND	V <sub>CC</sub>	Up to down, left to right
V <sub>CC</sub>	GND	Down to up, right to left
GND	GND	Up to down, right to left
V <sub>CC</sub>	V <sub>CC</sub>	Down to up, left to right

Note 5: Scanning direction refer to the figure below.

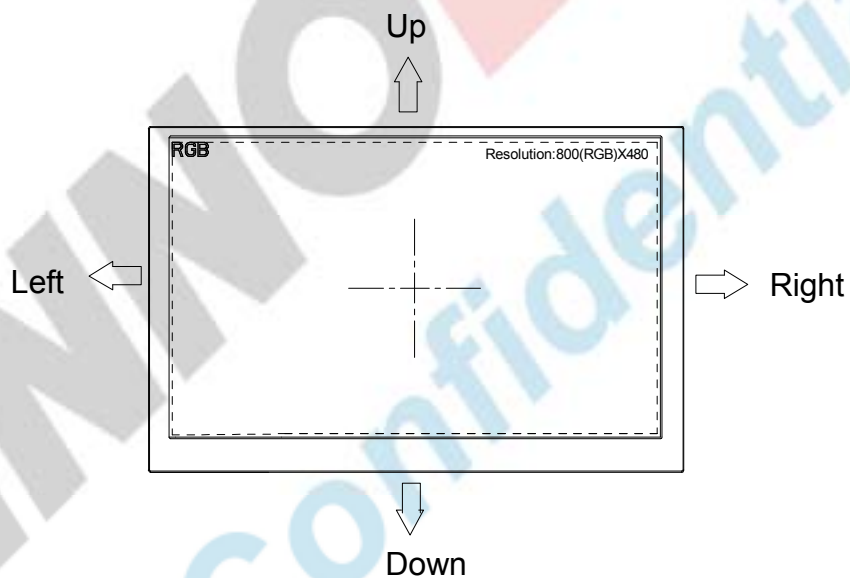

## 2.2. Touch Screen Panel Section

Pin No.	Symbol	I/O	Function	Remark
1	Y2	Top	Top electrode – differential analog	
2	X2	Right	Right electrode – differential analog	
3	Y1	Bottom	Bottom electrode – differential analog	
4	X1	Left	Left electrode – differential analog	

Note: Touch screen panel block

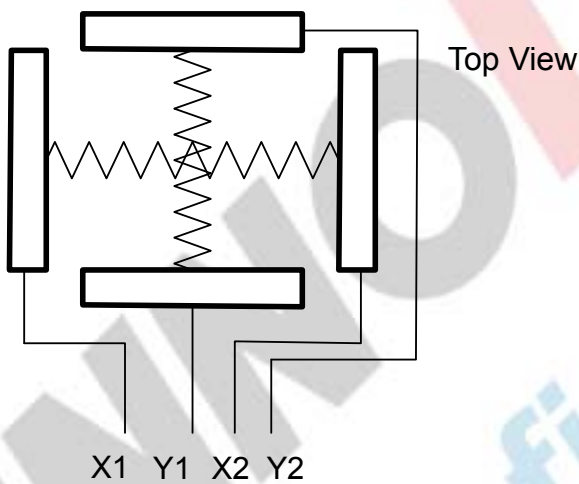



### 3. Operation Specifications

#### 3.1. Absolute Maximum Ratings

(Note1)

Item	Symbol	Values		Unit	Remark
		Min.	Max.		
Power voltage	V <sub>CC</sub>	-0.3	6.0	V	
	V <sub>LED</sub>	-	5.5	V	
Input signal voltage	V <sub>I</sub>	-0.3	6.3	V	
Operation temperature	T <sub>OP</sub>	-10	60	°C	Note 2,3
Storage temperature	T <sub>ST</sub>	-20	70	°C	Note 2,3

Note1: The absolute maximum rating values of this product are not allowed to be exceeded at any times. A module should be used with any of the absolute maximum ratings exceeded, the characteristics of the module may not be recovered, or in an extreme condition, the module may be permanently destroyed.

Note2: 90% RH Max. (Max wet temp. is 40°C)

Maximum wet-bulb temperature is at 38°C or less. And No condensation (no drops of dew)

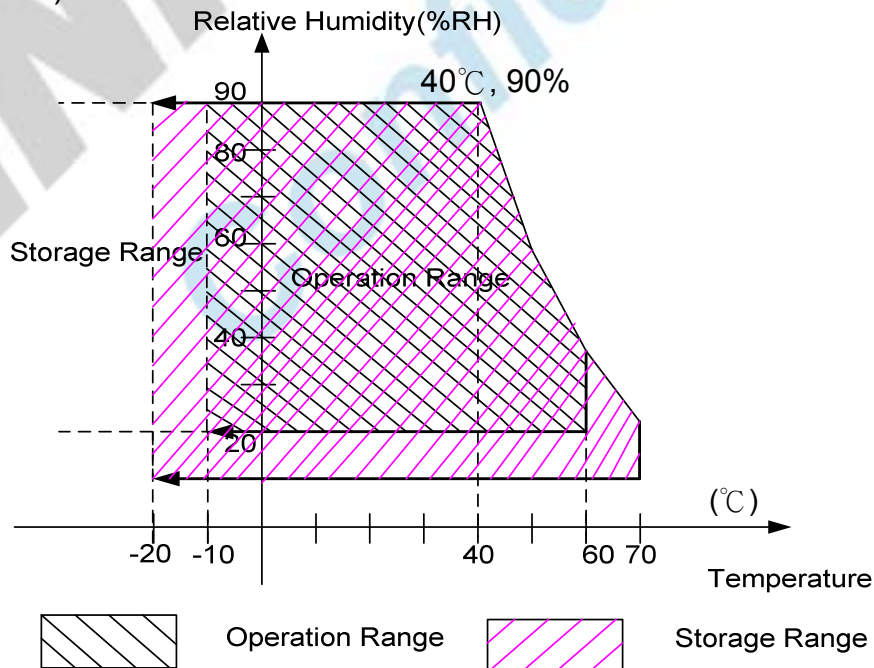

Note3: In case of temperature below 0°C, the response time of liquid crystal (LC) becomes slower and the color of panel darker than normal one.

版權屬於群創所有，禁止任何未經授權的使用

The copyright belongs to InnoLux. Any unauthorized use is prohibited.

### 3.2. Typical Operation Conditions

Item	Symbol	Values			Unit	Remark
		Min.	Typ.	Max.		
Power voltage	$V_{CC}$	3.1	3.3	3.5	V	Note 1
	$V_{LED}$	4.8	5.0	5.2	V	Note 2
Current consumption	$I_{CC}$	-	250	300	mA	
	$I_{LED}$	-	500	550	mA	Note 3
Input logic high voltage	$V_{IH}$	$0.7V_{CC}$	-	$V_{CC}$	V	Note 4
Input logic low voltage	$V_{IL}$	0	-	$0.3V_{CC}$	V	
LED life time	-	20,000	-	-	Hr	Note 5

Note 1:  $V_{CC}$  setting should match the signals output voltage (refer to Note 4) of customer's system board.

Note 2: LED driving voltage.

Note 3: LED driving current.

Note 4: DCLK,DE,HS,VS,R0~ R5,G0~ G5,B0~ B5.

Note 5: The "LED life time" is defined as the module brightness decrease to 50% original brightness at  $T_a=25^{\circ}C$  and  $V_{LED}=5.0V$ . The LED lifetime could be decreased if operating  $V_{LED}$  is larger than 5.0V.

### 3.3. Power Sequence

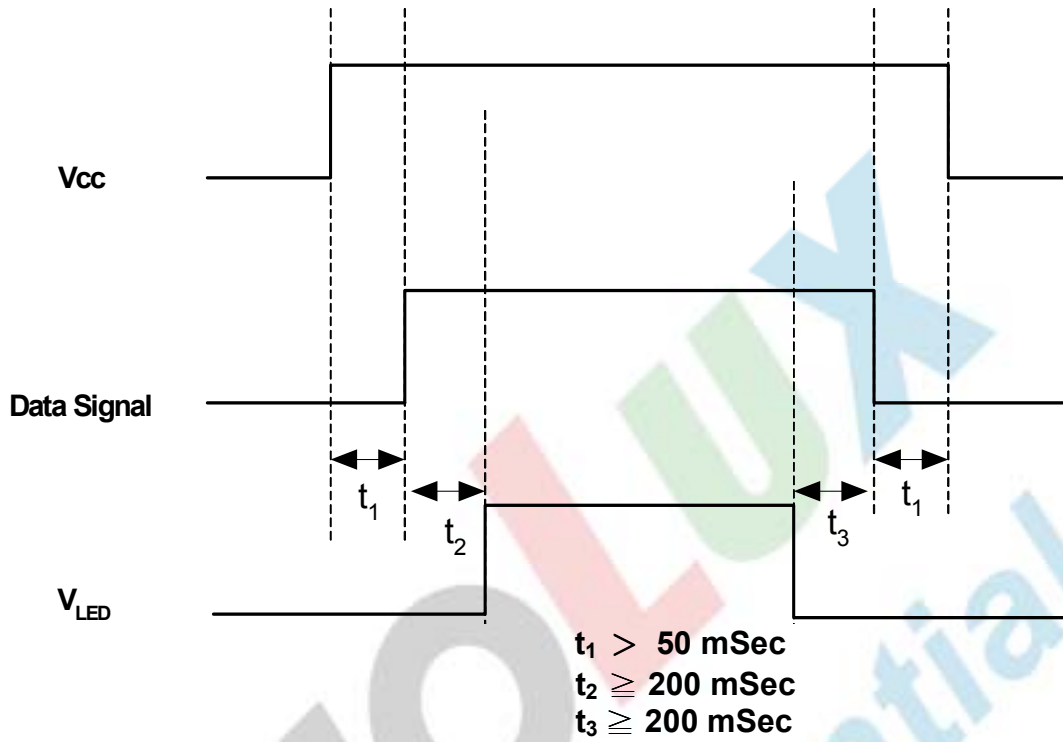

Note: Data Signal includes DCLK, DE, HS, VS, R0~ R5, G0~ G5, B0~ B5.

### 3.4. Timing Characteristics

#### 3.4.1. Timing Conditions

Input signal characteristics of SYNC mode.

Item	Symbol	Values			Unit	Remark
		Min.	Typ.	Max.		
Clock Period	t <sub>CLK</sub>	23.2	25.0	30.7	ns	
Clock Frequency	f <sub>CLK</sub>	32.4	40	43	MHz	
Clock Low Level Width	t <sub>WCL</sub>	8	-	-	ns	
Clock High Level Width	t <sub>WCH</sub>	8	-	-		
Clock Rise/Fall Time	t <sub>CLKr</sub> , t <sub>CLKf</sub>	-	-	3		
HSYNC Period	t <sub>HP</sub>	862	1056	1100	t <sub>CLK</sub>	
HSYNC Pulse Width	t <sub>HW</sub>	-	1	-	t <sub>CLK</sub>	
HSYNC Back Porch	t <sub>HBP</sub>	-	45	-	t <sub>CLK</sub>	
HSYNC Width + Back Porch	t <sub>hw</sub> + t <sub>HBP</sub>	46			t <sub>CLK</sub>	
Horizontal valid data width	t <sub>HV</sub>	800			t <sub>CLK</sub>	
HSYNC Front Porch	t <sub>HFP</sub>	t <sub>HP</sub> - t <sub>HW</sub> - t <sub>HBP</sub> - t <sub>HV</sub>			t <sub>CLK</sub>	
Horizontal Blank	t <sub>HBK</sub>	t <sub>HP</sub> - t <sub>HV</sub>			t <sub>CLK</sub>	
VSYNC Period	t <sub>VP</sub>	628	635	650	t <sub>HP</sub>	
VSYNC Pulse Width	t <sub>VW</sub>	-	1	-	t <sub>HP</sub>	
VSYNC Back Porch	t <sub>VBP</sub>	22			t <sub>HP</sub>	
Vertical valid data width	t <sub>v</sub>	480			t <sub>HP</sub>	
Vertical Front Porch	t <sub>VFP</sub>	t <sub>VP</sub> - t <sub>VW</sub> - t <sub>VBP</sub> - t <sub>v</sub>			t <sub>HP</sub>	
Vertical Blank	t <sub>VBK</sub>	t <sub>VP</sub> - t <sub>v</sub>			t <sub>HP</sub>	
Data Setup Time	t <sub>DS</sub>	5	-	-	ns	
Data Hold Time	t <sub>DH</sub>	10	-	-	ns	

版權屬於研創所有, 禁止任何未經授權的使用

Input signal characteristics of DE mode.

Item		Symbol	Values			Unit	Remark
			Min.	Typ.	Max.		
DCLK	Period	t <sub>CLK</sub>	23.2	25.0	30.7	ns	
	Frequency	f <sub>CLK</sub>	32.4	40	43	MHz	
	Low Level Width	t <sub>wCL</sub>	6	-	-	ns	
	High Level Width	t <sub>wCH</sub>	6	-	-		
	Rise/Fall Time	t <sub>CLKr</sub> , t <sub>CLKf</sub>	-	-	3		
	Duty	-	0.45	0.50	0.55	-	t <sub>CLKL</sub> / t <sub>CLK</sub>
DE	Setup Time	t <sub>DES</sub>	5	-	-	ns	
	Hold Time	t <sub>DEH</sub>	10	-	-		
	Rise/Fall Time	t <sub>DEr</sub> , t <sub>DEf</sub>	-	-	16		
	Horizontal Period	t <sub>HP</sub>	862	1056	1100	t <sub>CLK</sub>	
	Horizontal Valid	t <sub>HV</sub>	800				
	Horizontal Blank	t <sub>HBK</sub>	t <sub>HP</sub> - t <sub>HV</sub>				
	Vertical Period	t <sub>VP</sub>	628	635	650	t <sub>HP</sub>	
	Vertical Valid	t <sub>w</sub>	480				
	Vertical Blank	t <sub>VBK</sub>	t <sub>VP</sub> - t <sub>w</sub>				
DATA	Setup Time	t <sub>DS</sub>	5	-	-	ns	
	Hold Time	t <sub>DH</sub>	10	-	-		
	Rise/Fall Time	t <sub>Dr</sub> , t <sub>Df</sub>	-	-	3		

**3.4.2. Timing Diagram**

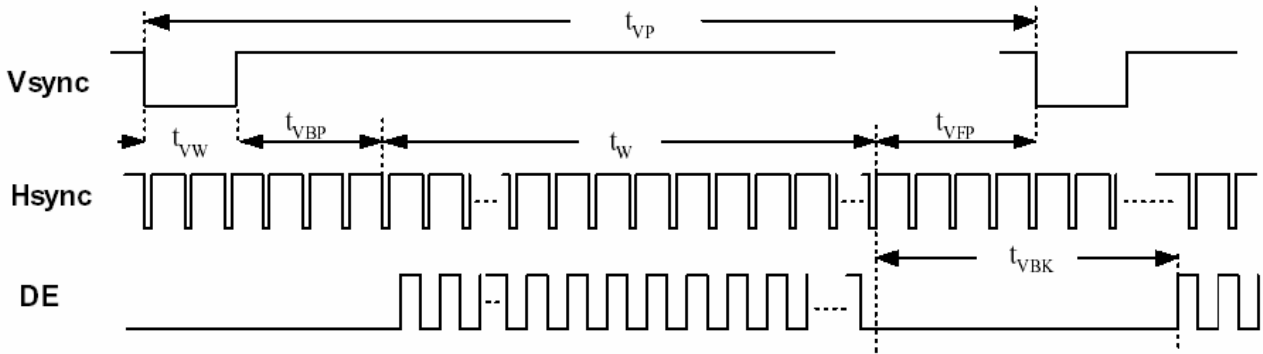

**Input Vertical Timing**

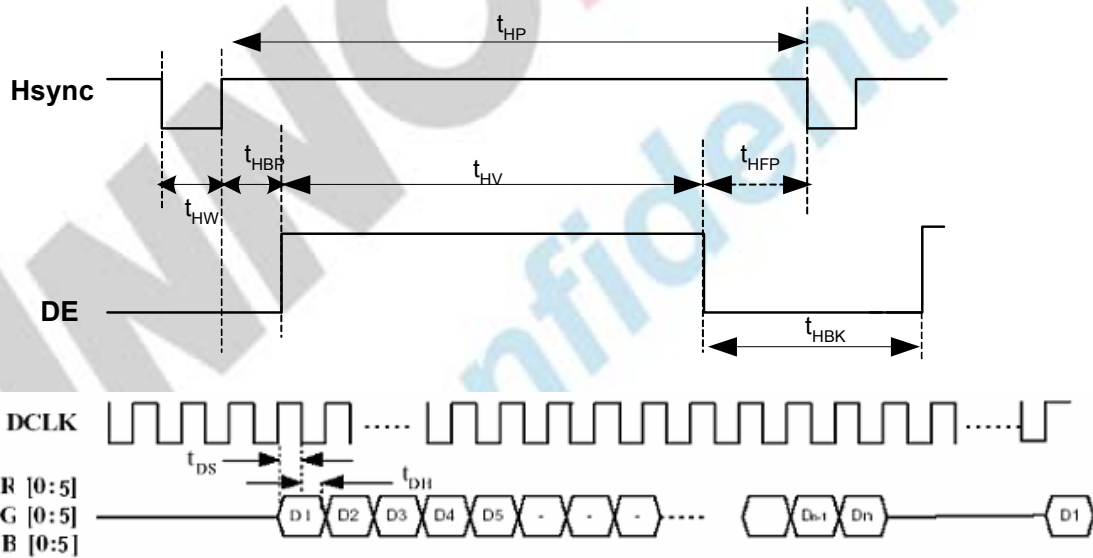

**Input Horizontal Timing**

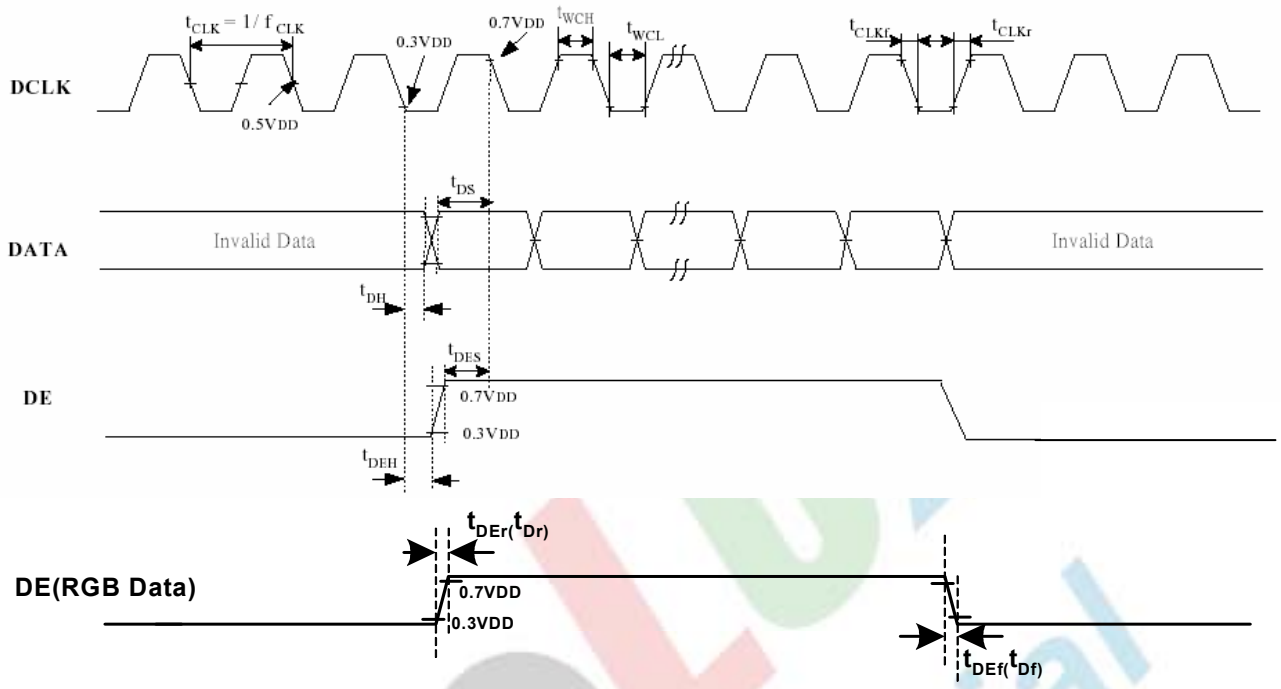

DE and RGB Input Timing

## 4. Touch Screen Panel Specifications

### 4.1. Electrical Characteristics

Item	Value			Unit	Remark
	Min.	Typ.	Max.		
Linearity	-1.5	-	1.5	%	Analog X and Y directions
Terminal Resistance	350	-	1200	$\Omega$	X(Film side)
	100	-	600	$\Omega$	Y(Glass side)
Insulation resistance	25	-	-	M $\Omega$	DC 25V
Voltage	-	-	7	V	DC
Chattering	-	-	10	ms	100k $\Omega$ pull-up
Transparency	80	-	-	%	

Note: Avoid operating with hard or sharp material such as a ball point pen or a mechanical pencil except a polyacetal pen (tip R0.8mm or less) or a finger.



## 4.2. Mechanical & Reliability Characteristics

Item	Value			Unit	Remark
	Min.	Typ.	Max.		
Active force	80	-	-	gf	Note 1
Durability-surface scratching	Write 100,000	-	-	characters	Note 2
Durability-surface pitting	1,000,000	-	-	touches	Note 3
Surface hardness	3	-	-	H	

Note 1: Active force test condition

- (1) Input DC 5V on X direction, Drop off Polyacetal Stylus (R0.8), until output voltage stabilize ,then get the activation force °
- (2) R8.0mm Silicon rubber for finger Activation force test
- (3) Test point: 9 points

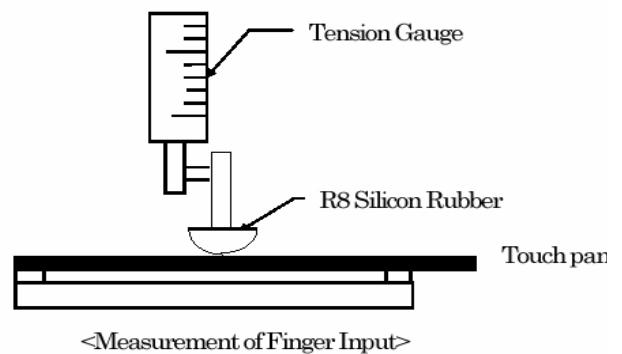
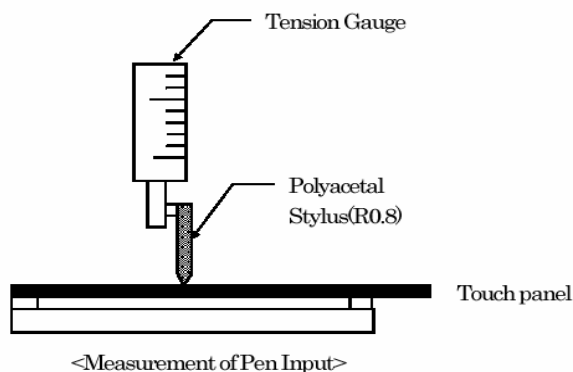

Note 2: Measurement for surface area.

- Scratch 100,000 times straight line on the film with a stylus change every 20,000 times.
- Force: 250gf.
- Speed: 60mm/sec.
- Stylus: R0.8 polyacetal tip.

Note 3: Pit 1,000,000 times on the film with a R0.8 silicon rubber.

- Force: 250gf.
- Speed: 2times/sec.

### 4.3. Linearity Definition

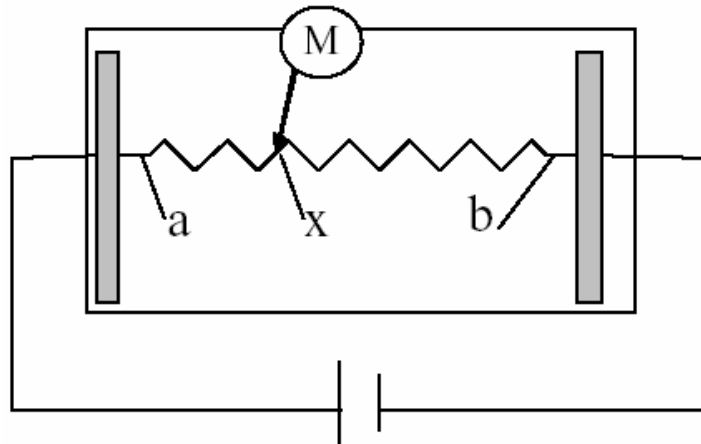

- Va: maximum voltage in the active area of touch panel
- Vb: minimum voltage in the active area of touch panel
- X: random measuring point
- Vxm: actual voltage of Lx point
- Vxi: theoretical voltage of Lx point

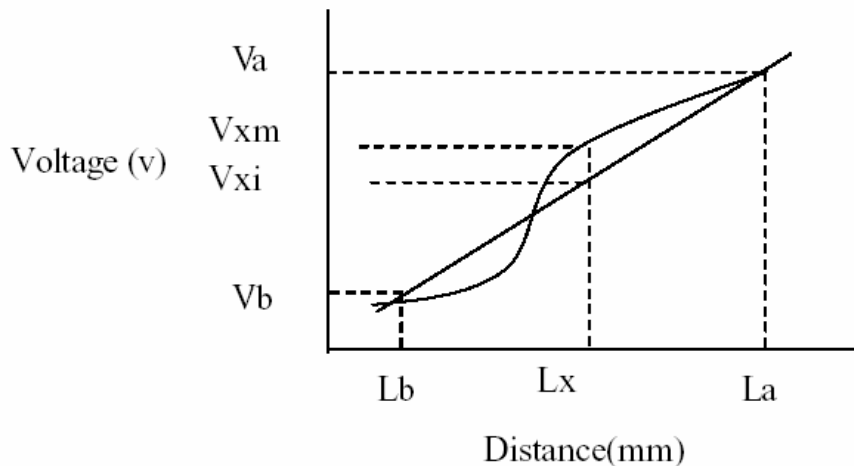

$$\text{Linearity} = \frac{|Vxi - Vxm|}{(Va - Vb)} * 100\%$$

Note: Test area is as follows and operation force is 150gf.

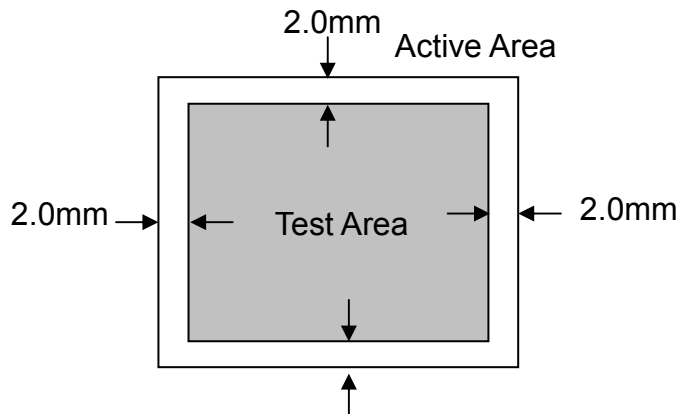

版權屬於群創所 2.0mm 任何未經授權的使用

### 4.4. Housing Design Guide

Housing design follow as below.

- 1) Avoid the design that housing overlap and press on the active area of the LCM.
- 2) Give enough gap(over 0.5mm at compressed) between the housing and TSP to protect wrong operating.

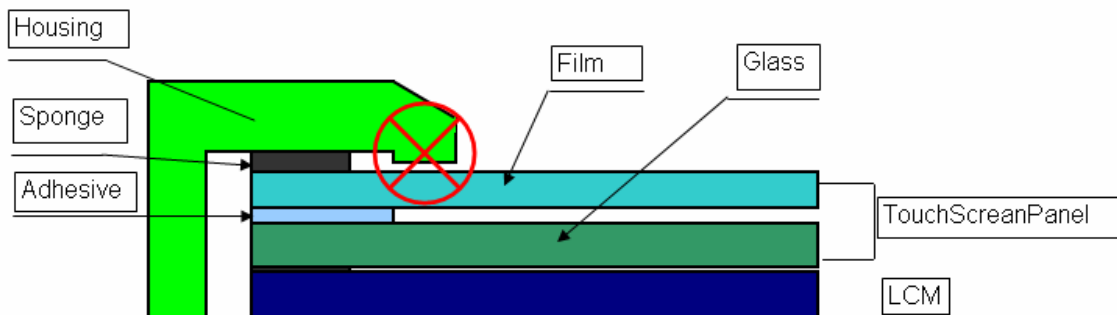

- 3) Use a buffer material(Gasket) between the TSP and housing to protect damage and wrong operating.
- 4) Avoid the design that buffer material overlap and press on the inside of TSP view area.

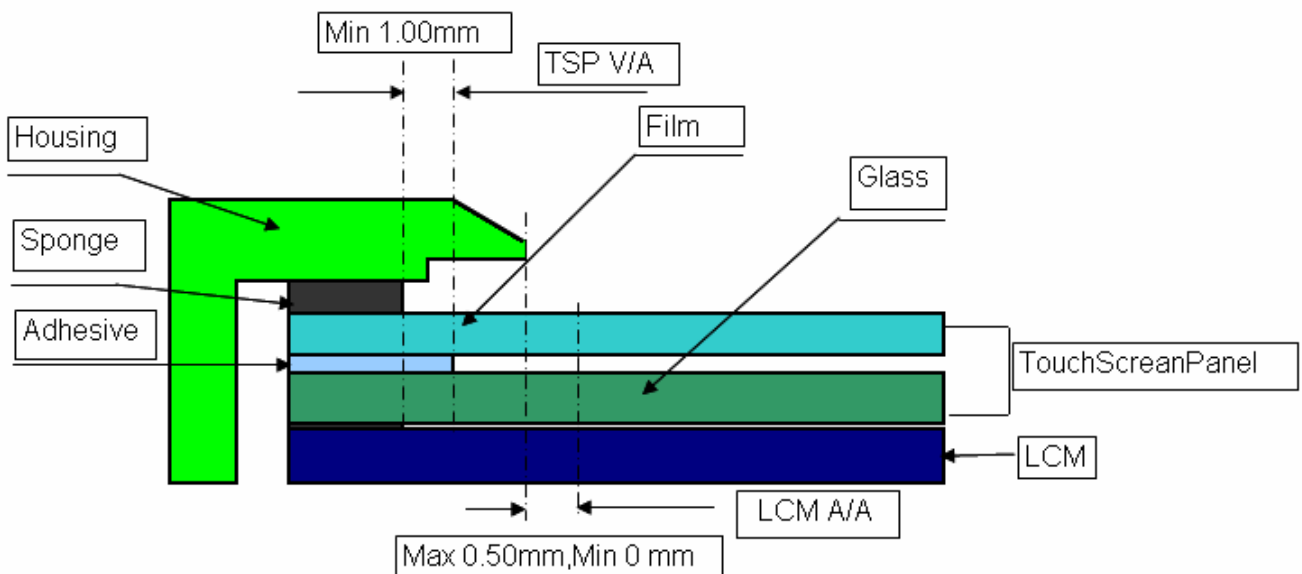

## 5. Optical Specifications

Item	Symbol	Condition	Values			Unit	Remark
			Min.	Typ.	Max.		
Viewing angle (CR≥ 10)	$\theta_L$	$\Phi=180^\circ$ (9 o'clock)	60	70	-	degree	Note 1 Note 7
	$\theta_R$	$\Phi=0^\circ$ (3 o'clock)	60	70	-		
	$\theta_T$	$\Phi=90^\circ$ (12 o'clock)	40	50	-		
	$\theta_B$	$\Phi=270^\circ$ (6 o'clock)	60	70	-		
Response time	$T_{ON}$	Normal $\theta=\Phi=0^\circ$	-	10	20	msec	Note 3
	$T_{OFF}$		-	15	30	msec	Note 3
Contrast ratio	CR		400	500	-	-	Note 4
Color chromaticity	$W_X$		0.26	0.31	0.36	-	Note 2 Note 5
	$W_Y$		0.28	0.33	0.38	-	Note 6 Note 7
Luminance	L		290	360	-	cd/m <sup>2</sup>	Note 6
Luminance uniformity	$Y_U$		70	75	-	%	Note 6 Note 8

**Test Conditions:**

1.  $V_{CC}=3.3V$ ,  $V_{LED}=5.0V$ .The ambient temperature is 25°C.
2. The test systems refer to Note 2.

Note 1: Definition of viewing angle range

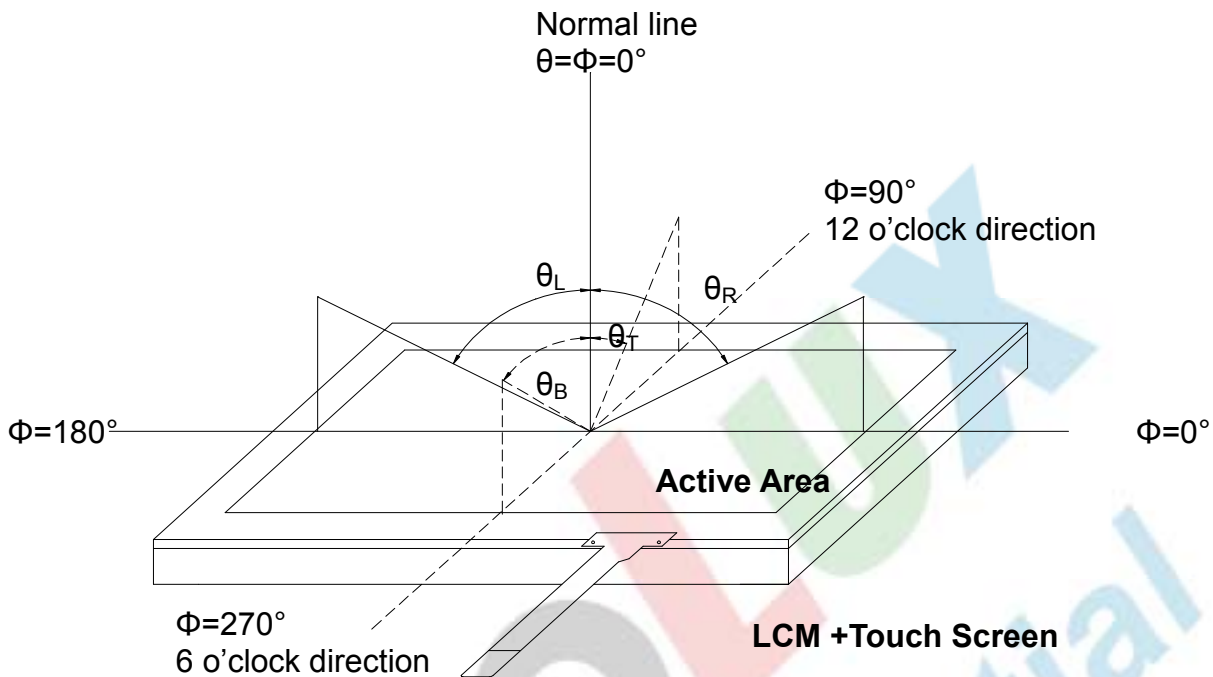

Fig. 4-1 Definition of viewing angle

Note 2: Definition of optical measurement system.

The optical characteristics should be measured in dark room. After 30 minutes operation, the optical properties are measured at the center point of the LCD screen. (Response time is measured by Photo detector TOPCON BM-7, other items are measured by BM-5A/Field of view:  $1^\circ$  /Height: 500mm.)

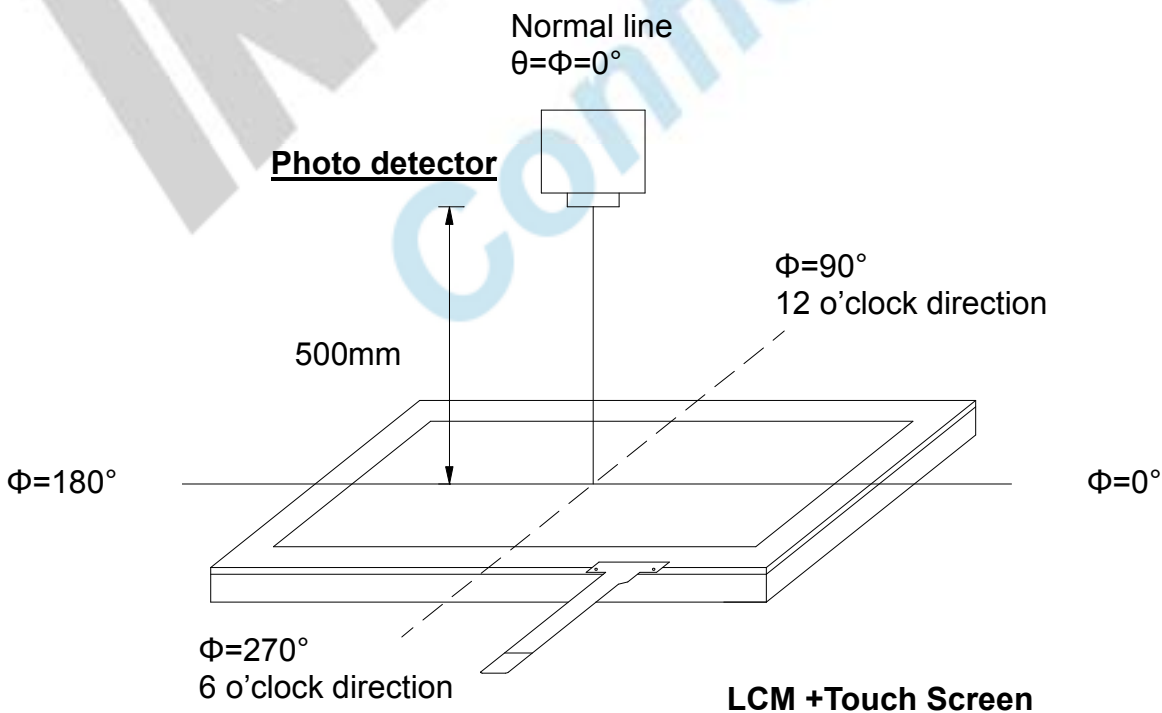

Fig. 4-2 Optical measurement system setup

Note 3: Definition of Response time

The response time is defined as the LCD optical switching time interval between "White" state and "Black" state. Rise time ( $T_{ON}$ ) is the time between photo detector output intensity changed from 90% to 10%. And fall time ( $T_{OFF}$ ) is the time between photo detector output intensity changed from 10% to 90%.

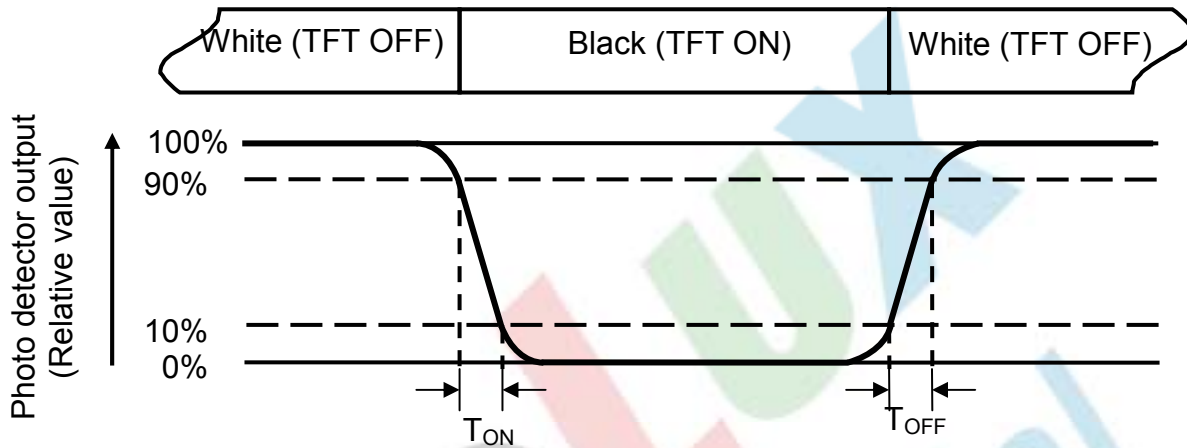

Fig. 4-3 Definition of response time

Note 4: Definition of contrast ratio

$$\text{Contrast ratio (CR)} = \frac{\text{Luminance measured when LCD on the "White" state}}{\text{Luminance measured when LCD on the "Black" state}}$$

Note 5: Definition of color chromaticity (CIE1931)

Color coordinates measured at center point of LCD.

Note 6: All input terminals LCD panel must be ground while measuring the center area of the panel. The LED driving condition is  $V_{LED}=5.0V$ .

Note 7: The values shall be measured without Touch Screen Panel.

Note 8: Definition of Luminance Uniformity

Active area is divided into 9 measuring areas (Refer to Fig. 4-4 ).Every measuring point is placed at the center of each measuring area.

$$\text{Luminance Uniformity (Yu)} = \frac{B_{min}}{B_{max}}$$

L-----Active area length      W----- Active area width

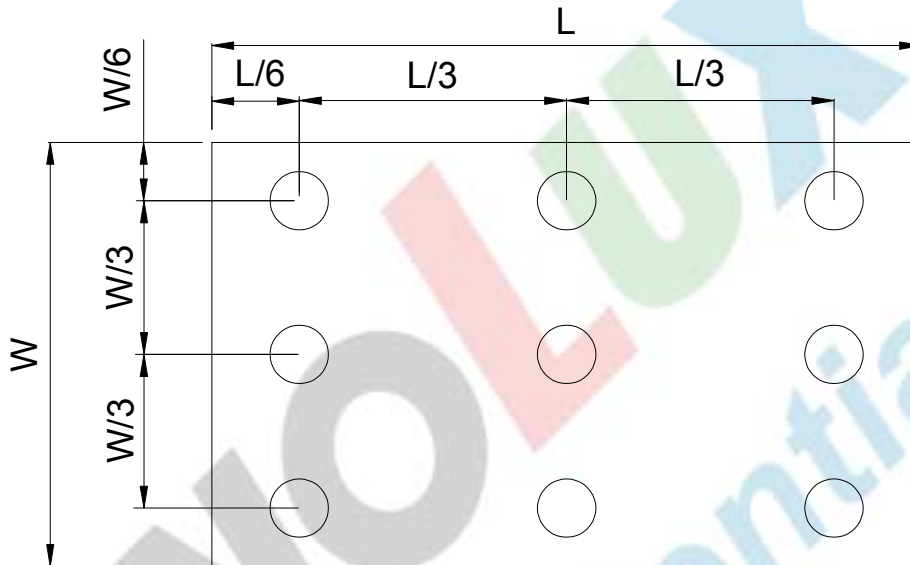

Fig. 4-4 Definition of measuring points

$B_{max}$ : The measured maximum luminance of all measurement position.

$B_{min}$ : The measured minimum luminance of all measurement position.

## 6. Reliability Test Items

(Note 3)

Item	Test Conditions	Remark
High Temperature Storage	Ta = 80°C                      240 hrs	Note 1, Note 4
Low Temperature Storage	Ta = -30°C                      240hrs	Note 1, Note 4
High Temperature Operation	Ts = 70°C                      240hrs	Note 2, Note 4
Low Temperature Operation	Ta = -20°C                      240hrs	Note 1, Note 4
Operate at High Temperature and Humidity	+40°C, 90%RH              240 hrs	Note 5
Thermal Shock	-30°C/30 min ~ +80°C/30 min for a total 100 cycles, Start with cold temperature and end with high temperature	Note 4
Vibration Test	Frequency range:10~55Hz Stroke:1.5mm Sweep:10Hz~55Hz~10Hz 2 hours for each direction of X. Y. Z. (6 hours for total)	
Mechanical Shock	100G 6ms,±X, ±Y, ±Z 3 times for each direction	
Package Vibration Test	Random Vibration : 0.015G*G/Hz from 5-200HZ, -6dB/Octave from 200-500HZ 2 hours for each direction of X. Y. Z. (6 hours for total)	
Package Drop Test	Height:60 cm 1 corner, 3 edges, 6 surfaces	
Electro Static Discharge	±2KV, Human Body Mode, 100PF/1500Ω	

Note 1: Ta is the ambient temperature of samples.

Note 2: Ts is the temperature of panel’s surface.

Note 3: In the standard condition, there shall be no practical problem that may affect the display function. After the reliability test, the product only guarantees operation, but doesn’t guarantee all the cosmetic specification.

Note 4: Before cosmetic and function test, the product must have enough recovery time, at least 2 hours at room temperature.

Note 5: Before cosmetic and function test, the product must have enough recovery time, at least 24 hours at room temperature.

版權屬於群創所有，禁止任何未經授權的使用



## 7. General Precautions

### 7.1. Safety

Liquid crystal is poisonous. Do not put it in your mouth. If liquid crystal touches your skin or clothes, wash it off immediately by using soap and water.

### 7.2. Handling

1. The LCD panel is plate glass. Do not subject the panel to mechanical shock or to excessive force on its surface.
2. The polarizer attached to the display is easily damaged. Please handle it carefully to avoid scratch or other damages.
3. To avoid contamination on the display surface, do not touch the module surface with bare hands.
4. Keep a space so that the LCD panels do not touch other components.
5. Put cover board such as acrylic board on the surface of LCD panel to protect panel from damages.
6. Transparent electrodes may be disconnected if you use the LCD panel under environmental conditions where the condensation of dew occurs.
7. Do not leave module in direct sunlight to avoid malfunction of the lcs.

### 7.3. Static Electricity

1. Be sure to ground module before turning on power or operating module.
2. Do not apply voltage which exceeds the absolute maximum rating value.

### 7.4. Storage

1. Store the module in a dark room where must keep at  $25\pm 10^{\circ}\text{C}$  and 65%RH or less.
2. Do not store the module in surroundings containing organic solvent or corrosive gas.
3. Store the module in an anti-electrostatic container or bag.

### 7.5. Cleaning

1. Do not wipe the polarizer with dry cloth. It might cause scratch.
2. Only use a soft sloth with IPA to wipe the polarizer, other chemicals might permanent damage to the polarizer.

# 8. Mechanical Drawing

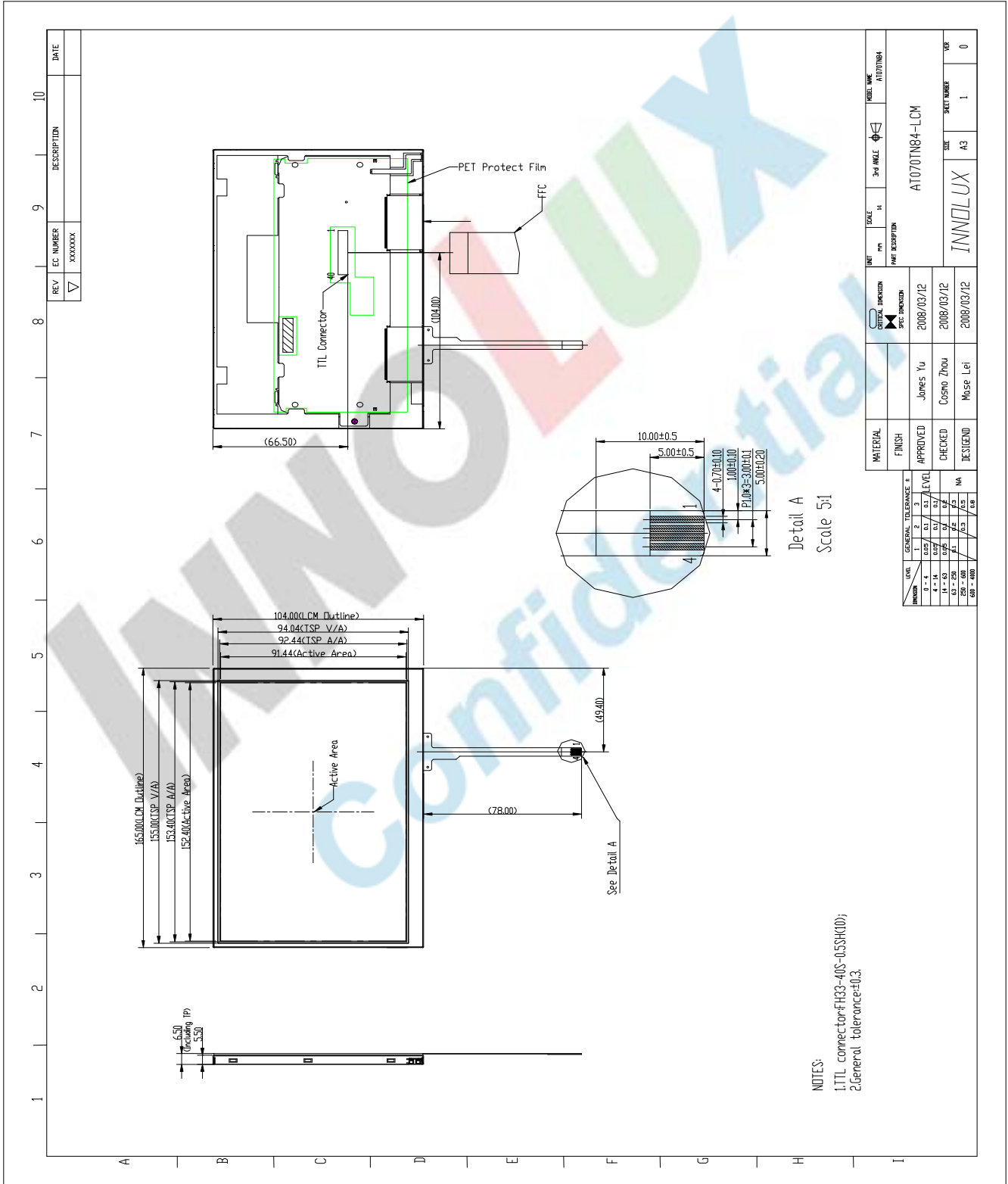

NOTES:  
 1. TTL connector=FH33-40S-055KH(10);  
 2. General tolerance=±0.3.

Detail A  
 Scale 5:1

REV	EC NUMBER	DESCRIPTION	DATE
▽	XXXXXX		

UNIT	SCALE	3rd ANGLE	REEL NO.	A070TN84
MM	1:1			
MATERIAL		PART DESCRIPTION		
FINISH		A070TN84-LCM		
APPROVED	JAMES YU	2008/03/12		
CHECKED	COSMO ZHOU	2008/03/12		
DESIGNED	MUSE LEI	2008/03/12		
GENERAL TOLERANCE		LEVEL		
NUMBER	1	2	3	
0 - 4	±0.25	±0.1	±0.1	
5 - 10	±0.2	±0.1	±0.1	
11 - 20	±0.15	±0.1	±0.1	
21 - 30	±0.1	±0.1	±0.1	
31 - 40	±0.1	±0.1	±0.1	
41 - 50	±0.1	±0.1	±0.1	
51 - 60	±0.1	±0.1	±0.1	
61 - 70	±0.1	±0.1	±0.1	
71 - 80	±0.1	±0.1	±0.1	
81 - 90	±0.1	±0.1	±0.1	
91 - 100	±0.1	±0.1	±0.1	

版權屬於群創所有，禁止任何未經授權的使用

The copyright belongs to InnoLux. Any unauthorized use is prohibited.

## 9. Package Drawing

### 9.1. Packaging Material Table

No.	Item	Model (Material)	Dimensions (mm)	Unit Weight (kg)	Quantity	Remark
1	LCM Module	AT070TN84	165 X 104 X 6.5	0.160	50 pcs	
2	Partition	BC Corrugated Paper	512 X 349 X 226	1.466	1 set	
3	Corrugated Bar	BC Corrugated Paper	512 X 162	0.046	4 set	
4	Corrugated Board	BC Corrugated Paper	510 X 343	0.130	1 pcs	
5	Dust-Proof Bag	PE	700 X 530	0.048	1 pcs	
6	A/S Bag	PE	180 X 160 X 0.05	0.002	50 pcs	
7	Carton	Corrugated paper	530 X 355 X 255	1.100	1 pcs	
8	Total weight	11.028kg±5%				

### 9.2. Packaging Quantity

Total LCM quantity in Carton: no. of Partition	2 Rows	x	quantity per Row	25	= 50
--	--------	---	------------------	----	------

### 9.3. Packaging Drawing

