

SPEC

Spec No.	TQ3C-8EA00-E1BYE03-00
Date	July 01, 2010

TYPE : KTP035BGAB-C00
< Touch panel >

CONTENTS

1. Application
2. Construction and outline
3. Mechanical specifications
4. Absolute maximum ratings
5. Electrical characteristics
6. Interface signals
7. Design guidance for analog touch panel
8. Lot number identification
9. Warranty
10. Precautions for use
11. Reliability test data
12. Outline drawing



KYOCERA CORPORATION
KAGOSHIMA HAYATO PLANT
LCD DIVISION

This specification is subject to change without notice.
Consult Kyocera before ordering.

Original Issue Date	Designed by: Engineering dept.			Confirmed by: QA dept.	
	Prepared	Checked	Approved	Checked	Approved
July 01, 2010	<i>Y. Ikeda</i>	<i>Y. Yamaguchi</i>	<i>M. Fujitani</i>	<i>T. Shikama</i>	<i>To. Itoh</i>

Warning

1. This Kyocera touch panel has been specifically designed for use only in electronic devices and industrial machines in the area of audio control, office automation, industrial control, home appliances, etc. The module should not be used in applications where the highest level of safety and reliability are required and module failure or malfunction of such module results in physical harm or loss of life, as well as enormous damage or loss. Such fields of applications include, without limitation, medical, aerospace, communications infrastructure, atomic energy control. Kyocera expressly disclaims any and all liability resulting in any way to the use of the touch panel in such applications.

2. Customer agrees to indemnify, defend and hold Kyocera harmless from and against any and all actions, claims, damages, liabilities, awards, costs, and expenses, including legal expenses, resulting from or arising out of Customer's use, or sale for use, or Kyocera touch panels in applications.

Caution

1. Kyocera shall have the right, which Customer hereby acknowledges, to immediately scrap or destroy tooling for Kyocera touch panels for which no Purchase Orders have been received from the Customer in a two-year period.

Spec No. TQ3C-8EA00-E1BYE03-00	Part No. KTP035BGAB-C00	Page -
-----------------------------------	----------------------------	-----------

Revision record

Date		Designed by : Engineering dept.			Confirmed by : QA dept.	
		Prepared	Checked	Approved	Checked	Approved
Rev.No.	Date	Page	Descriptions			

1. Application

This document defines the specification of KTP035BGAB-C00. (RoHS Compliant)

2. Construction and outline

Touch panel : Analog type(Glass/Glass)
Surface film : Glare Anti-finger print treatment

3. Mechanical specifications

3-1. Mechanical specifications of touch panel

Item	Specification	Unit
Outline dimensions 1)	76.3(W)×61.6(H)×1.44(D)	mm
Active area	70.7(W)×53.2(H)	mm
Viewing area	71.7(W)×54.2(H)	mm
Mass	TBD	g
Input	Radius-0.8 stylus or Finger	-
Actuation Force	0.1~2.0	N
Operating life	Striking(Finger-input) 2)	TBD hits
	Sliding(Stylus-input) 3)	TBD characters
Transmittance	Typ.80(at full wavelength)	%
Reflectance	Typ.15(550nm)	%
Surface hardness	3H or more(Pencil hardness)	-

1) Please refer to outline drawing for details.

2) Striking test condition

Testing rod : Silicon rubber (Hardness:60°),Tip : R = 4.0,
Testing location : In active area
Input voltage : DC5V
Load : 2.94N
Cycle : 5hits/sec
Judgment : No defect in function
: No appearance defect which causes trouble to use.
*Dents, blurs and marks on surface film : neglected

3) Sliding test condition

Testing rod : Polyacetal resin, Tip : R = 0.8
Testing location : In active area
Input voltage : DC5V
Load : 2.45N
Input length : 10mm
Input speed : 50mm/sec
Sliding times : 10mm sliding (back and forth) counts as 2 times.
Judgment : No defect in function
: No appearance defect which causes trouble to use.
*Dents, blurs and marks on surface film : neglected

4. Absolute maximum ratings

4-1. Electrical absolute maximum ratings

Item	Symbol	Min.	Max.	Unit
Supply voltage for touch panel	V _{TP}	0	6.0	V
Input current of touch panel	I _{TP}	0	0.5	mA

4-2. Environmental absolute maximum ratings

Item	Symbol	Min.	Max.	Unit
Operating temperature	T _{OP}	-30	85	°C
Storage temperature	T _{STO}	-40	95	°C
Operating humidity 1)	H _{OP}	10	2)	%RH
Storage humidity 1)	H _{STO}	10	2)	%RH
Vibration	-	3)	3)	-
Shock	-	4)	4)	-

1) Non-condensing.

2) Temp. ≤ 40°C, 85%RH Max.

Temp. > 40°C, Absolute humidity shall be less than 85%RH at 40°C.

3) The touch panel is installed on the LCD using two sided tape.

Frequency	10~55 Hz	Acceleration value (0.3~9 m/s ²)
Vibration width	0.15mm	
Interval	10-55-10 Hz	1 minutes

2 hours in each direction X, Y, Z (6 hours total)

EIAJ ED-2531

4) The touch panel is installed on the LCD using two sided tape.

Acceleration: 490 m/s², Pulse width: 11 ms

3 times in each direction: ±X, ±Y, ±Z

EIAJ ED-2531

5. Electrical characteristics

Item	Symbol	Condition	Min.	Typ.	Max.	Unit
Supply voltage for touch panel	V _{TP}	-	-	5.0	-	V
Terminal resistance	xL-xR	-	(TBD)	-	(TBD)	Ω
	yU-yL	-	(TBD)	-	(TBD)	Ω
Linearity	2)	-	less than ±2.5			%
Insulation resistance	3)	DC25V	50	-	-	MΩ
Chattering	4)	at ON/OFF	less than 10			ms

- 1) Resistance between terminal xL and xR, or between yU and yL.
- 2) Apply 5VDC to the terminal xL-xR, and measure the output voltage at terminal y when a random input is applied in the active area. Measure the difference between the output and theoretical voltages. (Measure the actual voltage at the terminal using the same method.)

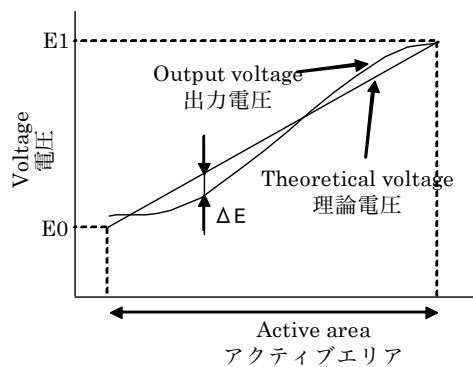

$$\text{Linearity (リニアリティ) (\%)} = \frac{\Delta E_{\text{max}}}{E1 - E0}$$

- 3) Resistance between the upper and lower terminals.
- 4) Apply 5VDC to the terminal xL-xR, and measure the oscillation at terminal y when applying a random input in the active area. (Measure the oscillation at terminal x using the same method.)

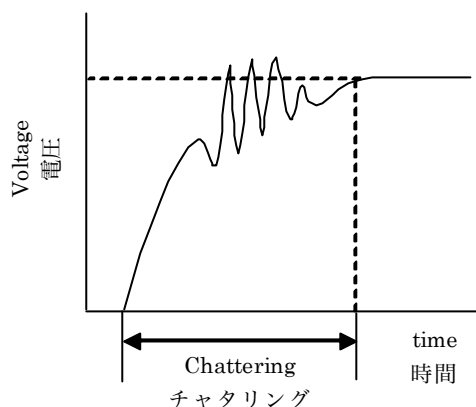

6. Interface signals

No.	Symbol	Description
1	xR	x-Right terminal
2	yL	y-Lower terminal
3	xL	x-Left terminal
4	yU	y-Upper terminal

Touch panel side connector	:	1mm pitch	
Recommended matching connector	:	Series 9616	(IRISO)
	:	Series 9610	(IRISO)
	:	Series FMS	(JST)

7. Design guidance for analog touch panel

7-1 Electrical (In customer's design, please remember the following considerations.)

- 1) Do not use the current regulated circuit.
- 2) Keep the current limit with top and bottom layer. (Please refer to "Electrical absolute maximum ratings" for details.)
- 3) Analog touch panel can not sense two points touching separately.
- 4) A contact resistance is appeared at the touch point between top and bottom layer. After this resistance has stable read of the touch panel position data.
- 5) Because noise of inverter or peripheral circuits may interfere signal of touch panel itself it is necessary to design carefully in advance to avoid these noise problem.

7-2 Software

- 1) Do the "User Calibration".
- 2) "User Calibration" may be needed with long term using. Include "User Calibration" menu in your software.
- 3) When drawing a line with a stylus, there may be a slight discontinuity when the stylus passes over a spacer-dot. If necessary, please provide a compensation feature within your software.

7-3 Mounting on display and housing bezel

- 1) Do not use an adhesive tape to bond it on the front of touch panel and hang it to the housing bezel.
- 2) This touch panel has an airtight but not watertight structure. Please not to use it for the applications requiring watertight or under the environments occurred condensation. If it is expected to be exposed to the environments that vapor, moisture or other liquids may seep inside a bezel, please be sure to take some measurements for drip-proof or waterproof by using sealing materials on the bezel.
- 3) Please mount the touch panel so that it is flat. An optical interference pattern (Newton ring) may be observed if the touch panel is installed on a bent or twisted LCD surface or if it is bent or twisted after installation.
- 4) Please mount the touch panel so that it does not move or slide relative to the LCD, even when vibration or shock is applied and even when high humidity or high temperature may weaken the mounting adhesive.

Spec No. TQ3C-8EA00-E1BYE03-00	Part No. KTP035BGAB-C00	Page 5
-----------------------------------	----------------------------	-----------

8. Lot number identification

The lot number shall be indicated on the FPC tale.

KTP035BGAB-C00 - □□□□□□□□ □□□

↓ ↓
 1 2

No1. – No2. above indicate
 1. Lot No. 9 digits
 2. Serial 3 digits

9. Warranty

9-1. Incoming inspection

Please inspect the touch panel within one month after your receipt.

9-2. Production warranty

Kyocera warrants its touch panel's for a period of 12 months from the ship date. Kyocera shall, by mutual agreement, replace or re-work defective touch panel's that are shown to be Kyocera's responsibility

Spec No. TQ3C-8EA00-E1BYE03-00	Part No. KTP035BGAB-C00	Page 6
-----------------------------------	----------------------------	-----------

10. Precautions for use

10-1. Usage

- 1) **DO NOT** store in a high humidity environment for extended periods. Surface film degradation bubbles, and/or peeling off of the surface film may result.
- 2) Do not push or rub the touch panel's surface with hard to sharp objects such as knives, or the touch panel may be scratched.
- 3) When the touch panel is dirty, gently wipe the surface with a soft cloth, sometimes moistened by mild detergent or alcohol. If a hazardous chemical is dropped on the touch panel by mistake, wipe it off right away to prevent human contact.
- 4) Always keep the touch panel free from condensation during testing. Condensation may permanently spot or stain the surface film.
- 5) Do not pull the touch panel FPC and do not bend the root of the wires. Housing should be designed to protect touch panel FPC from external stress.
- 6) This Kyocera touch panel has been specifically designed for use in general electronic devices, but not for use in a special environment such as usage in an active gas. Hence, when the touch panel is supposed to be used in a special environment, evaluate the touch panel thoroughly beforehand and do not expose the touch panel to chemicals such as an active gas.
- 7) The touch panel is made of glass. It may break when dropped, or vibrated excessively. Usually there is a film on the surface of the glass which would prevent broken glass from scattering, but nevertheless handle it carefully during assembly and treat it gently during use.
- 8) Touch panel edges are sharp, so they have a possibility of cutting your body, for example your finger. Handle the touch panel with enough care to prevent cuts. When you hold the touch panel, put on the protector, for example the gloves which have a strength enough to stand sharpness of touch panel edges.

10-2. Installation of the touch panel

- 1) The touch panel shall be installed flat, without twisting or bending.
- 2) Please design the housing window so that its edges are between the active area and the effective area of the touch screen. Must maintain a gap between inside of bezel and touch panel to avoid malfunction or electrode damage of touch panel.
- 3) A transparent protection sheet is attached to the touch panel. Please remove the protection film slowly before use, paying attention to static electricity.
- 4) Do not scratch, or put any stress outside the active area of the touch panel when you install it on to an LCD, or it may damage the ITO pattern of the touch panel.

10-3. Operation

- 1) The touch panel shall be operated within the limits specified. Operation at values outside of these limits may shorten life, and/or harm display images.
- 2) Do not use the touch panel in environments conducive to the formation of condensation.

10-4. Storage

- 1) The touch panel shall be stored within the temperature and humidity limits specified. Store in a dark area, and protect the touch panel from direct sunlight or fluorescent light.
- 2) Always store the touch panel so that it is free from external pressure onto it. This will prevent the formation of Newton rings.

11. Reliability test data

Test item	Test condition	Test time	Judgement
High temp. atmosphere	95°C	240h	Touch panel function : No defect Terminal resistance : No defect Linearity : No defect Actuation Force : No defect
Low temp. atmosphere	-40°C	240h	Touch panel function : No defect Terminal resistance : No defect Linearity : No defect Actuation Force : No defect
High temp. humidity atmosphere	40°C90% RH	240h	Touch panel function : No defect Terminal resistance : No defect Linearity : No defect Actuation Force : No defect
Temp. cycle	-40°C 0.5h R.T. 0.5h 95°C 0.5h	10cycles	Touch panel function : No defect Terminal resistance : No defect Linearity : No defect Actuation Force : No defect
High temp. operation	85°C	500h	Touch panel function : No defect Terminal resistance : No defect Linearity : No defect Actuation Force : No defect
Point activation	Silicon rubber R4, Hardness 60° Hitting force 2.9N Hitting speed 5 time/s	TBD	Touch panel function : No defect Terminal resistance : No defect Linearity : No defect Actuation Force : No defect No appearance defect which affects touch panel function. 2)
Sliding	Polyacetal resin, Tip : R = 0.8 Hitting force 2.9N Hitting speed 5 time/s	TBD	Touch panel function : No defect Terminal resistance : No defect Linearity : No defect Actuation Force : No defect No appearance defect which affects touch panel function. 2)

- 1) Test in active area.
- 2) Dents, blurs and marks on surface film: neglected.
- 3) 10mm sliding (back and forth) counts as 2 times.
- 4) Each test item uses a test touch panel only once. The tested touch panel is not used in any other tests.
- 5) The touch panel is tested in circumstances in which there is no condensation.
- 6) Temp. cycle test (Heat shock included): the LCD shall be tested after leaving it stabilize at room temperature for 2 hours after the last cycle.
- 7) An operational test was performed after the following conditions. First, the touch panel was left for a certain time under 5V voltages applied (without touch), Then it was left at room temperature (No VDC applied) for 2 hours.
- 8) The reliability test is not an out-going inspection.
- 9) The result of the reliability test is for your reference purpose only. The reliability test is conducted only to examine the touch panel's capability.

No	Description	Drawn	Checked	Checked	Approved

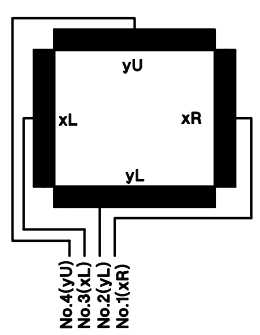

Touch Panel Pin-assign
(Pin-assign from Touch side)
(タッチパネル ピンアサイン、タッチ面側からのピンアサイン)

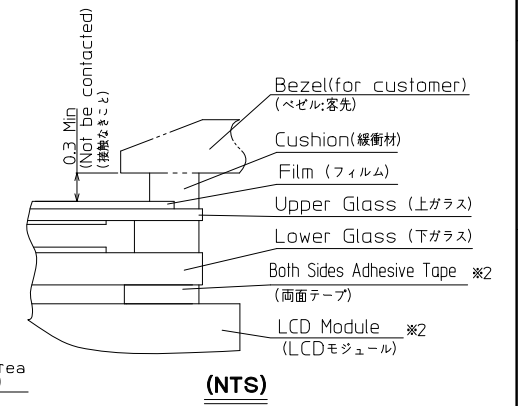
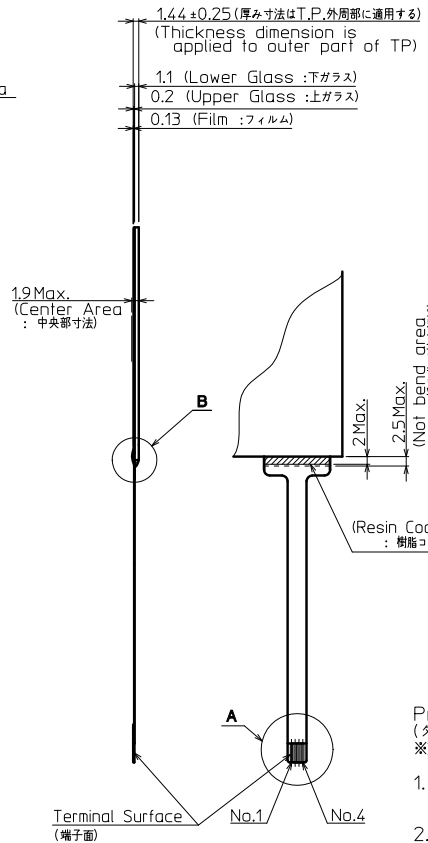
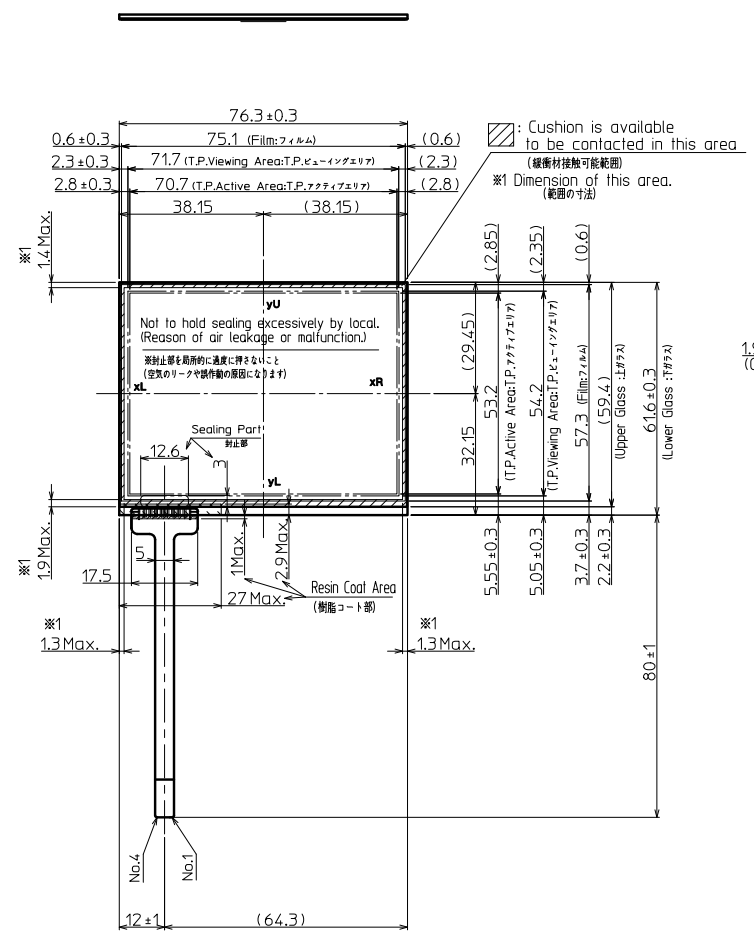

(NTS)

- Precaution in use of touch panel.**
(タッチパネル使用上の注意事項)
※2 In case of assemble to the LCD (LCDに取り付ける場合)
1. Fix touch panel at LCD module and the rear side of touch panel.
(タッチパネルの固定はLCDモジュール側とタッチパネル裏面とで行なうこと)
2. Must maintain a gap between inside of bezel and touch panel to avoid malfunction or electrode damage of touch panel.
(ベゼル内側とタッチパネルの接触厳禁。誤動作や電極破損の原因となります。)
3. Tolerance without indication: ±0.5 (指示無き公差)

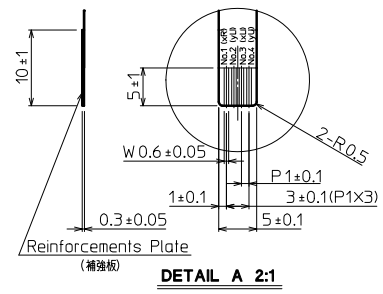
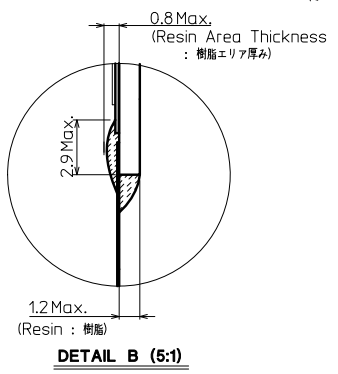

Note. (注記)

Name (名称)	Explanation (説明)
1 T.P. (タッチパネル)	Touch panel
2 T.P. Active Area (T.P. アクティブエリア)	Operating area of touch panel (タッチパネルの動作範囲)
3 T.P. Viewing Area (T.P. ビューイングエリア)	Warranty area of touch panel's appearance (タッチパネルの外観(傷・異物等)保証範囲)

By giving pressure between the active area and the viewing area of the touch panel, there is a possibility that the touch panel will operate.
(タッチパネルアクティブエリアとタッチパネルビューイングエリア間は荷重をかけた場合は、タッチパネルが動作する可能性があります。)

Material 材質	Treatment 処理	Approved 承認	Checked 確認	Checked 確認	Drawn 描	Scale 縮尺	Title 品名	Year-Month-Day 年-月-日	Size 寸数
Quantity 製作数	Description 備考	10.06.08 今村	10.06.08 鶴崎	10.06.08 木口	Scale 1:1(2:1) 5:1(NTS)	KTP035BGAB	10.06.07	2	
T.P. Outline Dimensions							KYOCERA	121A8028100	

Spec No.	TQ3C-8EA00-E2BYE03-00
Date	July 01, 2010

KYOCERA INSPECTION STANDARD

TYPE : KTP035BGAB-C00

KYOCERA CORPORATION
KAGOSHIMA HAYATO PLANT
LCD DIVISION

Original Issue Date	Designed by : Engineering dept.			Confirmed by : QA dept.	
	Prepared	Checked	Approved	Checked	Approved
July 01, 2010	<i>Y. Ikeda</i>	<i>Y. Yamazaki</i>	<i>M. Fujitani</i>	<i>T. Shikama</i>	<i>Ho. Itoh</i>

Spec No. TQ3C-8EA00-E2BYE03-00	Part No. KTP035BGAB-C00	Page -
-----------------------------------	----------------------------	-----------

Revision record



Date		Designed by : Engineering dept.			Confirmed by : QA dept.	
		Prepared	Checked	Approved	Checked	Approved
Rev.No.	Date	Page	Descriptions			

Visuals specification

1) Note

	Note	
General	<ol style="list-style-type: none"> 1. Customer identified anomalies not defined within this inspection standard shall be reviewed by Kyocera, and an additional standard shall be determined by mutual consent. 2. This inspection standard about the image quality shall be applied to any defect within the active area and shall not be applicable to outside of the area. 3. Inspection conditions <ul style="list-style-type: none"> Luminance : 500 Lux min. Inspection distance : 300 mm. Temperature : 25 ± 5°C Direction : Directly above 	
Definition of inspection item	Touch Panel (Scratch , Foreign particle)	Describes scratches on the glass and film and foreign particles between glass/glass or glass/film.

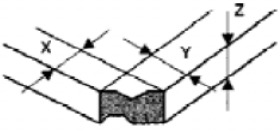
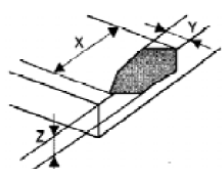
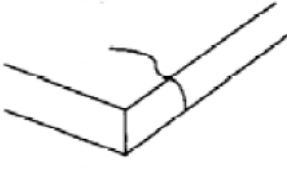
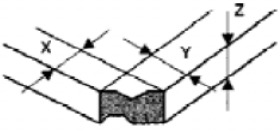
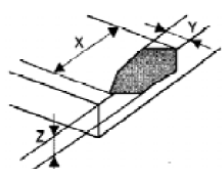
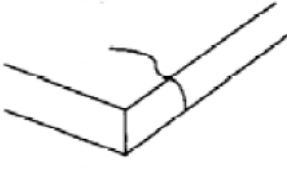
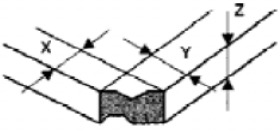
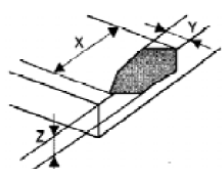
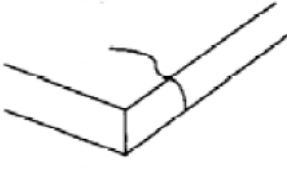
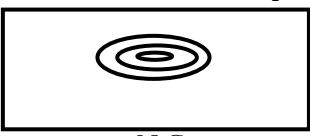
2) Standard

Inspection item	Judgement standard																															
Scratch, Foreign particle (Touch screen portion)	(W = Width, L = Length, D = Diameter = (major axis + minor axis) / 2)																															
	<table border="1"> <thead> <tr> <th>Item</th> <th>Width(mm)</th> <th>Length(mm)</th> <th>Acceptable number</th> </tr> </thead> <tbody> <tr> <td rowspan="4">Scratch</td> <td>$W \leq 0.03$</td> <td>$L \leq 20$</td> <td>Neglected</td> </tr> <tr> <td>$0.03 < W \leq 0.05$</td> <td>$L \leq 10$</td> <td>2pcs within $\phi 20\text{mm}$</td> </tr> <tr> <td>$0.05 < W \leq 0.08$</td> <td>$L \leq 6$</td> <td>2pcs within $\phi 20\text{mm}$</td> </tr> <tr> <td>$0.08 < W \leq 0.1$</td> <td>$L \leq 4$</td> <td>1pcs within $\phi 30\text{mm}$</td> </tr> <tr> <td rowspan="2">Foreign (line like)</td> <td>$W \leq 0.05$</td> <td>Neglected</td> <td>Neglected</td> </tr> <tr> <td>$0.05 < W \leq 0.1$</td> <td>$L \leq 5$</td> <td>2pcs within $\phi 30\text{mm}$</td> </tr> <tr> <td rowspan="2">Foreign (circle like)</td> <td colspan="2">$D \leq 0.2$</td> <td>Neglected</td> </tr> <tr> <td colspan="2">$0.2 < D \leq 0.3$</td> <td>2pcs within $\phi 30\text{mm}$</td> </tr> </tbody> </table>	Item	Width(mm)	Length(mm)	Acceptable number	Scratch	$W \leq 0.03$	$L \leq 20$	Neglected	$0.03 < W \leq 0.05$	$L \leq 10$	2pcs within $\phi 20\text{mm}$	$0.05 < W \leq 0.08$	$L \leq 6$	2pcs within $\phi 20\text{mm}$	$0.08 < W \leq 0.1$	$L \leq 4$	1pcs within $\phi 30\text{mm}$	Foreign (line like)	$W \leq 0.05$	Neglected	Neglected	$0.05 < W \leq 0.1$	$L \leq 5$	2pcs within $\phi 30\text{mm}$	Foreign (circle like)	$D \leq 0.2$		Neglected	$0.2 < D \leq 0.3$		2pcs within $\phi 30\text{mm}$
	Item	Width(mm)	Length(mm)	Acceptable number																												
	Scratch	$W \leq 0.03$	$L \leq 20$	Neglected																												
		$0.03 < W \leq 0.05$	$L \leq 10$	2pcs within $\phi 20\text{mm}$																												
		$0.05 < W \leq 0.08$	$L \leq 6$	2pcs within $\phi 20\text{mm}$																												
		$0.08 < W \leq 0.1$	$L \leq 4$	1pcs within $\phi 30\text{mm}$																												
	Foreign (line like)	$W \leq 0.05$	Neglected	Neglected																												
$0.05 < W \leq 0.1$		$L \leq 5$	2pcs within $\phi 30\text{mm}$																													
Foreign (circle like)	$D \leq 0.2$		Neglected																													
	$0.2 < D \leq 0.3$		2pcs within $\phi 30\text{mm}$																													
Above are applied to the visible area.																																
Unless there are foreign particle and damage affected seriously to the electrical performance out of the active area, we approve of this product.																																
Glass crack (Touch screen portion)	<table border="1"> <thead> <tr> <th>Item</th> <th colspan="2">Size (mm)</th> <th>Acceptable number</th> </tr> </thead> <tbody> <tr> <td rowspan="3">Conner crack </td> <td>X</td> <td>≤ 3</td> <td rowspan="3">2 pcs /panel</td> </tr> <tr> <td>Y</td> <td>≤ 3</td> </tr> <tr> <td>Z</td> <td>$< t$</td> </tr> <tr> <td rowspan="3">Crack in other area than in corner </td> <td>X</td> <td>≤ 5</td> <td rowspan="3">2 pcs /side</td> </tr> <tr> <td>Y</td> <td>≤ 1.5</td> </tr> <tr> <td>Z</td> <td>$< t$</td> </tr> <tr> <td>Progressive crack </td> <td colspan="2"></td> <td>0 pcs (NG even 1pcs)</td> </tr> </tbody> </table>	Item	Size (mm)		Acceptable number	Conner crack 	X	≤ 3	2 pcs /panel	Y	≤ 3	Z	$< t$	Crack in other area than in corner 	X	≤ 5	2 pcs /side	Y	≤ 1.5	Z	$< t$	Progressive crack 			0 pcs (NG even 1pcs)							
	Item	Size (mm)		Acceptable number																												
	Conner crack 	X	≤ 3	2 pcs /panel																												
		Y	≤ 3																													
		Z	$< t$																													
	Crack in other area than in corner 	X	≤ 5	2 pcs /side																												
		Y	≤ 1.5																													
Z		$< t$																														
Progressive crack 			0 pcs (NG even 1pcs)																													
Above are applied to the visible area.																																
Unless there are foreign particle and damage affected seriously to the electrical performance out of the active area, we approve of this product.																																
Newton's ring	<p>All Newton Rings in the center of the screen must be rejected. Border around the screen are permitted.</p> <div style="display: flex; justify-content: space-around; align-items: center;"> <div style="text-align: center;">  <p>NG</p> </div> <div style="text-align: center;">  <p>OK</p> </div> </div>																															