



LCD Module Technical Specification

First Edition
Oct 17, 2001
Final Revision

T-51382D064-FW-P-AB

Checked by (Quality Assurance Div.)

Checked by (Design Engineering Div.)

Prepared by (Production Div.)

Table of Contents

1. Applications	2
2. Features	2
3. Mechanical Specifications	2
4. Mechanical Drawing TFT LCD Module	3
5. Input / Output Terminals	5
6. Absolute Maximum Ratings	6
7. Electrical Characteristics	6
8. Power Sequence	12
9. Optical Characteristics	13
10. Reliability TEST	16
11. Block Diagram	17

Revision History

Rev.	Date	Page	Comment

www.DataSheet4U.com

1. Application

This product applies computer peripheral, industrial meter, image communication, web-pad, e-boobs and multi-media.

2. Features

- . Pixel in stripe configuration
- . Slim and compact
- . Display Colors :262,144 colors
- . Viewing Direction : 6 o'clock
- . Slim module design for mobile electronics device application

3. Mechanical Specifications

Parameter	Specifications	Unit
Screen Size	6.4 (diagonal)	inch
Display Format	640×R, G, B×480	dot
Active Area	129.6(H)×97.44 (V)	mm
Dot Pitch	0.0675 (H)×0.203 (V)	mm
Pixel Pitch	0.203 (H)×0.203 (V)	mm
Pixel Configuration	Stripe	
Outline Dimension	See Mechanical Drawing	mm
Weight	165±10	g

4. Mechanical Drawing of TFT-LCD Module

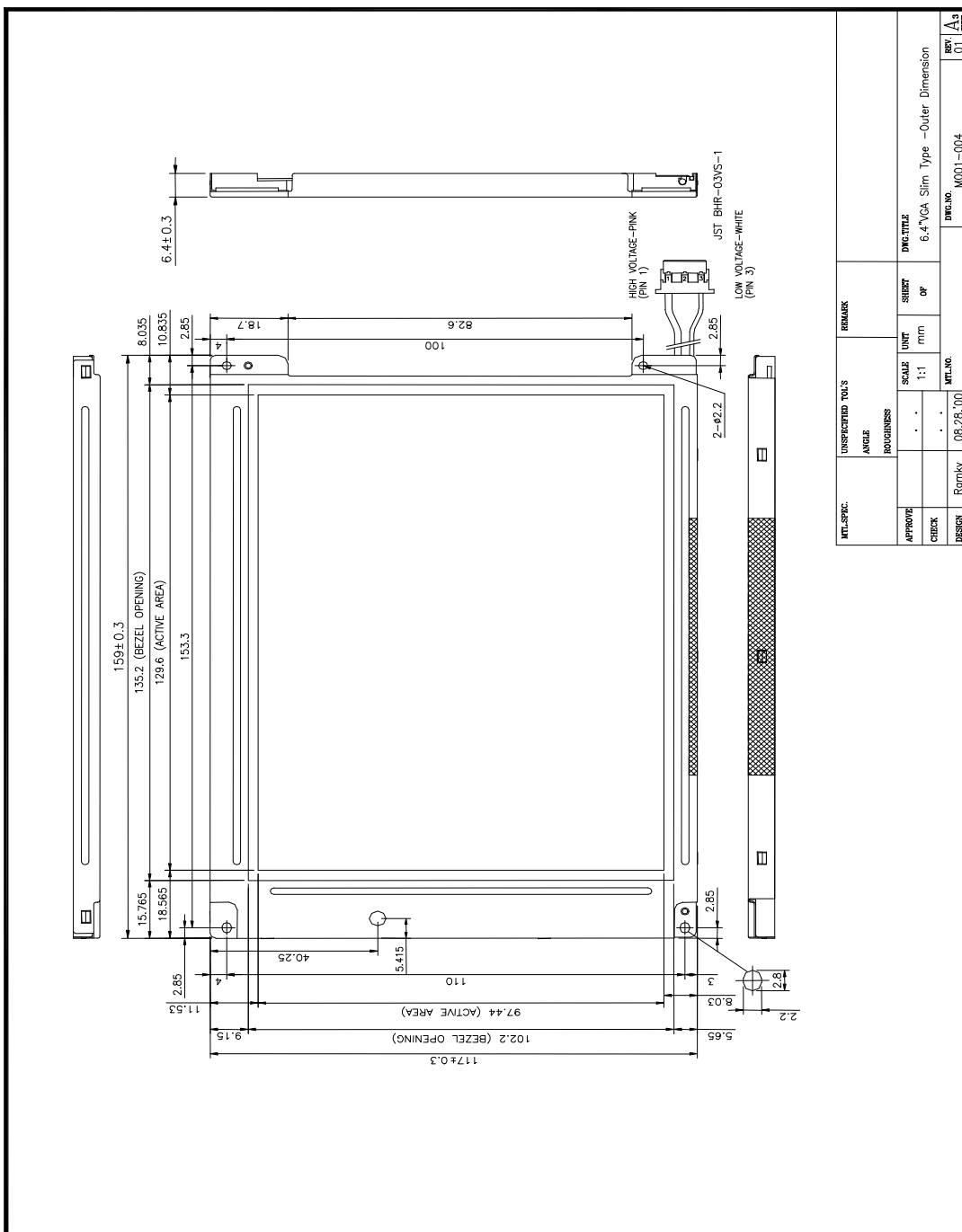

MTL SPEC.	UNSPECIFIED TOL'S	REMARK	SCALE	UNIT	SHEET	DWG TITLE
	ANGLE		1:1	mm	OF	6.4"VGA Slim Type - Outer Dimension
APPROVE	ROUGHNESS					
CHECK						
DESIGN	FORMLY	08,28,100	MTL.No.			DWG.No. M001-004
						REV. A 3
						U 1582

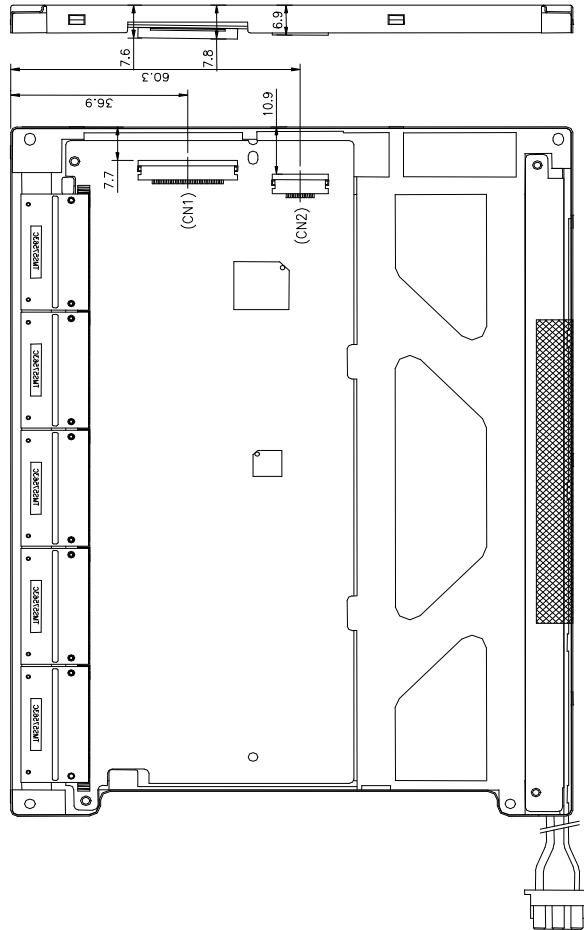

NOTE:

- 1).CN1:ELCO, 6210-30P
- 2).CN2:JST FLH-RSM1-12PIN

MTL SPEC.	UNSPECIFIED TOOLS	REMARK		
ANGLE	ROUGHNESS			
APPROVE	SCALE	UNIT	SHEET	DWG TITLE
CHECK	1:1	mm	OF	6.4"VGA Slim Type -Outer Dimension
DESIGN	08.28.00	MTL NO.	DWG NO.	REV. A
	Romyki		M001-004	01
				SIZE

5. Input / Output Terminals

5-1) TFT-LCD Panel Driving

Connector(1) type : ELCO , 6210-30PIN

Pin No.	Symbol	Function	Remark
1	CLK	Clock Signal for Sampling Image Digital Data	
2	Hsync	Horizontal Synchronous Signal	
3	Vsync	Vertical Synchronous Signal	
4	GND	Ground (0V)	
5	R0	Red Image Data Signal (LSB)	
6	R1	Red Image Data Signal	
7	R2	Red Image Data Signal	
8	R3	Red Image Data Signal	
9	R4	Red Image Data Signal	
10	R5	Red Image Data Signal (MSB)	
11	GND	Ground (0V)	
12	G0	Green Image Data Signal (LSB)	
13	G1	Green Image Data Signal	
14	G2	Green Image Data Signal	
15	G3	Green Image Data Signal	
16	G4	Green Image Data Signal	
17	G5	Green Image Data Signal (MSB)	
18	GND	Ground (0V)	
19	B0	Blue Image Data Signal (LSB)	
20	B1	Blue Image Data Signal	
21	B2	Blue Image Data Signal	
22	B3	Blue Image Data Signal	
23	B4	Blue Image Data Signal	
24	B5	Blue Image Data Signal (MSB)	
25	GND	Ground (0V)	
26	NC	No connection	
27	VCC	DC +3.3V Power Supply	
28	VCC	DC +3.3V Power Supply	
29	NC	No connection	
30	NC	No connection	

5-2) Backlight driving

Pin No	Symbol	Description	Remark
1	VL1	Input terminal (Hi voltage side)	Wire color : Pink
2	NC	No Connection	
3	VL2	Input terminal (Low voltage side)	Wire Color : White Note 5-1

Note 5-1 : Low voltage side of backlight inverter connects with ground of inverter circuits.

5-3) Input / Output Connector

A) LCD module connector
ELCO , 6210-30PIN
Down Connector
Pin No. 30
Pitch 0.5 mm

B) Backlight Connector
JST BHR-03VS-1
Pin No. 3
Pitch 4 mm
Red: High Voltage
White: Low Voltage

6. Absolute Maximum Ratings:

GND=0V, Ta=25C

Parameters	Symbol	MIN.	MAX.	Unit	Remark
+3.3V Supply Voltage	V_{CC}	-0.3	+4.0	V	
Input Signals Voltage	V_{sig}	-0.3	$V_{CC}+0.3$	V	Note 6-1
Storage Temperature	T_{stg}	-20	+70		Note 6-2
Operating Temperature	T_{opa}	-0	+60		

Note 6-1: Input signals include CLK, Hsync, Vsync, R[0:5], G[0:5] and B[0:5].

Note 6-2: Humidity : 95% RH Max. at $T_a \leq 40C$.

Maximum wet-bulb temperature is at 39C or less at $T_a > 40 C$.
No condensation.

7. Electrical Characteristics

7-1) Recommended Operating Conditions:

A) Driving for TFT-LCD panel

GND = 0V, $T_a = 25 C$

Parameters	Symbol	Min.	Typ.	Max.	Unit	Remark
+3.3V Supply Voltage	V_{CC}	+3.15	+3.3	+3.6	V	
Supply Input Ripple Voltage	V_{CCRP}			0.1	Vp-p	$V_{CC}=+3.3V$
Input Signals Voltage (High)	V_{IH}	+3.0	+3.3	+3.6	V	
Input Signals Voltage (Low)	V_{IL}	-	0	+0.3	V	

B) Driving for backlight

$T_a = 25 C$

Item	Symbol	Min.	Typ.	Max.	Unit	Remark
Lamp Current	I_L	3	5	7	mA	
Lamp Voltage	V_L	320	350	380	Vrms	
Oscillation	P_L	45	64	80	KHz	
Lamp Life Time		-	20,000	-	Hr	
Kick-off voltage(25)	V_s	-	845	1,050	Vrms	
Kick-off voltage(0)	V_s	-	1,045	1,250	Vrms	

7-2) Power Consumption

Parameters	Symbol	Typ.	Max.	Unit	Remark
+3.3V Current Dissipation	I_{CC}	290	330	mA	
Input Signals Current (High)	I_{IH}		100	A	$V_{IH} = +3.3V$
Input Signals Current (Low)	I_{IL}		100	A	$V_{IL} = 0V$
LCD Panel Power Consumption		0.96		W	Note 7-1
Backlight Power Consumption		1.75	2.66	W	Note 7-2

Note 7-1 : The power consumption of backlight is not included.

Note 7-2 : Backlight lamp power consumption is calculated by $L \times V_L$.

7-3) Input / Output signal timing chart

	Parameters	Symbol	Min.	Typ.	Max.	Unit	Note
	Frequency	$F_c = 1/T_c$		25.17 5		MHz	Note 7-3
Clock	High Time	T_{ckh}	10			ns	
	Low Time	T_{ckl}	10			ns	
	Periodic = Line	T_{hp}		31.77 8		s	Note 7-3
Hsync				800	1024	clock	Note 7-3
	Pulse Width	T_{hpw}	2	96	200	clock	
	Back Porch	T_{hbp}	2	49	64	clock	
			515	525	1024	line	Note 7-3
Vsync	Pulse Width	T_{vpw}	1	2		line	
	Back Porch	T_{vbp}	1	33	64	line	
Data	Setup Time	T_{ds}	10			ns	
	Hold Time	T_{dh}	10			ns	
	Periodic = Line	T_{ep}		800	1024	clock	
	Pulse Width (H)	T_{epw}	2	640	800	clock	
	Horizontal Display Periodic	T_{hd}	640	640	640	clock	
	Hsync-CLK Phase Difference	T_{hc}	10		$T_c - 10$	ns	
	Vsync-Hsync Phase Difference	T_{vh}	1		$T_{hp} - 1$	clock	

Note 7-3 : T_c is the period of sampling clock. In case of low-frequency, the image-flicker may occur.

7-4) Display Time Range

(1) Vertical Timing :

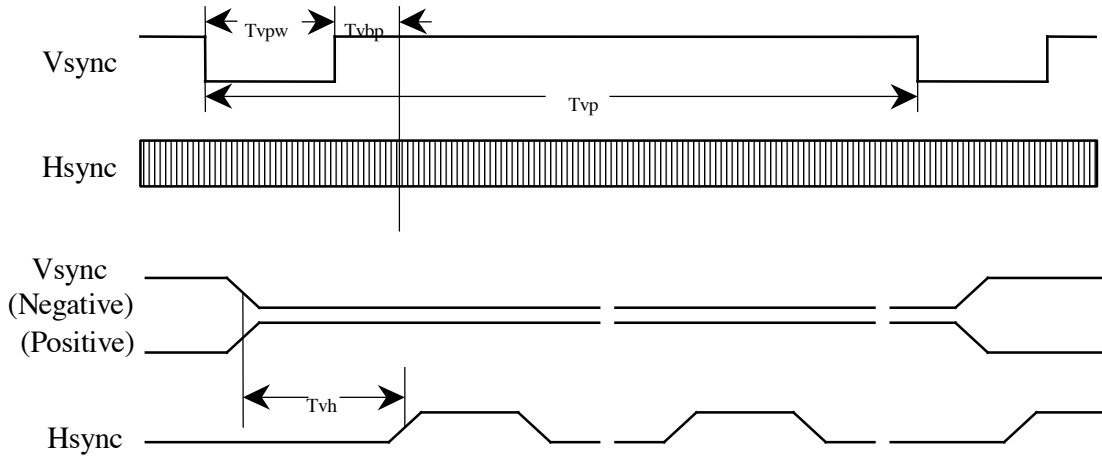

(2) Horizontal Timing :

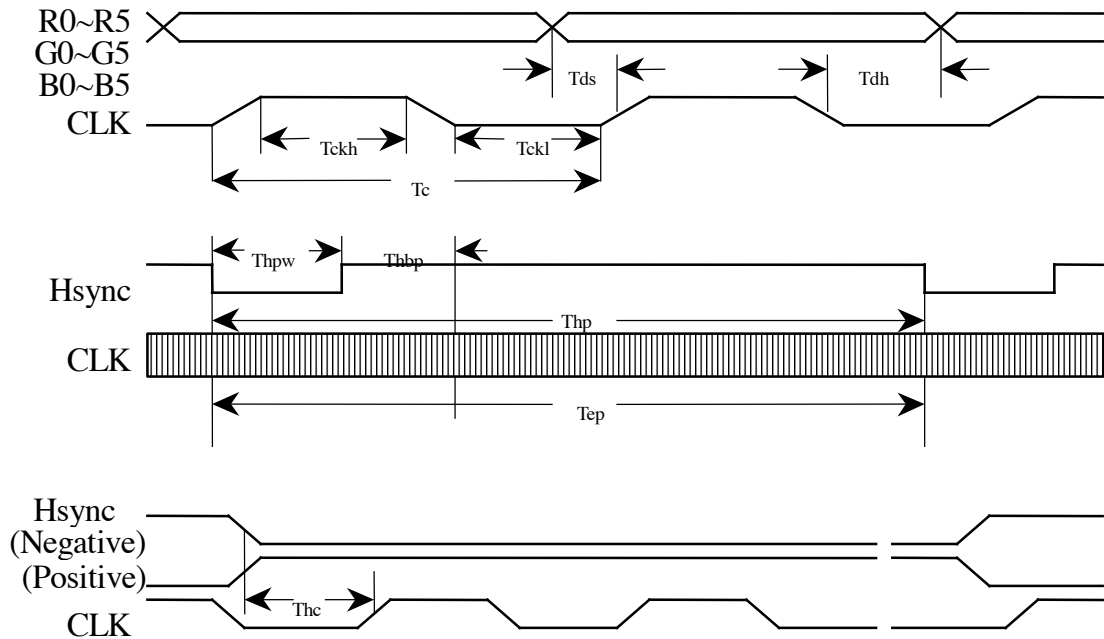

(3). Detail of Horizontal Timing :

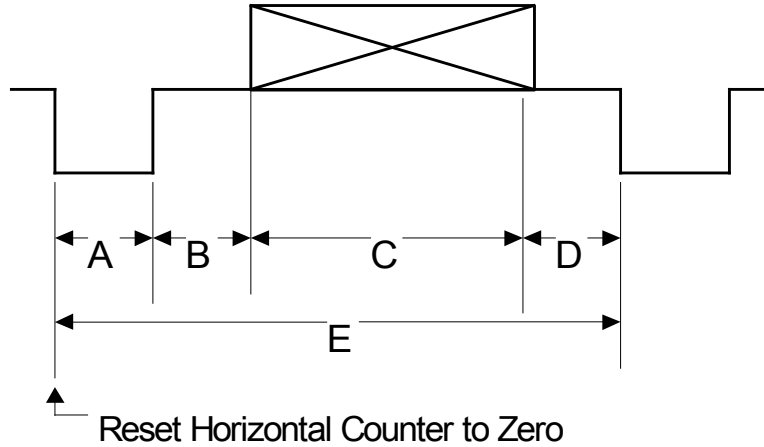

Item	Description	Clock Cycles	Time
A	Horizontal Width	96	3.813 s
B	Horizontal B-Porch	49	1.907 s
C	Horizontal Display	640	25.422 s
D	Horizontal F-Porch	16	0.636 s
E	Horizontal Total	800	31.778 s

(4). Detail of Vertical Timing :

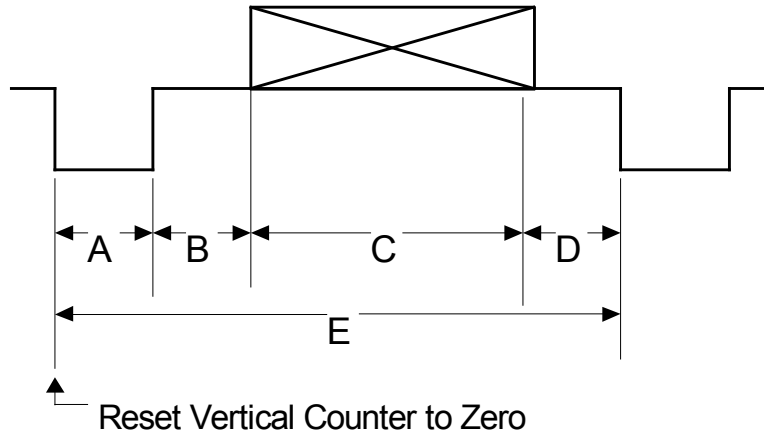

Item	Description	Horizontal Lines	Time
A	Vertical Width	2	63.5 s
B	Vertical B-Porch	33	1.049 ms
C	Vertical Display	480	15.253 ms
D	Vertical F-Porch	10	317.8 s
E	Vertical Total	525	16.683 ms

7-5) Pixel Arrangement

The LCD module pixel arrangement is the stripe.

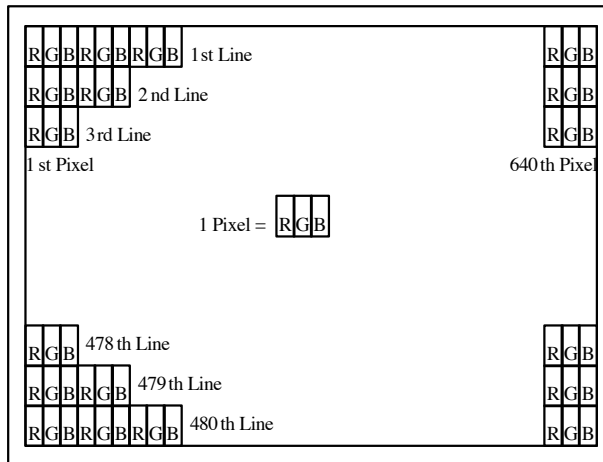

7-6) Display Color and Gray Scale Reference

Color		Input Color Data																	
		Red						Green						Blue					
		R5	R4	R3	R2	R1	R0	G5	G4	G3	G2	G1	G0	B5	B4	B3	B2	B1	B0
Basic Colors	Black	0	0	0	0	0	0	0	0	0	0	0	0	0	0	0	0	0	0
	Red (63)	1	1	1	1	1	1	0	0	0	0	0	0	0	0	0	0	0	0
	Green (63)	0	0	0	0	0	0	1	1	1	1	1	1	0	0	0	0	0	0
	Blue (63)	0	0	0	0	0	0	0	0	0	0	0	0	1	1	1	1	1	1
	Cyan	0	0	0	0	0	0	1	1	1	1	1	1	1	1	1	1	1	1
	Magenta	1	1	1	1	1	1	0	0	0	0	0	0	1	1	1	1	1	1
	Yellow	1	1	1	1	1	1	1	1	1	1	1	1	0	0	0	0	0	0
	White	1	1	1	1	1	1	1	1	1	1	1	1	1	1	1	1	1	1
Red	Red (00)	0	0	0	0	0	0	0	0	0	0	0	0	0	0	0	0	0	0
	Red (01)	0	0	0	0	0	1	0	0	0	0	0	0	0	0	0	0	0	0
	Red (02)	0	0	0	0	1	0	0	0	0	0	0	0	0	0	0	0	0	0
	Darker																		
	↓	↓	↓	↓	↓	↓	↓	↓	↓	↓	↓	↓	↓	↓	↓	↓	↓	↓	↓
	Brighter																		
	Red (61)	1	1	1	1	0	1	0	0	0	0	0	0	0	0	0	0	0	0
	Red (62)	1	1	1	1	1	0	0	0	0	0	0	0	0	0	0	0	0	0
Red (63)	1	1	1	1	1	1	0	0	0	0	0	0	0	0	0	0	0	0	
Green	Green (00)	0	0	0	0	0	0	0	0	0	0	0	0	0	0	0	0	0	0
	Green (01)	0	0	0	0	0	0	0	0	0	0	0	1	0	0	0	0	0	0
	Green (02)	0	0	0	0	0	0	0	0	0	0	1	0	0	0	0	0	0	0
	Darker																		
	↓	↓	↓	↓	↓	↓	↓	↓	↓	↓	↓	↓	↓	↓	↓	↓	↓	↓	↓
	Brighter																		
	Green (61)	0	0	0	0	0	0	1	1	1	1	0	1	0	0	0	0	0	0
	Green (62)	0	0	0	0	0	0	1	1	1	1	1	0	0	0	0	0	0	0
Green (63)	0	0	0	0	0	0	1	1	1	1	1	1	0	0	0	0	0	0	
Blue	Blue (00)	0	0	0	0	0	0	0	0	0	0	0	0	0	0	0	0	0	0
	Blue (01)	0	0	0	0	0	0	0	0	0	0	0	0	0	0	0	0	0	1
	Blue (02)	0	0	0	0	0	0	0	0	0	0	0	0	0	0	0	0	1	0
	Darker																		
	↓	↓	↓	↓	↓	↓	↓	↓	↓	↓	↓	↓	↓	↓	↓	↓	↓	↓	↓
	Brighter																		
	Blue (61)	0	0	0	0	0	0	0	0	0	0	0	0	1	1	1	1	0	1
	Blue (62)	0	0	0	0	0	0	0	0	0	0	0	0	1	1	1	1	1	0
Blue (63)	0	0	0	0	0	0	0	0	0	0	0	0	1	1	1	1	1	1	

8. Power On Sequence

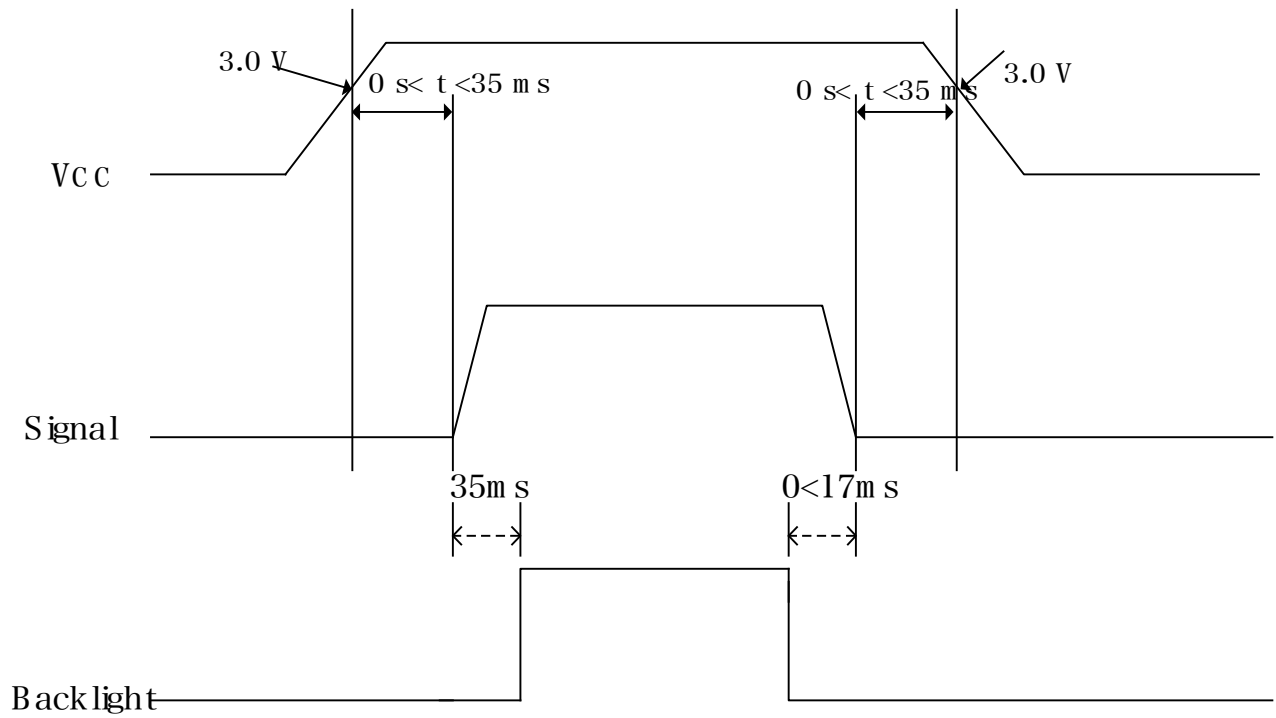

1. The supply voltage for input signals should be same as V_{CC} .
2. When the power is off , please keep whole signals (Hsync, Vsync, CLK, Data) low level or high impedance

9. Optical Characteristics

9-1) Specification:

Ta=25C

Parameter	Symbol	Condition	MIN.	TYP.	MAX.	Unit	Remarks
Viewing Angle	Horizontal	θ	± 35	± 45		deg	Note 9-3
	Vertical	θ (to 12 o'clock)	10	15	-	deg	
		θ (to 6 o'clock)	30	35	-	deg	
Contrast Ratio	CR		150	180	-	-	Note 9-1
Response time	Rise	Tr	-	15	30	ms	Note 9-4
	Fall	Tf	-	25	50	ms	
Brightness		$\theta = 0^\circ / \phi = 0$	80	120		cd/m ²	Note 9-2
Luminance Uniformity	U		55	80	-	%	Note 9-6
Lamp Life Time			-	20,000	-	hr	
White Chromaticity	x		0.230	0.280	0.330	-	
	y		0.270	0.320	0.370	-	
Cross Talk		$\theta = 0^\circ$	-	-	3	%	Note 9-5

All the optical measurement shall be executed 30 minutes after backlight being turn-on. The optical characteristics shall be measured in dark room (ambient illumination on panel surface less than 1 Lux). The measuring configuration shows as following figure.

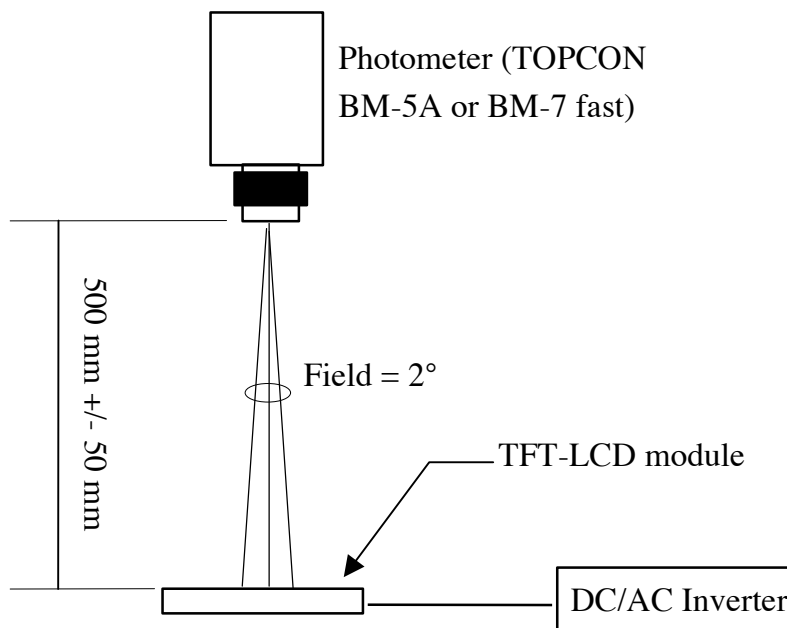

Optical characteristics measuring configuration

Note 9-1 : $CR = \frac{\text{Luminance when LCD is White}}{\text{Luminance when LCD is Black}}$

Contrast Ratio is measured in optimum common electrode voltage.

Note 9-2 : Topcon BM-7(fast) luminance meter 2° field of view is used in the testing (after 20~30 minutes' operation).

Note 9-3 : The definitions of viewing angle diagrams:

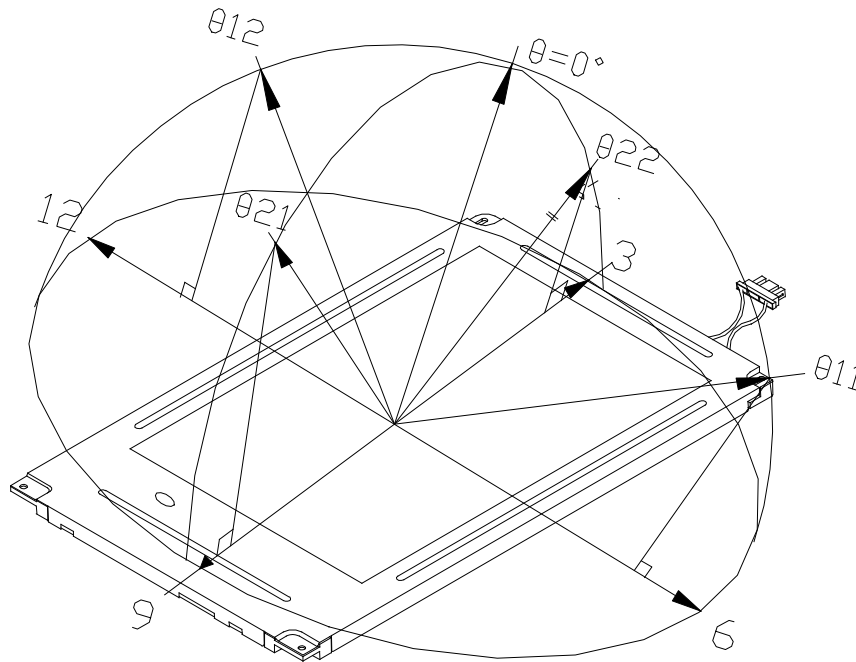

Note 9-4: Definition of Response Time T_r and T_f :

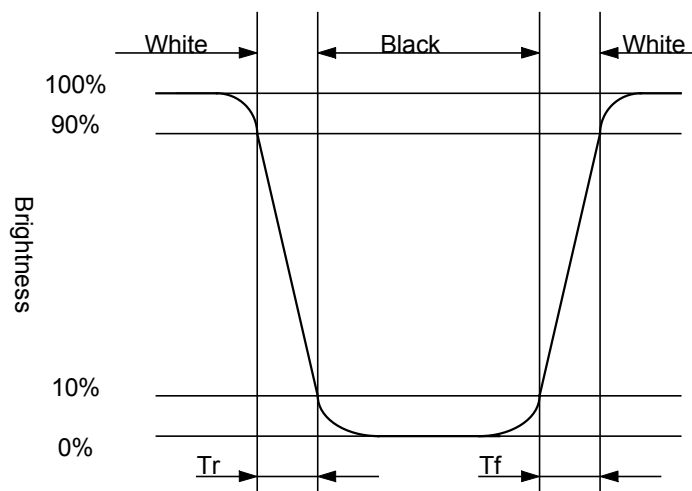

Note 9-5: Cross Talk (CTK) = $\frac{YA-YB}{YA} \times 100\%$

YA: Brightness of Pattern A

YB: Brightness of Pattern B
Pattern A

(Gray Level 31)

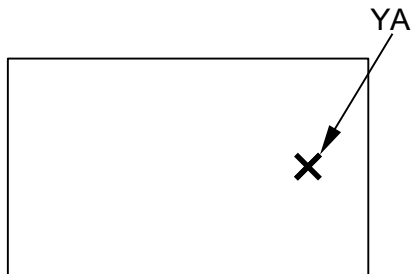

Pattern B
(Gray Level 31, central
black box exclusive)

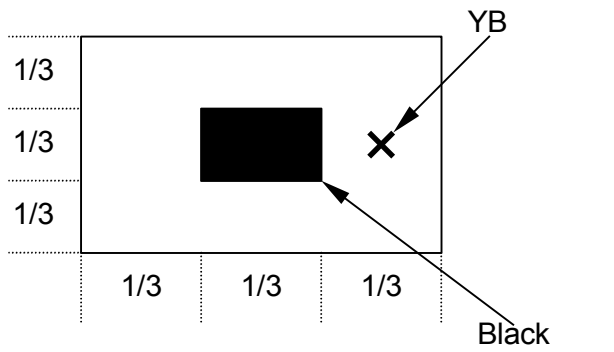

✕: Testing Point (A and B are at the same point.)

(Gray Level 0)

Note 9-6: The uniformity of LCD is defined as

$$U = \frac{\text{The Minimum Brightness of the 9 testing Points}}{\text{The Maximum Brightness of the 9 testing Points}}$$

Luminance meter : BM-5A or BM-7 fast(TOPCON)

Measurement distance : 500 mm +/- 50 mm

Ambient illumination : < 1 Lux

Measuring direction : Perpendicular to the surface of module

The test pattern is white (Gray Level 63).

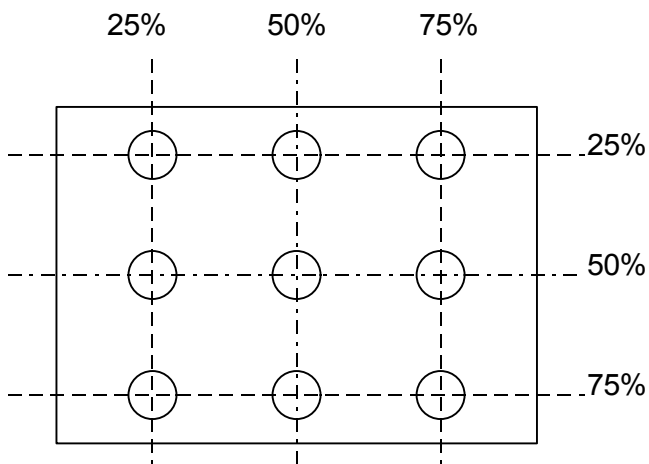

10. Reliability Test

No	Test Item	Test Condition
1	High Temperature Storage Test	Ta = +70 C, 240 hrs
2	Low Temperature Storage Test	Ta = -20 C, 240 hrs
3	High Temperature Operation Test	Ta = +60 C, 240 hrs
4	Low Temperature Operation Test	Ta = 0 C, 240 hrs
5	High Temperature & High Humidity Operation Test	Ta = +40 C, 95%RH, 240 hrs
6	Thermal Cycling Test (non-operating))	-25C →+25C →+70C, 200 Cycles 30 min 5min 30min
7	Vibration Test (non-operating)	Frequency : 10 ~ 57 Hz/Vibration Width :0.075mm 58-500 Hz/ Gravity :9.8m/s ² Sweep time: 11 minutes Test period: 3 hrs for each direction of X, Y, Z
8	Shock Test (non-operating)	Gravity :490m/s ² Direction: ±X, ±Y, ±Z Pulse Width :11ms, half sine wave
9	Electrostatic Discharge Test (non-operating)	150pF, 330Ω Air : ±15KV ; Contact : ±8KV 10 times/point, 9 point/panel face

Ta: ambient temperature

[Judgement Criteria]

Under the display quality test conditions with normal operation state , there should be no change which may affect practical display function.

11. Block Diagram

