

LCD Module Technical Specification

Type No. **T-51440GL070H-FW-AF**

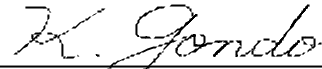

Approved by (Quality Assurance Division)



Checked by (ACI Engineering Division)

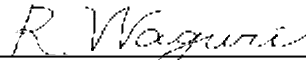

Prepared by (Module Coordination Group)

Table of Contents

1. Application	2
2. General Specifications	2
3. Operating Conditions	3
4. Electrical Specifications	4
5. Optical Specifications	11
6. I/O Terminal	16
7. Test	21
8. Appearance Standards	23
9. Code System of Production Lot	26
10. Type Number	26
11. Applying Precautions	26
12. Precautions Relating Product Handling	27
13. Warranty	28

Revision History

Rev.	Date	Page	Comment

1. Application

This specification applies to 7.0"color TFT-LCD module(T-51440GL070H-FW-AF).
The applications of the panel are for automotive entertainment and car navigation.

2. General Specifications

Screen Size	: 7 inches (18cm) diagonal
Display Mode	: Normally White
Driving Method	: a-Si TFT active matrix format Line Scan/non-interlace Reverse Horizontal Line
Composition	: TFT Cell, Driver IC, Timing controller IC, Backlight unit, Inverter DC/DC Converter, and Video circuit
Input Power Supply	: +8V-16V(DC)
Input Signal	: Composite Video Signal (NTSC/PAL) or Specific Analog RGB signal (NTSC/PAL) + Composite or Separate Synchronized signal
Output Signal	: Horizontal/Vertical Synchronized signal (negative)
Resolution	: 480(W) x 234(H)
Dot Resolution	: 1440(W) x 234(H)
Dot Pitch	: 0.3210(W) x 0.3720(H) mm
Pixel Configuration	: RGB Stripe
Active Area	: 154.08(W) x 87.048(H) mm
Backlight	: Triple wavelength L-shaped Cold Cathode Fluorescent Lamp, Dimming Ratio 1-100%
Viewing Direction	: 6 O'clock (Maximum Contrast)
Surface Treatment	: AGLR Coating (Low Reflectance)
Outer Dimension	: 164.9(W) x 101.9(H) x 23.1(D) mm
Weight	: 300g max.
Attached Drawing	: Dimensional Outline UE-210777

3. Operating Conditions

Item		Conditions	Temperature Range	Remark
Operating Temperature Range	LCD Module w/Backlight	Ambient Temperature (Panel Surface)	-30~75°C (-30~85°C)	Note3-1,3-2
	LCD Panel	Surface Temperature	-30~85°C	
Storage Temperature Range	LCD Module w/Backlight	Surface Temperature	-40~85°C	Note3-3
	LCD Panel	Surface Temperature	-40~85°C	

Note2-1: Operating temperature range defines the operation only and the contrast, response time and other display optical characteristics are set at Ta=+25°C.

Note2-2: Panel surface temperature indicates the temperature of the backlight panel surface on the five points from the four corners and the center. Also note that the panel temperature of backlight side is 10°C (reference value) higher than the other side.

Note2-3: Backlight is not activated.

4. Electrical Specifications

4.1. Absolute Maximum Ratings

Item		Symbol	Conditions	Min.	Max.	Unit
Power Supply	Video Circuit	V_{PW}	$T_a=25\pm 5^\circ\text{C}$ $V_{SS}=0\text{V}$	$V_{SS}-0.2$	16.0	V
	Backlight	V_{BL}		$V_{SS}-0.2$	16.0	V
Input Signal	Composite Video	VIDEO	$T_a=25\pm 5^\circ\text{C}$ 75Ω $V_{PW}=V_{BL}=+12.0\text{V}$	-	1.5	V_{P-P}
	Analog RGB	R,G,B		-	1.5	V_{P-P}
	Chroma Signal	CYSYNC		-	1.5	V_{P-P}
	Synchronous Signals	VS,Y,HSY	$T_a=25\pm 5^\circ\text{C}$ $V_{SS}=0\text{V}$ $V_{PW}=V_{BL}=+12.0\text{V}$	-	3.6	V_{P-P}
	Adjustment Signals	COLOR, BRT,CONT, TINT,DIM		$V_{SS}-0.3$	$V_{DD}+0.3$	V
	Switching Signals	U/D,R/L, MOD1~3, N/P,R/CMP, Y/CMP		$V_{SS}-0.3$	-	V

Note: Absolute maximum ratings should not exceed the limit anytime. If the product exceeds the limit, it may cause damage. Please be cautious to the changes in supply voltage, connection parts, surge of signals and ambient temperature.

4.2. Recommended Operating Conditions

($T_a=25\pm 5^\circ\text{C}$, $V_{SS}=0\text{V}$)

Item		Symbol	Condition	Min.	Typ.	Max.	Unit
Power Supply	System	V_{PW}		8.0	12.0	16.0	V
	Backlight	V_{BL}		8.0	12.0	16.0	V
Input Signals	Composite Video	VIDEO	75Ω		1.0		Vp-p
	Analog RGB	R,G,B			0.7		Vp-p
	Chroma Signal	YCSYNC			1.0		Vp-p
	Synchronous Signals	HSY,VS,Y			0.7	3.3	Vp-p
	Brightness	BRT			2.4		V
	Tint	TINT		1.0	2.7		V
	Color	COLOR			2.0		V
	Contrast	CONT			2.2		V
	Backlight Dimmer	DIM		1		100	%
	Select Signals	MOD1~3,N/P U/D,R/CMP R/L,Y/CMP	H level		OPEN		V
		L level	0		0.7		

Synchronous Frequency	f_{VDN}	NTSC	57.14	59.939	62.86	Hz
	f_{HDN}		15.00	15.734	16.50	KHz
	f_{VDP}	PAL	48.64	50.00	51.20	Hz
	f_{HDP}		15.20	15.625	16.00	KHz
Power Consumption	P_{PW}	$V_{PW}=V_{BL}=12V$ $DIM=3.3V_{DC}$		2400		mW
	P_{BL}			4200		

Note: Recommended Operating Conditions defines the guaranteed range of operation and it is out of guarantee if the product exceeds the range even if within the range of Item3.Absolute Maximum Ratings.

Please use within the range of Recommended Operating Conditions.

4.3.Pixel Alignment

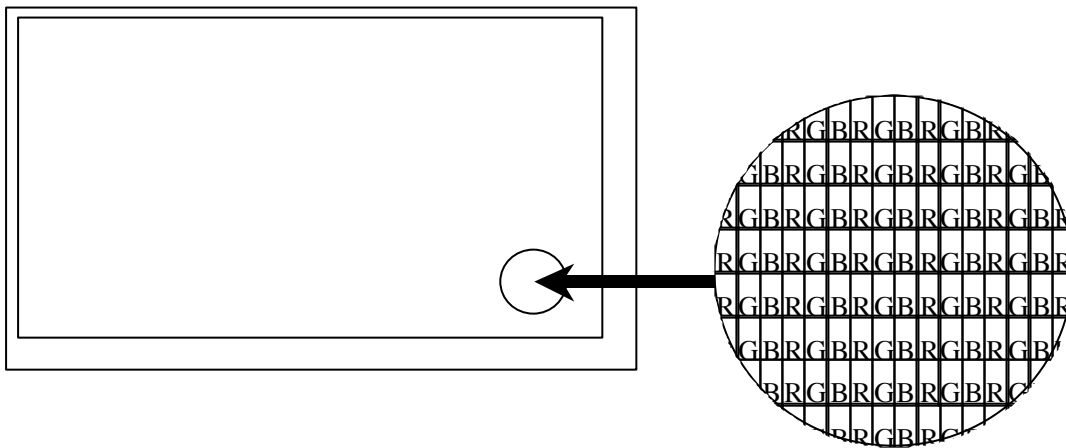

4.4. Timing specification (Analog RGB)

Fig.4-1 Full/Wide/Zoom1,2 mode

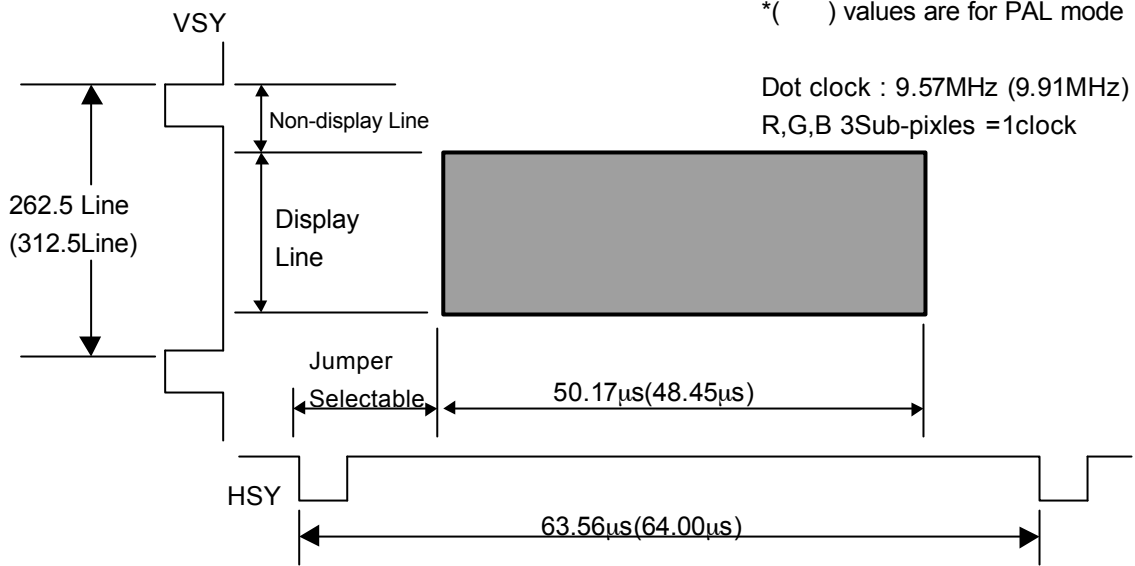

Note: Display mode and Jumper setting can change non-display lines and display lines.

Fig4-2 4:3 mode (Center/Right/Left)

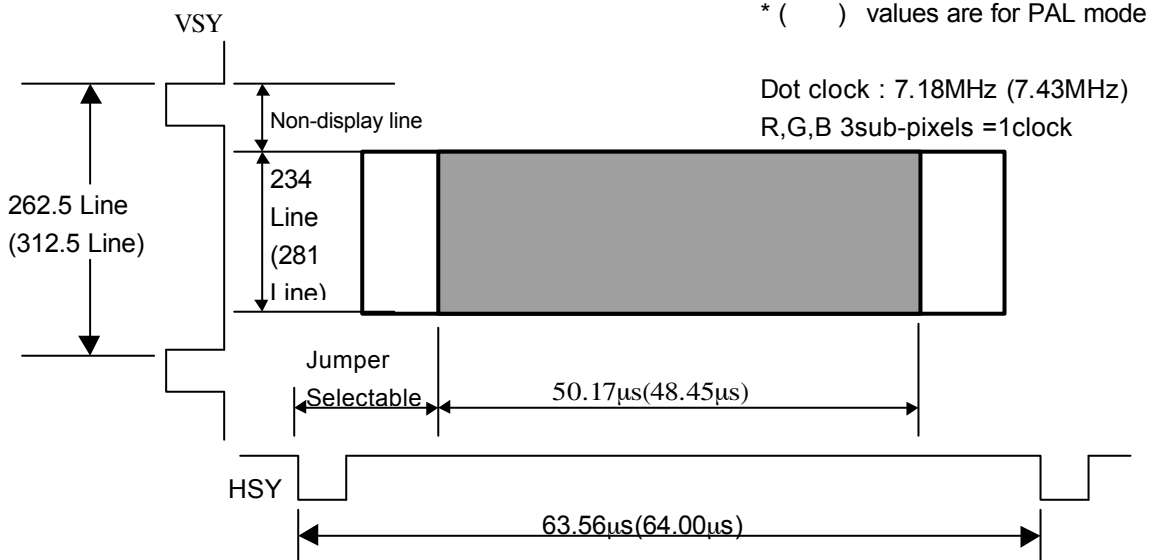

Note: Normal left/right has same value as Normal center values as above.

Fig. 4-3 Horizontal Timing (NTSC/PAL)

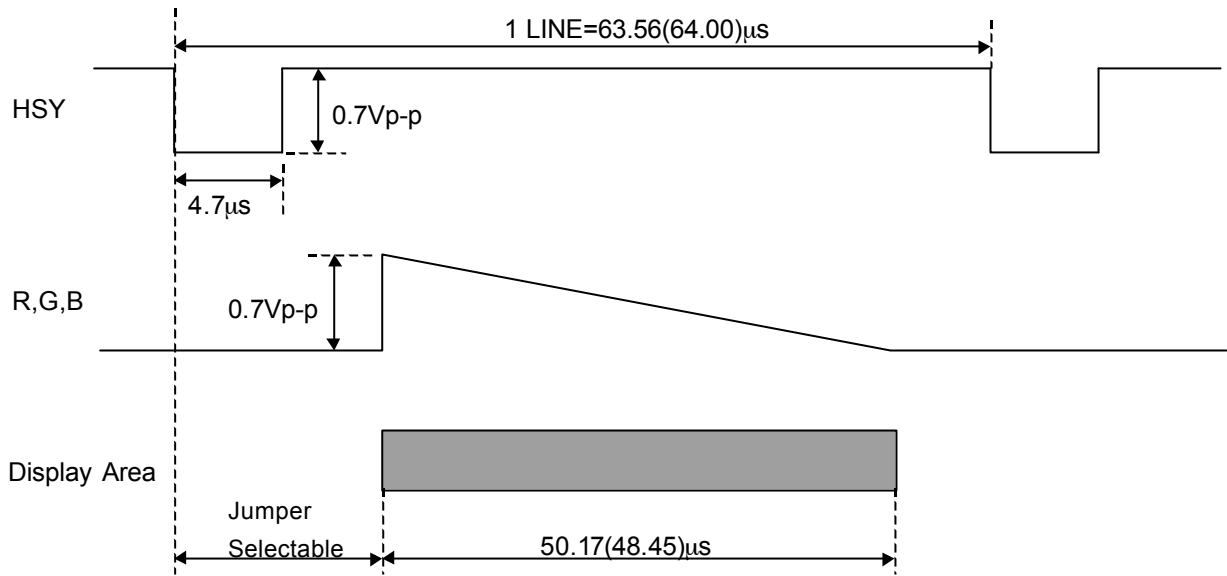

Note : All values are set at typical.

Values within () are values for PAL mode.

$f_H = 15.734(15.625)$ kHz

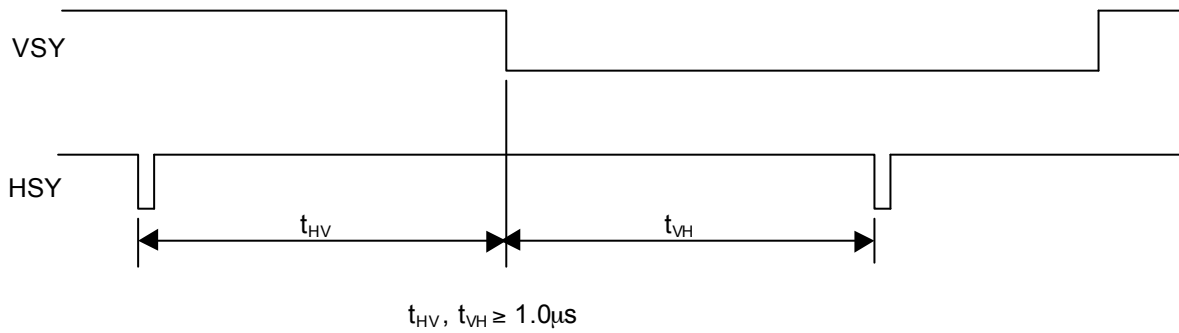
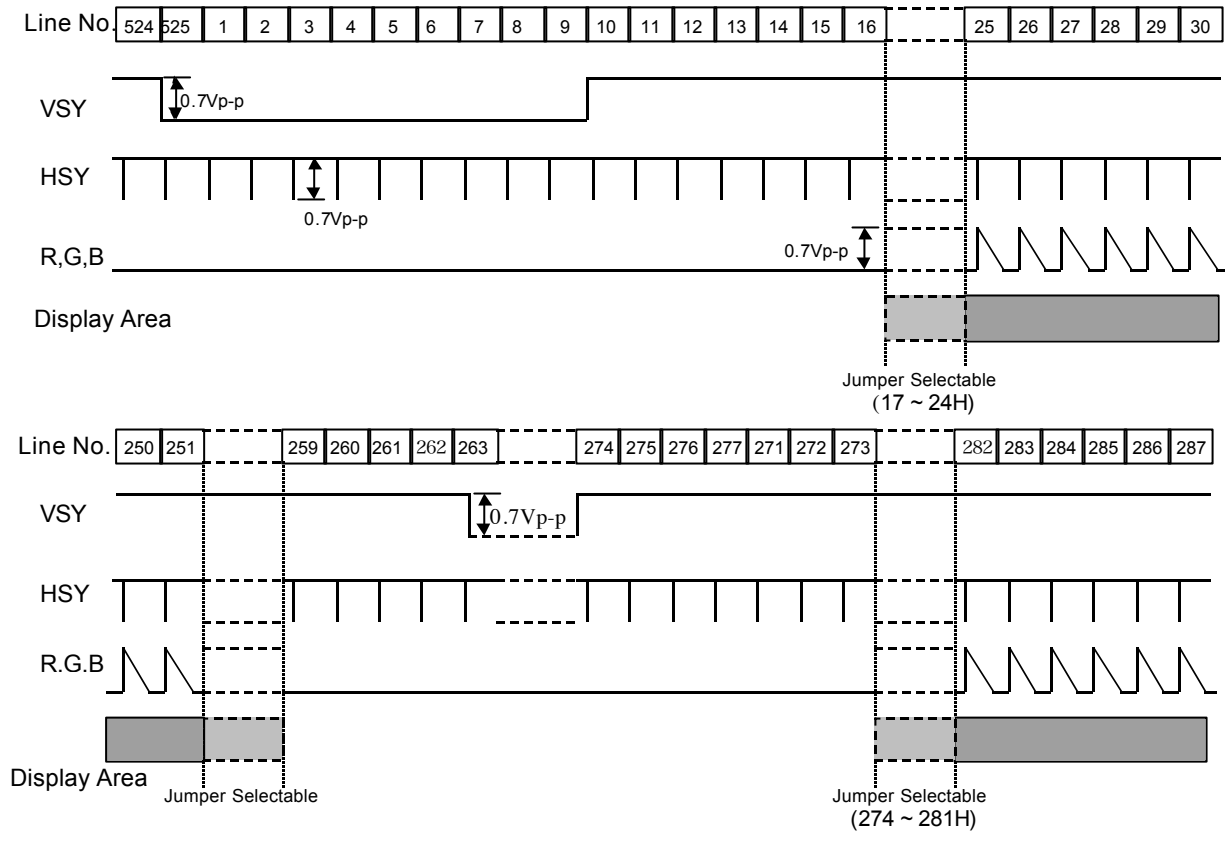

Fig.4-4 Vertical Timing (NTSC: Full/4:3mode)



Note: Wide/Zoom mode has different starting location

4.5.Video Board Adjustment

4.5.1. Jumper Switch (J1,2)

Jumper Switch Number	Contents	Remark																																																																																
J1	Horizontal Display Starting Position Adjust(From HSY) J1 4 3 2 1 <u>Wait Time</u> <table border="1"> <tr><td>OFF</td><td>OFF</td><td>OFF</td><td>OFF</td><td>11.9875uS(13.1875uS</td></tr> <tr><td>OFF</td><td>OFF</td><td>OFF</td><td>ON</td><td>11.6750uS(12.8750uS</td></tr> <tr><td>OFF</td><td>OFF</td><td>ON</td><td>OFF</td><td>11.3625uS(12.5625uS</td></tr> <tr><td>OFF</td><td>OFF</td><td>ON</td><td>ON</td><td>11.0500uS(12.2500uS</td></tr> <tr><td>OFF</td><td>ON</td><td>OFF</td><td>OFF</td><td>10.7375uS(11.9375uS</td></tr> <tr><td>OFF</td><td>ON</td><td>OFF</td><td>ON</td><td>10.4250uS(11.6250uS</td></tr> <tr><td>OFF</td><td>ON</td><td>ON</td><td>OFF</td><td>10.1125uS(11.3125uS</td></tr> <tr><td>OFF</td><td>ON</td><td>ON</td><td>ON</td><td>9.8000uS(11.0000uS</td></tr> <tr><td>ON</td><td>OFF</td><td>OFF</td><td>OFF</td><td>9.4875uS(10.6875uS</td></tr> <tr><td>ON</td><td>OFF</td><td>OFF</td><td>ON</td><td>9.1750uS(10.3750uS</td></tr> <tr><td>ON</td><td>OFF</td><td>ON</td><td>OFF</td><td>8.8625uS(10.0625uS</td></tr> <tr><td>ON</td><td>OFF</td><td>ON</td><td>ON</td><td>8.5500uS(9.7500uS</td></tr> <tr><td>ON</td><td>ON</td><td>OFF</td><td>OFF</td><td>8.2375uS(9.4375uS</td></tr> <tr><td>ON</td><td>ON</td><td>OFF</td><td>ON</td><td>7.9250uS(9.1250uS</td></tr> <tr><td>ON</td><td>ON</td><td>ON</td><td>OFF</td><td>7.6125uS(8.8125uS</td></tr> <tr><td>ON</td><td>ON</td><td>ON</td><td>ON</td><td>7.3000uS(8.5000uS</td></tr> </table> () values are for PAL mode, other values at side black	OFF	OFF	OFF	OFF	11.9875uS(13.1875uS	OFF	OFF	OFF	ON	11.6750uS(12.8750uS	OFF	OFF	ON	OFF	11.3625uS(12.5625uS	OFF	OFF	ON	ON	11.0500uS(12.2500uS	OFF	ON	OFF	OFF	10.7375uS(11.9375uS	OFF	ON	OFF	ON	10.4250uS(11.6250uS	OFF	ON	ON	OFF	10.1125uS(11.3125uS	OFF	ON	ON	ON	9.8000uS(11.0000uS	ON	OFF	OFF	OFF	9.4875uS(10.6875uS	ON	OFF	OFF	ON	9.1750uS(10.3750uS	ON	OFF	ON	OFF	8.8625uS(10.0625uS	ON	OFF	ON	ON	8.5500uS(9.7500uS	ON	ON	OFF	OFF	8.2375uS(9.4375uS	ON	ON	OFF	ON	7.9250uS(9.1250uS	ON	ON	ON	OFF	7.6125uS(8.8125uS	ON	ON	ON	ON	7.3000uS(8.5000uS	Default Set J1-1 : OFF J1-2 : ON J1-3 : OFF J1-4 : OFF J1-5 : ON J1-6 : OFF J1-7 : ON J1-8 : ON
	OFF	OFF	OFF	OFF	11.9875uS(13.1875uS																																																																													
	OFF	OFF	OFF	ON	11.6750uS(12.8750uS																																																																													
OFF	OFF	ON	OFF	11.3625uS(12.5625uS																																																																														
OFF	OFF	ON	ON	11.0500uS(12.2500uS																																																																														
OFF	ON	OFF	OFF	10.7375uS(11.9375uS																																																																														
OFF	ON	OFF	ON	10.4250uS(11.6250uS																																																																														
OFF	ON	ON	OFF	10.1125uS(11.3125uS																																																																														
OFF	ON	ON	ON	9.8000uS(11.0000uS																																																																														
ON	OFF	OFF	OFF	9.4875uS(10.6875uS																																																																														
ON	OFF	OFF	ON	9.1750uS(10.3750uS																																																																														
ON	OFF	ON	OFF	8.8625uS(10.0625uS																																																																														
ON	OFF	ON	ON	8.5500uS(9.7500uS																																																																														
ON	ON	OFF	OFF	8.2375uS(9.4375uS																																																																														
ON	ON	OFF	ON	7.9250uS(9.1250uS																																																																														
ON	ON	ON	OFF	7.6125uS(8.8125uS																																																																														
ON	ON	ON	ON	7.3000uS(8.5000uS																																																																														
	Vertical Display Starting Position Adjust(From VSY) J1 7 6 5 <u>Start Line</u> <table border="1"> <tr><td>OFF</td><td>OFF</td><td>OFF</td><td>24H(36H)</td></tr> <tr><td>OFF</td><td>OFF</td><td>ON</td><td>23H(35H)</td></tr> <tr><td>OFF</td><td>ON</td><td>OFF</td><td>22H(34H)</td></tr> <tr><td>OFF</td><td>ON</td><td>ON</td><td>21H(33H)</td></tr> <tr><td>ON</td><td>OFF</td><td>OFF</td><td>20H(32H)</td></tr> <tr><td>ON</td><td>OFF</td><td>ON</td><td>19H(31H)</td></tr> <tr><td>ON</td><td>ON</td><td>OFF</td><td>18H(30H)</td></tr> <tr><td>ON</td><td>ON</td><td>ON</td><td>17H(29H)</td></tr> </table> () values are for PAL mode, at zoom add 31H(35H)	OFF	OFF	OFF	24H(36H)	OFF	OFF	ON	23H(35H)	OFF	ON	OFF	22H(34H)	OFF	ON	ON	21H(33H)	ON	OFF	OFF	20H(32H)	ON	OFF	ON	19H(31H)	ON	ON	OFF	18H(30H)	ON	ON	ON	17H(29H)																																																	
OFF	OFF	OFF	24H(36H)																																																																															
OFF	OFF	ON	23H(35H)																																																																															
OFF	ON	OFF	22H(34H)																																																																															
OFF	ON	ON	21H(33H)																																																																															
ON	OFF	OFF	20H(32H)																																																																															
ON	OFF	ON	19H(31H)																																																																															
ON	ON	OFF	18H(30H)																																																																															
ON	ON	ON	17H(29H)																																																																															
	J1-8 : Display Image Adjustment Select ON : Internal by Pots. OFF : External by level																																																																																	
J2	J2-1 : ON(Default) J2-2 : ON(Default) J2-3 : UOS(Under On Screen) Display Select ON : Active OFF : Non Active	Default Set J2-1 : ON J2-2 : ON J2-3 : OFF																																																																																

4.5.2. Potentiometers for Display Image Adjustment

Symbol	Contents	Remark
VR301	TINT : Tint Adjustment	For PAL mode, tint tied to 0V
VR302	COLOR : Color Adjustment	
VR305	CONT : Contrast Adjustment	
VR312	BRT : Brightness Adjustment	

4.6.Backlight

Parameter	Symbol	Min.	Typ.	Max.	Units	Remark
Life Time	-	20000	-	-	hours	Note 1,2

Note 1: Reference derived from the use of lamp.

Note 2: When the luminance of lamp is 50% of initial luminance (Under setting of $T_a=25^{\circ}\text{C}$) and continuous standard lighting.

5. Optical Specifications

Item	Symbol	Conditions			Standard Value			Unit	Method of Measure	Remark
		θ	ϕ	C	Min.	Typ.	Max.			
(1)Brightness	B	0°	0°	/	-	(400)	-	Cd/m ²	(Fig.5-1)	Note5-1
(2)Contrast	CR	Optimum Viewing			60	150	-	-		
(3)White Chromaticity	X	0°	0°	/	0.310	0.350	0.390	-		
	Y	0°	0°	/	0.325	0.365	0.405	-		
(4)Brightness Uniformity	-	0°	0°	/	0.7	-	-	-	(Fig.5-2)	
(5)Vertical Viewing Angle	Up	θ_U	-	0°	≥ 10	-	(30)	-	Degree	(Fig.5-3)
	Down	θ_D	-	0°	≥ 10	-	(60)	-	Degree	
(6)Horizontal Viewing Angle	Left	ϕ_L	0°	-	≥ 10	-	(60)	-	Degree	
	Right	ϕ_R	0°	-	≥ 10	-	(60)	-	Degree	
(7)Response Time	Rise	τ_r	0°	0°	/	-	10	20	ms	(Fig.5-4)
	Decay	τ_d	0°	0°	/	-	20	40	ms	

Note5-1: Under the condition of tube current 6.0mA

◆ Conditions for Measuring

- ◇ Environment: Dark room with no light or close to no light.
- ◇ Temperature: 25±5°C
- ◇ Humidity: 40~70%RH
- ◇ After backlight has been lit more than 30 minutes, driving voltage is set for optimal contrast to measure center of display.
- ◇ Measure by the specified inverter or similar product.

◆ Optimal viewing angle (The angle with best contrast)

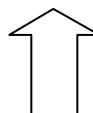
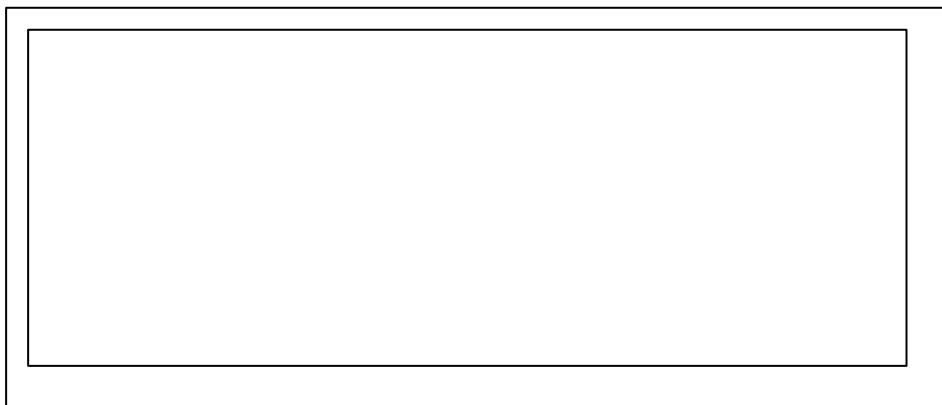

6 O'clock

(Fig.5-1)

◆Method of Brightness Measurement

(1) Measuring Device
TOPCON BM-7, Measuring Field : 1°

(2) Measuring Point
Center of Display $\theta=0^\circ$, $\phi=0^\circ$
On condition θ : A vertical angle from measuring direction to perpendicular.
 ϕ : A horizontal angle from measuring direction to perpendicular.

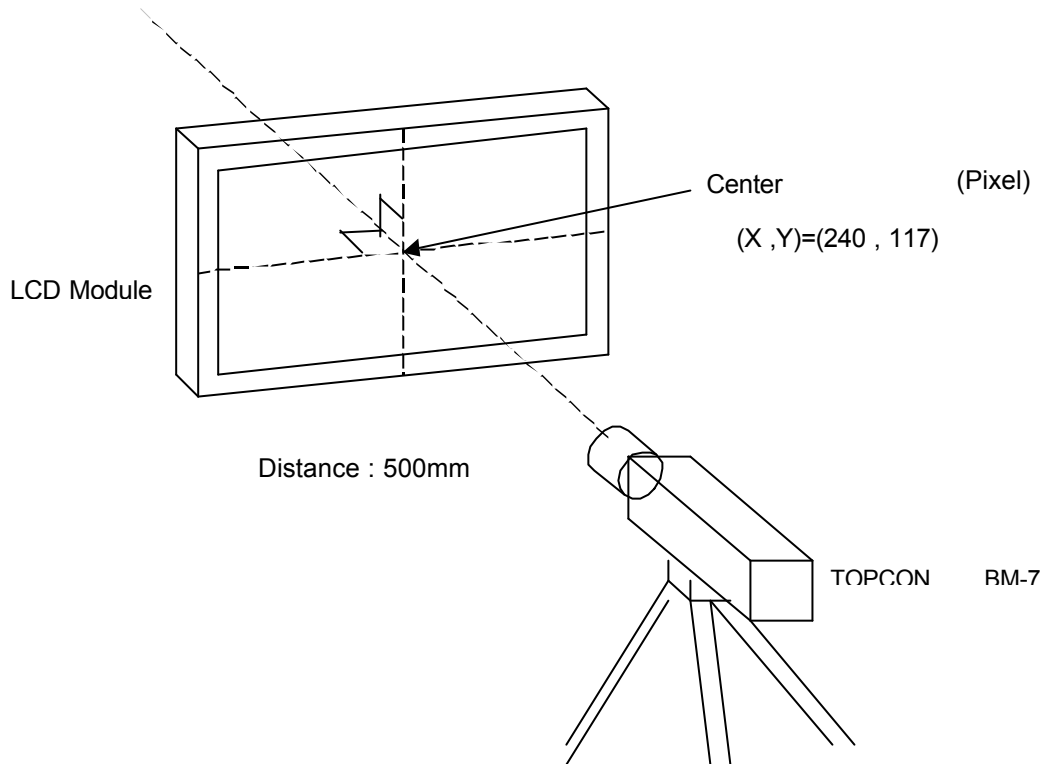

(3) Method of Measuring

Apply signal voltage (displayed in white) to maximize brightness and measure brightness B (cd/m²).

The distance between BM-7's front lens to surface panel is 500mm.

Measured after backlight has been lit for more than 30 minutes.

◆Method of Contrast Measurement

(1) Measuring Device
TOPCON BM-7, Measuring Field : 1°

(2) Measuring Point
Center of display: same as Method of Brightness Measurement

(3) Method of Measuring

- Set LCD module to $\theta=0^\circ$, $\phi=0^\circ$.
- Change signal voltage to measure maximum brightness Y1 and minimum brightness Y2.
- Contrast is derived from $CR=Y1/Y2$.

(Fig.5-2)

◆Definition of Brightness Uniformity

Definition is calculated from the four points (S0-S4) on the diagram below.

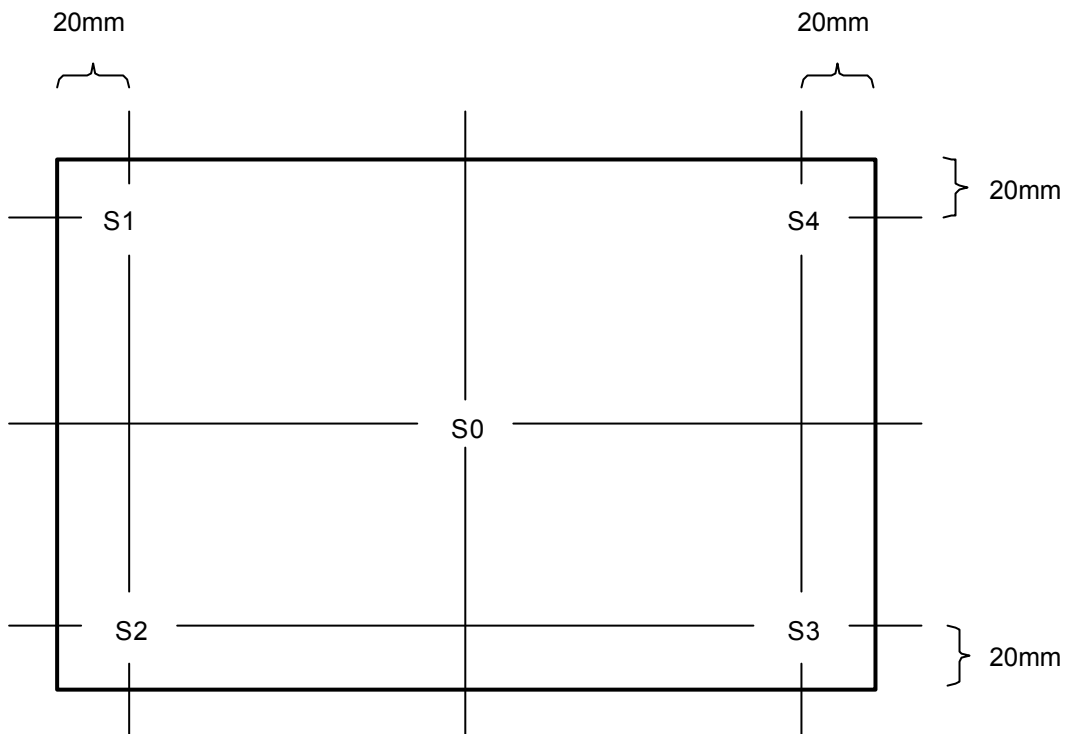

$$\text{Standard Value of Brightness Uniformity} = \frac{\text{Minimum Value of S1-S4}}{S0}$$

(Fig.5-3)

◆Method of Viewing Angle Measurement

(1) Measuring Device

TOPCON BM-7 , Measuring Field : 1°

(2) Measuring Point

Center of display : Same as Method of Brightness Measurement

(3) Angle of Measuring

θ : An angle vertical to perpendicular line from the viewing direction.

ϕ : An angle horizontal to perpendicular from the viewing direction.

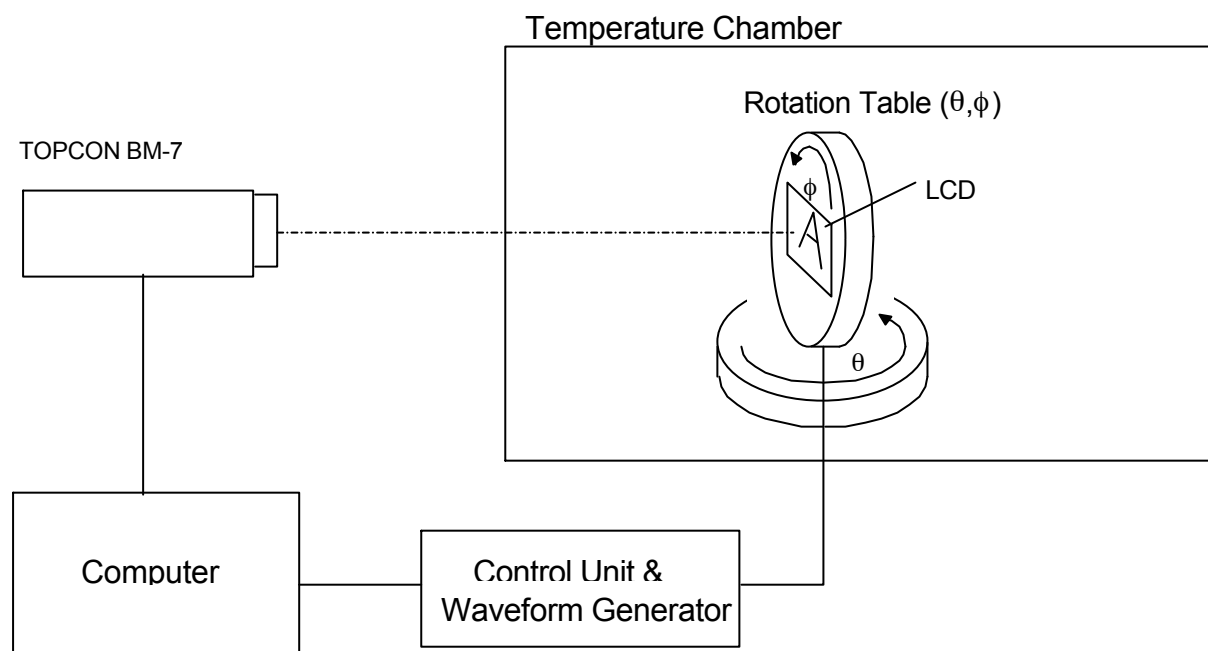

(4) Method of Measuring

Set rotation table to $\phi=0^\circ$ and set BM-7 to contrast 10 to measure angle $\pm\theta$ for left and right direction of horizontal viewing angle ϕ . Also set rotation table to $\phi=90^\circ$ and set BM-7 to contrast 10 to measure angle $\pm\theta$ for up and down direction of vertical viewing angle θ .

(Fig.5-4)

◆Measuring Response Time

(1) Measuring Device

TOPCON BM-7 , Measuring Field : 1°

Tektronix Digital Oscilloscope

(2) Measuring Point

Center of display, same as Method of Brightness Measurement

(3) Method of Measuring

- Set LCD panel to $\theta=0^\circ$, and $\phi=0^\circ$.
- Input white→black→white to display by switching signal voltage.
- If the luminance is 0% and 100% immediately before the change of signal voltage, then τ_r is optical response time during the change from 90% to 10% immediately after rise of signal voltage, and τ_d is optical response time during the change from 10% to 90% immediately after decay of signal voltage.

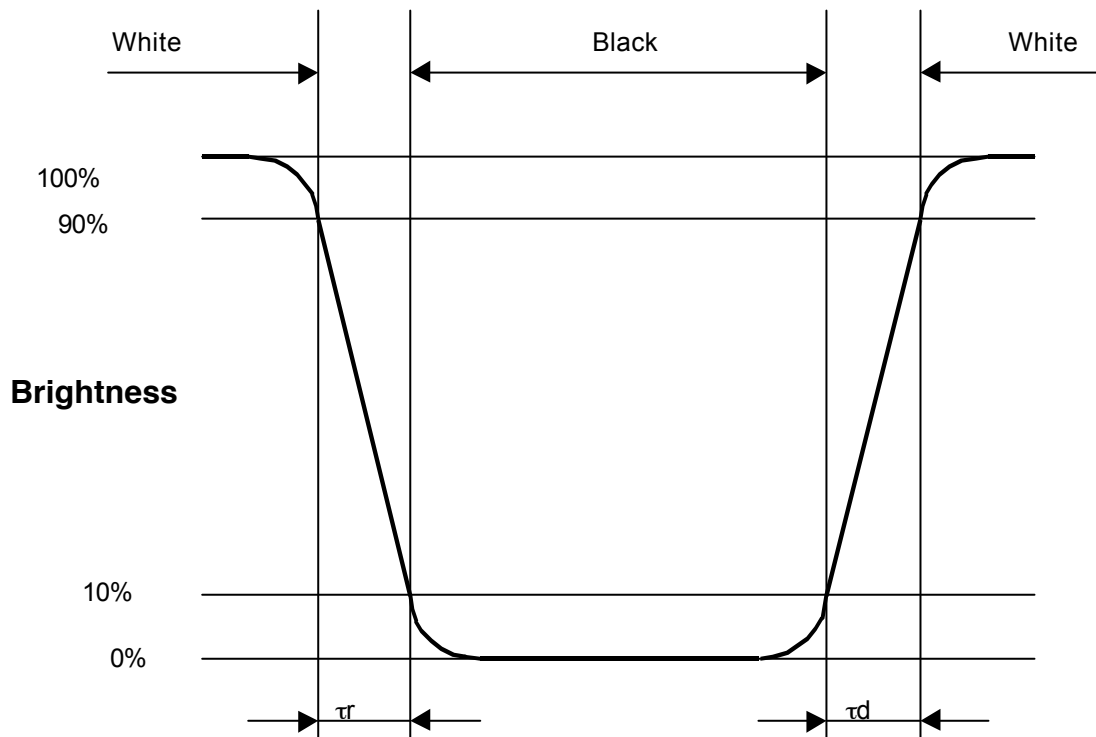

6. I/O Terminal

6.1.Pin Assignment

No.	Symbol	Level	Function	I/O	Remark
1	V _{DD}	-	Power Supply (+5V)	Output	
2	COLOR	-	Color Adjustment (0~5V)	Input	
3	BRT	-	Brightness Adjustment (0~5V)	Input	
4	CONT	-	Contrast Adjustment (0~5V)	Input	
5	VIDEO	-	Composite Video Signal Input (1.0V _{P-P} ,75Ω)	Input	
6	V _{SS}	-	Signal Ground	-	
7	V _{SS}	-	Backlight Ground	-	
8	V _{SS}	-	Backlight Ground	-	
9	V _{BL}	-	Power Supply for Backlight (+8~16V)	Input	
10	V _{BL}	-	Power Supply for Backlight (+8~16V)	Input	
11	U/D	H / L	Up/Down Scanning Direction (Open:Down to Up, GND:Up to Down)	Input	
12	R/L	H / L	Left/Right Scanning Direction (Open: Left to Right, GND: Right to Left)	Input	
13	DIM	-	Backlight Dimming (1~100% Adjustable)	Input	
14	MOD1	H / L	Display Mode 1	Input	
15	MOD2	H / L	Display Mode 2	Input	
16	MOD3	H / L	Display Mode 3	Input	
17	N/P	H / L	NTSC/PAL Select (Open : NTSC, GND : PAL)	Input	
18	TINT	-	Tint Adjustment (1.6~5V)	Input	
19	R/CMP	H / L	RGB/Composite Select (Open: RGB, GND:Composite)	Input	
20	YC/CMP	H / L	Synchronous Signal Select (Open: YC Separate, GND: Composite)	Input	
21	YCSYNC	-	Chroma Signal (0.7V _{P-P} ,75Ω)	Input	
22	VSY	-	Vertical Sync. (0.7V _{P-P} , Active Low)	Input	
23	HSY	-	Horizontal Sync. (0.7V _{P-P} , Active low)	Input	
24	V _{SS}	-	Signal Ground	-	
25	G	-	Green Color Video Signal (0.7V _{P-P} ,75Ω)	Input	
26	B	-	Blue Color Video Signal (0.7V _{P-P} ,75Ω)	Input	
27	R	-	Red Color Video Signal (0.7V _{P-P} ,75Ω)	Input	
28	V _{PW}	-	System Power Supply (+8~16V)	Input	
29	VSYO	-	Vertical Sync.Output (3.3V,Active Low)	Output	
30	HSYO	-	Horizontal Sync.Output (3.3V,Active Low)	Output	

Mating Connector : SHDR-30V-S-B (JST)

6.2. Block Diagram

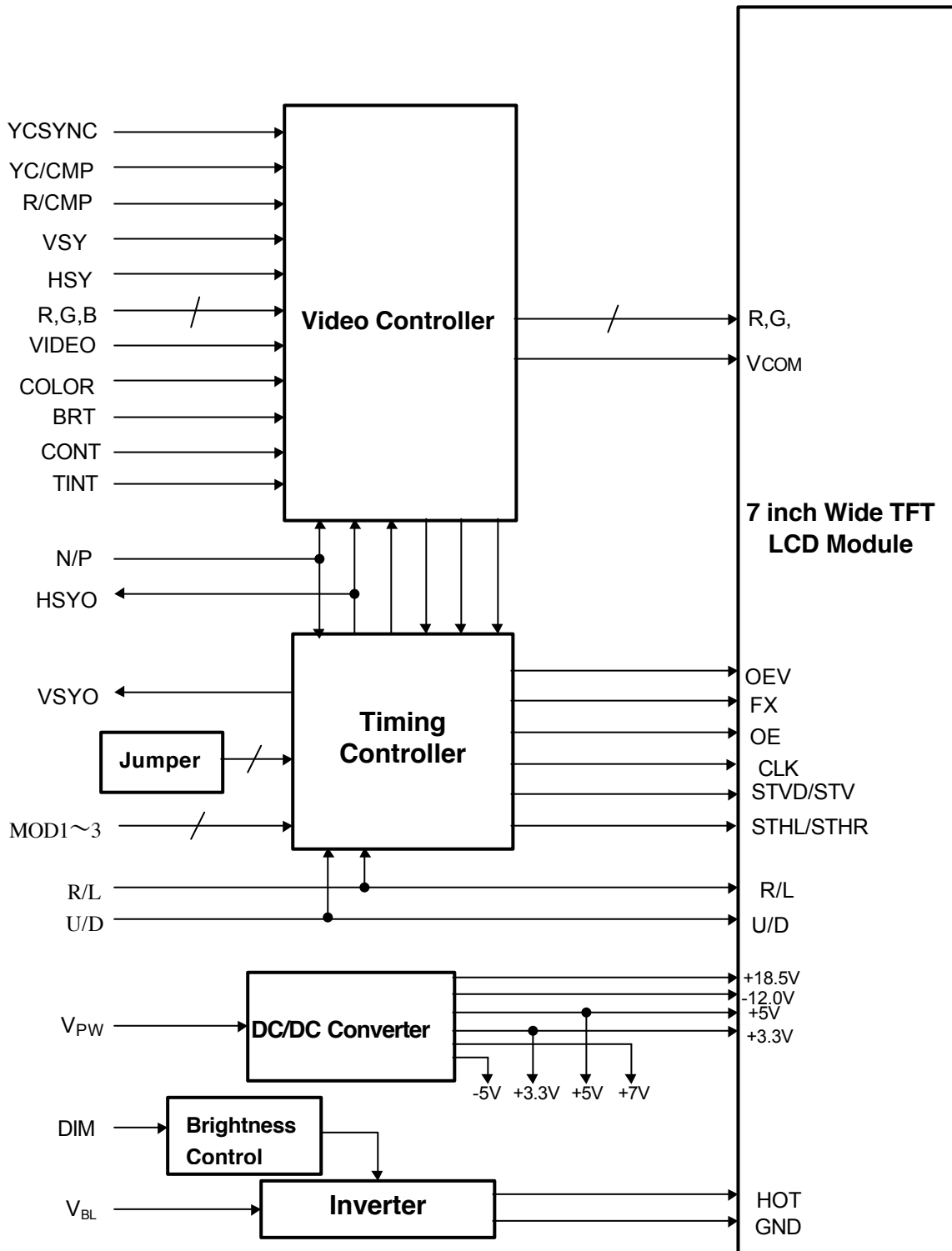

6.3.Signal Definition

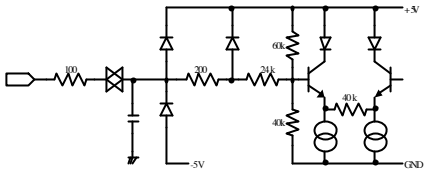
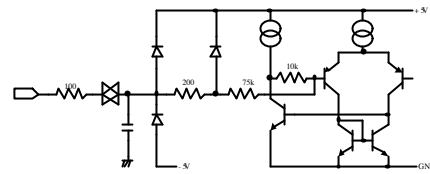
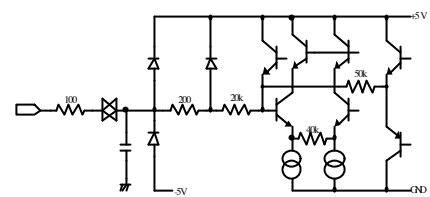
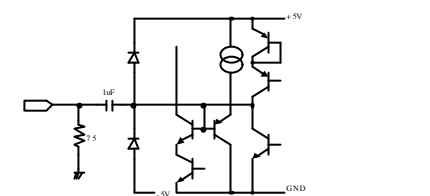
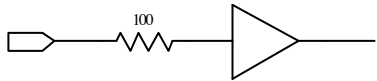
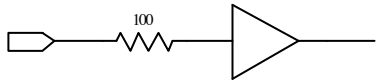
Pin No.	Symbol	Function	I/O Internal Equivalent Circuit
1	V _{DD}	5V output terminal Please use this for each adjustable terminal (2 ~ 4, 18 pin)	Output Current(I _{dd}) = Less than 10mA
2	COLOR	Color adjustment input terminal. Can be selected to change anywhere between 0 ~ 5V.	
3	BRT	Brightness Adjustment for RGB signal. Can be selected to change anywhere between 0 ~ 5V.	
4	CONT	Contrast adjustment terminal. Can be selected to change anywhere between 0 ~ 5V.	
5	VIDEO	Composite video signal input terminal. Please use standard input level 1 Vp-p of composite video signal. When using composite video input signal fix YCSYNC(21pin) to GND.	
6	V _{ss}	Signal Ground terminal. Connect to GND.	_____
7	V _{ss}	Backlight grounding terminal. Connect to GND.	_____
8	V _{ss}	Backlight grounding terminal. Connect to GND.	_____
9	V _{BL}	Power supply input terminal for backlight. Use standard 12V.	_____
10	V _{BL}	Power supply input terminal for backlight. Use standard 12V.	_____
11	U/D	Up/Down scanning direction select terminal. When open, it will scan down to up. When connected to GND, it will scan up to down.	
12	R/L	Left/Right scanning direction select terminal. When open, it will scan left to right. When connected to GND, it will scan right to left.	

Pin No.	Symbol	Function	I/O Internal Equivalent Circuit
13	DIM	Backlight Dimming Terminal. Input 3.3V square wave PWM format.	
14	MOD 1	Display mode select input terminal.	
15	MOD 2	See Table 6.1	
16	MOD 3		
17	N/P	NTSC/PAL select terminal. Open : NTSC GND : PAL	
18	TINT	Tint adjustment input terminal. Can be selected between 1~5V For PAL mode, the TINT pin tied to GND.	
19	R/CMP	Video signal input select terminal. Open: Analog RGB GND: Composite Video	
20	YC/CMP	Synchronous signal input select terminal. Open: YC separate input GND: Composite	
21	YCSYNC	Chroma input terminal. Use Chroma signal 0.7Vp-p. When using composite video, connect to GND.	
22	VSY	Vertical synchronous signal input terminal.	
23	HSY	Horizontal synchronous signal input terminal.	
24	Vss	Signal Ground terminal. Connect to GND.	
25	G	Analog RGB signal input terminal.	
26	B	Use Analog RGB signal standard level	
27	R	0.7Vp-p.	
28	PWR	System power supply input terminal. Use standard 12V.	
29	VSYO	Vertical synchronous signal output terminal. Please use for UOS(under on screen) to adjust the screen position.	
30	HSYO	Horizontal synchronous signal output terminal. Please use for UOS(under on screen) to adjust the screen position.	

Table 6.1 : Display Mode

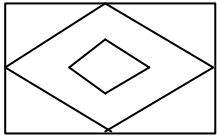
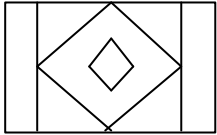
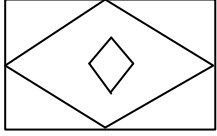
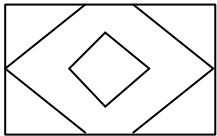
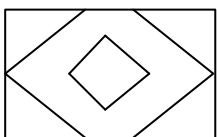
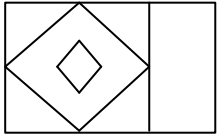
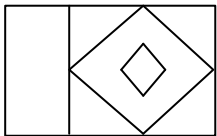
Mode	Display Image (4:3 Signal Input)	MOD1 (14pin)	MOD2 (15pin)	MOD3 (16pin)	Remark
Full		GND	GND	GND	Input Signal is displayed fully on screen.
Normal Center		OPEN	GND	GND	4:3 Image displayed in center of display.
Wide		GND	OPEN	GND	4:3 Signal has been extended sideways from center of display.
Zoom 1		OPEN	OPEN	GND	Display is fixed on top and then zoomed.
Zoom 2		GND	GND	OPEN	The time for gate is adjusted from Zoom1 mode.
Normal Left		OPEN	GND	OPEN	4:3 image shifted to left.
Normal Right		GND	OPEN	OPEN	4:3 image shifted to right.
Unfixed		OPEN	OPEN	OPEN	Invalid mode.

7. Test

7.1. Mechanical and Environmental Test

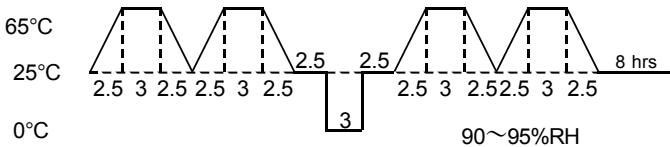
Item	Condition	Test hour	Remark	
Endurance	High temp operation	Ta=65±2°C, 45%RH Below	192 hrs	Note 1
	High temp & high humidity operation	Ta=65±2°C, 90±2%RH, No Condensation	192 hrs	Note 1
	Low temp operation	Ta=-30±3°C	192 hrs	Note 1
	High temp storage	Ta=85±2°C, 45%RH below	192 hrs	Note 1
	Low temp storage	Ta=-40±3°C	192 hrs	Note 1
	Light resistance	Sunshine carbon arc Ta=63±2°C	360 hrs	
Heat	Drastic temp change	-30°C(60min)⇔25°C(15min)⇔80°C(60min), No electric path	20 cycle	Note 2
	Condensation	-30°C(30min non-operating), 25°C/95%RH(10min operating) Dried after specified cycle and confirm operation	10cycle	
	Humidity cycle	1cycle=48hrs non-operational 	5cycle	
Electrical	Static resistance	C=200pF, R=0Ω, V=±150V 3 discharge on electric and other terminal, non-operational	-	
	Electric discharge	C=150pF, R=150Ω, V=±15kV Discharge ±charges 5 times each on panel and earth, non-Operational	-	
Mechanical	Vibration	5~10Hz, width 25mm 10~30Hz, 3.7×9.8m/s ² 30~50Hz, 1.6×9.8m/s ² 50~80Hz, 0.7×9.8m/s ² 80~100Hz, 0.3×9.8m/s ² } X,Y,Z all dir 8min×2sweep non-operational	All dir 1 hr	
	Shock	980m/s ² , t=6ms, X,Y,Z all dir, semi-sine-wave, non-operational	-	
	External durability	Apply pressure on the center of the screen by push / pull gauge. head diameter isφ12mm, pressured apply 5×9.8N(=5kgf) once, non-operational	-	
	Pressure resistance	5×10 ⁴ Pa(=0.5Pressure), non-operational	2 hrs	

Note 1: High temperature operation, high temperature & high humidity operation, low temperature operation, high temperature storage and low temperature storage will test it's ability for 1000 hours to confirm. The deterioration of plarizer is disregarded.

Note 2: Drastic tempertaure change test will continue the inspection under same condition consecutiely to confirm it's ability. Test will be done mounted in your request kit.

7.2. Reliability Test Standard

Item		Optical & Electrical Characteristics				Quality of Screen
		Contrast	Surface luminance	Response time	Circuit	
Endurance	High temp operation*	>30	within±20%	Within±20%	Within+40%	Not to be conspicuous
	High temp & high humidity operation*	>25	"	"	"	"
	Low temp operation*	>30	"	"	"	"
	High temp storage*	"	"	"	"	"
	Low temp storage*	"	"	"	"	"
	Light resistance*	"	"	"	"	"
Heat	Drastic temp change*	"	"	"	"	"
	Condensation**	>25	"	"	"	"
	Temp.& Humidity cycle**	"	"	"	"	"
Electrical	Static resistance	No abnormalities in system and display.				
	Electric discharge	No damage should be done				
Mechanical	Vibration	No abnormalities in system and display.				
	Shock	No abnormalities in system and display.				
	Exterior durability	No abnormalities in system and display.				
	Pressure durability	No abnormalities in system and display.				

Note : *indicates that test was performed in room temperature, more than 2 hours after it was taken out from chamber.

**indicates that test was performed after 24 hours after it has been taken out from chamber.

Luminance, circuit, response time changes are compared from the initial standard values.

8. Appearance Standard

8.1.Mechanical Testing

8.1.1. External appearance

Inspection Area	Item	Criteria	Remark
TFT Cell Section	Surface Linear Scratches	Thickness Disregard under 0.05mm Between 0.05mm-0.15mm, total length must be within 50mm Greater then 0.15mm is not acceptable	Note1 Note2
	Surface Spot Scratches	Disregard under 1 sub-pixel Penalized for 1-3 sub-pixels Shall not exceed 3 sub-pixels	
	Back Scratches	Observe from surface and judge based on criteria of surface	
	Chipped	It must not influence surface	
	Dirt	Must be removable	
	Discoloration	No irregular discoloration on screen	
Metal Shield case (Applies to all surface)	Linear Scratches	Thickness Disregard under 3.0mm Greater then 3.0mm must have less then 90mm total	Note2
	Spot Scratches	Diameter Less then 3.0mm ϕ , only 3 is allowed Greater then 3.0mm ϕ is not accepted	
	Dirt	Must be removable	
	Deformation	Not allowed	
	Fingerprint	Remove as much as possible	
Input Output Section (FPC w/B/L Cable)	Crack	No crack or disconnection	Note3
	Distortion	No noticeable distortion	
	FPC tape	The FPC should not be coming off for more then 10mm	

Note1: Cell section's area subject to quality display area. Quality display area is specified in the external appearance drawing.

Note2: If there are any other problems please follow "Precautions under operation".

Note3: This is provisional standard and applies to limited sample (Optrex standards)

8.1.2. Dimensional Outline

All standards follow the measurement designated by the dimensional outline drawing.

8.2. Quality of Display

8.2.1. Conditions for Common Inspection

Unless specified, the conditions below will be applied.

$T_a=25\pm 5^{\circ}\text{C}$, Humidity=65%, $V_{PW}=V_{BL}=+12.0\text{V}$, $V_{SS}=0\text{V}$, Backlight inverter=Our standard inverter or equivalent, measured after backlight has been lit for more than 30 minutes.

8.2.2. Quality Display Standard and Criteria for Judgement

(A) Quality Display Standard

Item		Description	Criteria
Quality Display	Line defect	Black, white and colored line	Not accepted
	Spot defect	Lighting irregularities due to sub-pixels by the TFT and CF. White spots : Any pixel that can be seen through ND(Neutral Density) filter when black signal($V_{sig}=4\text{V}$) is inputted under specified condition. Black spots : Any pixel that is below 50% of maximum luminance when white signal($V_{sig}=0\text{V}$) is inputted.	Refer to next Section Note 2
Quality Screen	Stain	Luminance irregularities and discoloration spots.	Note 1,2
	Irregularity	Same as stain with more area.	
	Line	Same as stain but in linear shape.	
	Stripe	Same as stain, but in arc, spirals, or moiré shape.	
	Reverse	Others that are formed from concentration of irregular patterns.	

Note1: The quality of screen is set at $V_{sig}=0\text{V}$ (white), 2V (middle), 4V (black) screen display and it may not be seen through 2.5% ND filter. However, for few exceptions, Sample under Optrex standard will be used for inspection.

Note2: When questions arise concerning this specifications or new problems that are not specified, it will be discussed for solution.

(B) Spot Defect Inspection Standards and Criteria.

White spots inspection criteria

Include below with the 8.2.1.conditions for common inspection

Luminance : 200~250 [lx]
Distance : 45~50 [cm] (Perpendicular from panel surface)
Time : 5 [S] (After ND filter has been placed)
Surface Brightness : 300~320 [cd/m²]

Standard

Type	Acceptable No.	Criteria
Level 1 White Spots	0	Visible through 0.3%ND filter
Level 1-2 White Spots	3	Visible through 1.0%ND filter, and not visible through 0.3%ND filter
Level 1-3 White Spots	5	Visible through 2.5%ND filter, and not visible through 1.0%ND filter
Black spots	6	Any visible black spots on V _{sig} =1V(All white cluster)
Total	7	Total white and black spots in level 1-3

Any spots that are not visible through 2.5% ND filters and not within level 1-3 is disregarded.

◎ Density:

Only up to 2(white or black) are allowed for diameter within ϕ 10mm.
If it is continuous, then continuous spot is applied.

◎ Continuous spot :

Any spot that continues for more than 3 pixels is not acceptable.
For 2 continuous white spots, treat as one spot for the table above.
For 2 continuous black spots, treat as two spots for the table above.
For 2 continuous white and black spot, treat as one each.

◎ White & black spot:

If the pixel holds both white and black spot (level 1-3), treat as white spot for the table above.

◎ Foreign Substance(within Cell):

Foreign substance shall not be more than 3-pixel size.
If the size of substance is 2 to 3-pixel, then count as 2 in acceptable value.
If the size of substance is 1 to 2-pixel, then count as 2 in acceptable value.
If the size of substance is smaller than 1 pixel, then disregard.

9. Code System of Production Lot

The production lot of module is specified as follows.

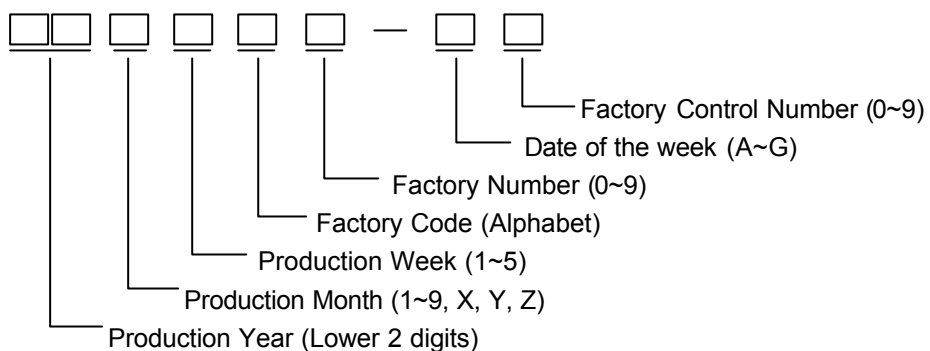

10. Type Number

The type number of module is specified as follows.

T-51440GL070H-FW-AF

11. Applying Precautions

Please contact us when questions and/or new problems not specified in this Specifications arise.

12. Precautions Relating Product Handling

The Following precautions will guide you in handling our product correctly.

- 1) Liquid crystal display devices
 1. The liquid crystal display device panel used in the liquid crystal display module is made of plate glass. Avoid any strong mechanical shock. Should the glass break handle it with care.
 2. The polarizer adhering to the surface of the LCD is made of a soft material. Guard against scratching it.
- 2) Care of the liquid crystal display module against static electricity discharge.
 1. When working with the module, be sure to ground your body and any electrical equipment you may be using. We strongly recommend the use of anti static mats (made of rubber), to protect work tables against the hazards of electrical shock.
 2. Avoid the use of work clothing made of synthetic fibers. We recommend cotton clothing or other conductivity-treated fibers.
 3. Slowly and carefully remove the protective film from the LCD module, since this operation can generate static electricity.
- 3) When the LCD module alone must be stored for long periods of time:
 1. Protect the modules from high temperature and humidity.
 2. Keep the modules out of direct sunlight or direct exposure to ultraviolet rays.
 3. Protect the modules from excessive external forces.
- 4) Use the module with a power supply that is equipped with an overcurrent protector circuit, since the module is not provided with this protective feature.
- 5) Do not ingest the LCD fluid itself should it leak out of a damaged LCD module. Should hands or clothing come in contact with LCD fluid, wash immediately with soap.
- 6) Conductivity is not guaranteed for models that use metal holders where solder connections between the metal holder and the PCB are not used. Please contact us to discuss appropriate ways to assure conductivity.
- 7) For models which use CFL:
 1. High voltage of 1000V or greater is applied to the CFL cable connector area. Care should be taken not to touch connection areas to avoid burns.
 2. Protect CFL cables from rubbing against the unit and thus causing the wire jacket to become worn.
 3. The use of CFLs for extended periods of time at low temperatures will significantly shorten their service life.
- 8) For models which use touch panels:
 1. Do not stack up modules since they can be damaged by components on neighboring modules.
 2. Do not place heavy objects on top of the product. This could cause glass breakage.
- 9) For models which use COG, TAB, or COF:
 1. The mechanical strength of the product is low since the IC chip faces out unprotected from the rear. Be sure to protect the rear of the IC chip from external forces.
 2. Given the fact that the rear of the IC chip is left exposed, in order to protect the unit from electrical damage, avoid installation configurations in which the rear of the IC chip runs the risk of making any electrical contact.

10) Models which use flexible cable, heat seal, or TAB:

1. In order to maintain reliability, do not touch or hold by the connector area.
2. Avoid any bending, pulling, or other excessive force, which can result in broken connections.

11) In case of buffer material such as cushion / gasket is assembled into LCD module, it may have an adverse effect on connecting parts (LCD panel-TCP / HEAT SEAL / FPC / etc., PCB-TCP / HEAT SEAL / FPC etc., TCP-HEAT SEAL, TCP-FPC, HEAT SEAL-FPC, etc.) depending on its materials.

Please check and evaluate these materials carefully before use.

12) In case of acrylic plate is attached to front side of LCD panel, cloudiness (very small cracks) can occur on acrylic plate, being influenced by some components generated from polarizer film..

Please check and evaluate those acrylic materials carefully before use.

13. Warranty

This product has been manufactured to your company's specifications as a part for use in your company's general electronic products. It is guaranteed to perform according to delivery specifications. For any other use apart from general electronic equipment, we cannot take responsibility if the product is used in medical devices, nuclear power control equipment, aerospace equipment, fire and security systems, or any other applications in which there is a direct risk to human life and where extremely high levels of reliability are required. If the product is to be used in any of the above applications, we will need to enter into a separate product liability agreement.

1. We cannot accept responsibility for any defect, which may arise from additional manufacturing of the product (including disassembly and reassembly), after product delivery.
2. We cannot accept responsibility for any defect, which may arise after the application of strong external force to the product.
3. We cannot accept responsibility for any defect, which may arise due to the application of static electricity after the product has passed your company's acceptance inspection procedures.
4. When the product is in CFL models, CFL service life and brightness will vary according to the performance of the inverter used, leaks, etc. We cannot accept responsibility for product performance, reliability, or defect, which may arise.
5. We cannot accept responsibility for intellectual property of a third party, which may arise through the application of our product to your assembly with exception to those issues relating directly to the structure or method of manufacturing of our product.
6. Optrex will not be held responsible for any quality guarantee issue for defect products judged as Optrex-origin longer than 2 (two) years from Optrex production or 1(one) year from Optrex, Optrex America, Optrex Europe delivery which ever comes later.