

(

2

0

<

?

(

(

>

!

!

!

!

# 9

5	7	<
)	9	#
)	9	%
#	4	&
%	>	+
&	4	*
+	6	*
*	7	-
,	7	U
-	Q	#
0	S	#
U	>	#
#	?	#
#	>	%
#	:	%

!

!

!

!

!

!

!

!

D  
(  
M

!

!

!

!

G

7	;	S	S	R	
!	8	! /	+	8	
!	8	! /	,	8	
!	7	/	#	M	
!	5	( F	! &	0	d
!	5	( F	! &	0	d
;	5	( X	! &	0	d

e

#  
% ( u! "9 "9 z "9

@  
"

7	;	S	(	S	R	?
<	8	&	&	&	8	k
<	7	)	&	*	M	k
<	8	)	)	#	M	8
2	:	8	%	)	*	8
8	2	8	/	)	/	8

k

C u# 'M  
/ u!  
/ u!

% uC  
% uC  
/ uC

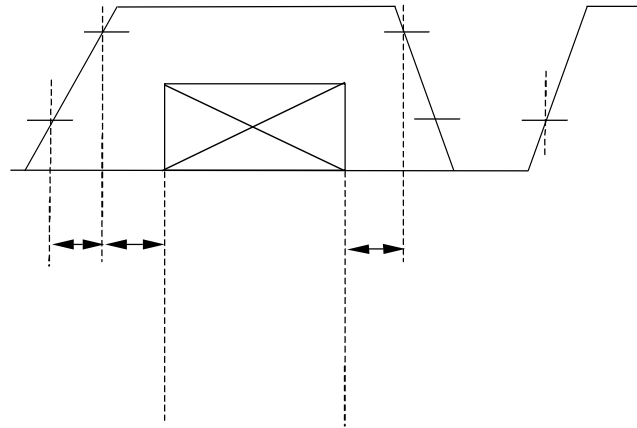

! ! ! !

8

#

u!

u!

%

8

!

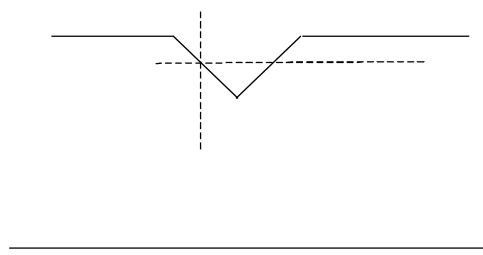

!

!

!

!

]

!

!

!

!

!

O  
"

R  
9

<	;	=
#	T	
%	.	9
&	:	:
+	8	8
*	T	
,	?	?

!

!

!

!



"

!

!

!

!

Q

"

7		;	S	(	S	R	
.	=	`9	%	%	&	S	
	<	G	&	+	*	N	
	2	G <sub>3</sub>	#	)	)	N	
	:	G <sub>3</sub>	#	)	)	N	
.	:	C	+	)	)	N	
	:	C	+	)	)	N	
.	:	4	C	,	,	G <sub>9</sub>	
		Q	C	%	#	)	G <sub>9</sub>
		=	`:	%	&	&	b
		<	C	%	&	&	aX
	8	4	G <sub>8</sub>	+	+	+	C
		Q	G <sub>8</sub>	+	+	)	C
		=	`8	*	,	-	:
		<	G <sub>8</sub>	#	#	#	M

e

#

%

&

+

G i 8 ! & ; '

!

!

!

!

"

!



!

!

!

!

"

9	7																	
	?	?	?	?	?	?	T	T	T	T	T	T	Q	Q	Q	Q	Q	Q
	S					2	S					2	S					2

!

!

!

!

"

.

;

!

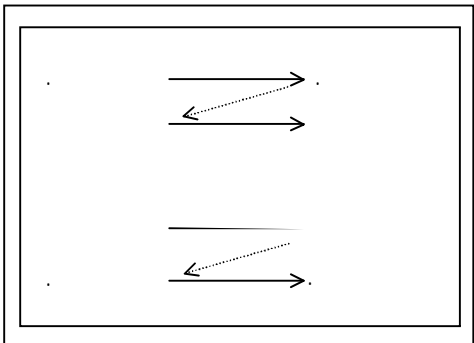

!

!

!

!

R

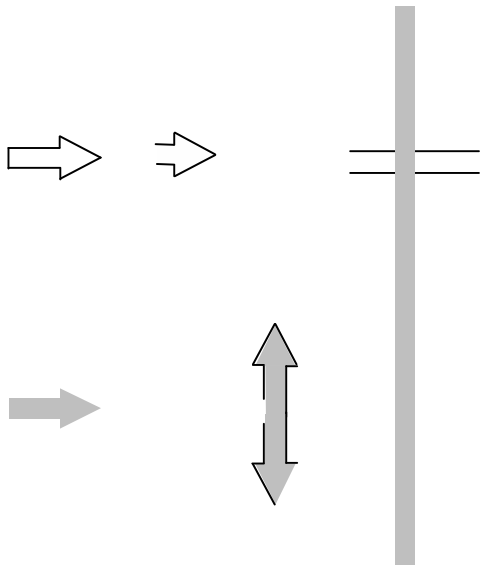

!

!

!

!

?



!

!

!

!

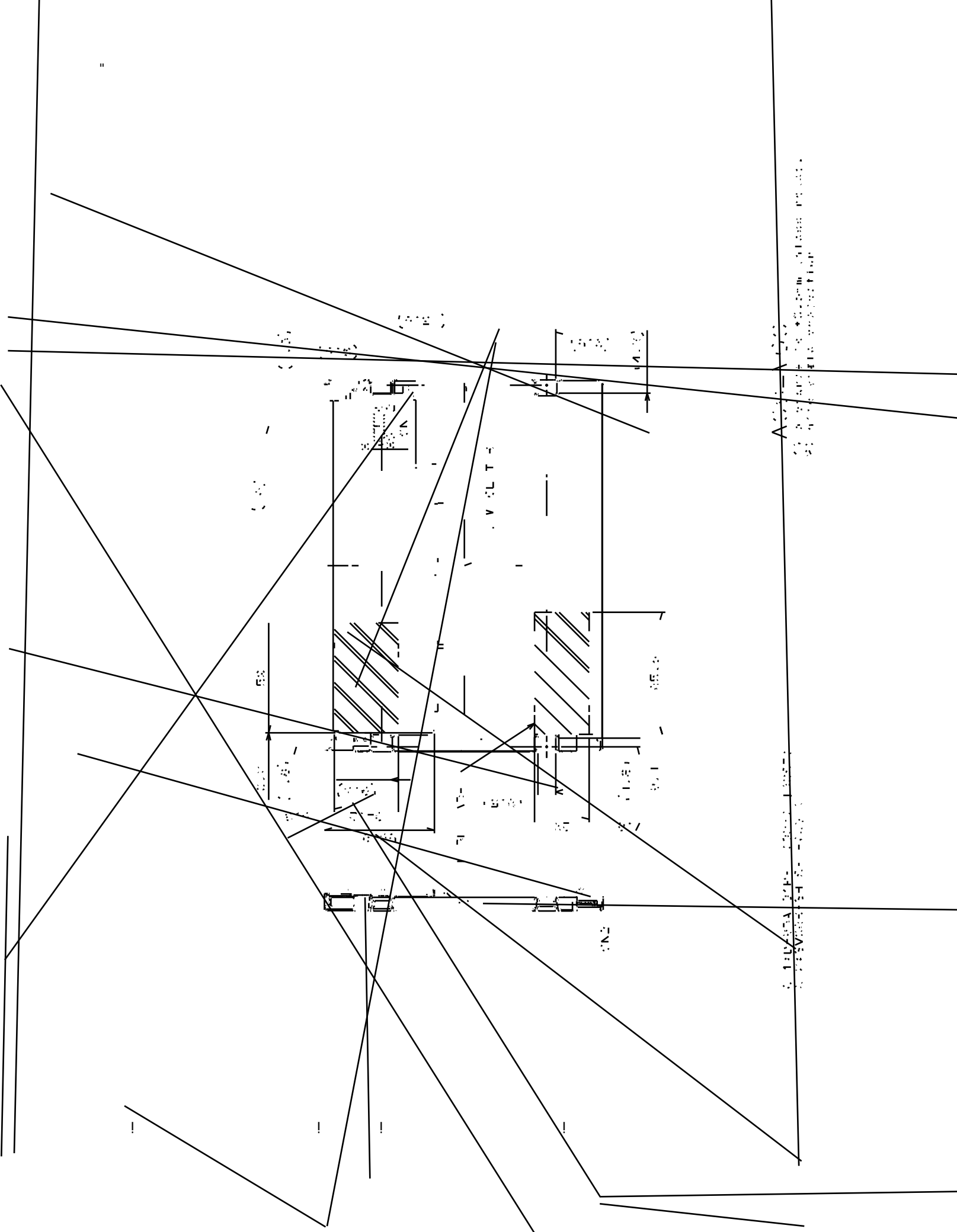

(1.7)

(1.8)

VALVE

6.50

6.50

1.00

1.10



U

	7	;	9	S	(	S	R	?
9		9	e8					

!

!

!

!

k

9  
2

r\*

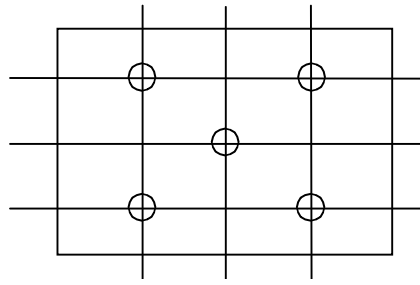

k

9

k

82

#

k

3



U

U

2

C

⌒ #

Q

#

C

!

!

!

!

k

9

Z

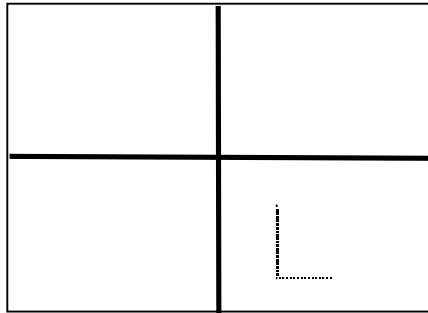

!

!

!

!

V

"

(	9
:	+
:	"
:	0

2

!

!

!

!

V

(

k!

k!

D

!

!

!

!

V

<

Z

B

"

<

a

"

M

!

!

!

!



^

^

Z

B

F

2

a

-

Z

!

!

!

!