

TENTATIVE

All information in this technical data sheet is tentative
and subject to change without notice.

12.1" SVGA

TECHNICAL SPECIFICATION

COMPANY PROPRIETARY
NOT TO BE REPRODUCED OR DISCLOSED WITHOUT SPECIFIC
WRITTEN PERMISSION OF MITSUBISHI ELECTRIC CORPORATION
(THIS IS A RED INK STAMP)

AA121SL09

mitsubishi ELECTRIC Corp.

Date: Feb.7,'08

CONTENTS

No.	Item	Page
--	COVER	1
--	CONTENTS	2
1	APPLICATION	3
2	OVERVIEW	4
3	ABSOLUTE MAXIMUM RATINGS	5
4	ELECTRICAL CHARACTERISTICS	5, 6, 7
5	INTERFACE PIN CONNECTION	8, 9
6	INTERFACE TIMING	10, 11, 12, 13
7	BLOCK DIAGRAM	14
8	MECHANICAL SPECIFICATION	15, 16
9	OPTICAL CHARACTERISTICS	17, 18, 19
10	RELIABILITY TEST CONDITION	20
11	OTHER FEATURE	21
12	HANDLING PRECAUTIONS FOR TFT-LCD MODULE	22, 23, 24

1. APPLICATION

This specification applies to color TFT-LCD module, AA121SL09.

These specification papers are the proprietary product of Mitsubishi Electric Corporation (“MITSUBISHI”) and include materials protected under copyright of MITSUBISHI. No part of this document may be reproduced in any form or by any means without the express written permission of MITSUBISHI.

MITSUBISHI does not assume any liability for infringement of patents, copyrights or other intellectual property rights of third parties by or arising from use of a product specified in this document. No license, express, implied or otherwise, is granted under any patents, copyrights or other intellectual property rights of MITSUBISHI or of others.

MITSUBISHI classifies the usage of the TFT-LCD module as follows. Please confirm the usage before using the product.

(1) Standard Usage

Computers, office equipment, factory automation equipment, test and measurement equipment, communications, transportation equipment(automobiles, ships, trains, etc.), provided, however, that operation is not influenced by TFT-LCD directly.

(2) Special Usage

Medical equipment, safety equipment, transportation equipment, provided, however, that TFT-LCD is necessary to its operation.

(3) Specific Usage

Cockpit Equipment, military systems, aerospace equipment, nuclear reactor control systems, life support systems and any other equipment. MITSUBISHI should make a contract that stipulate apportionment of responsibilities between MITSUBISHI and our customer.

The product specified in this document is designed for “Standard Usage” unless otherwise specified in this document. If customers intend to use the product for applications other than those specified for “Standard Usage”, they should first contact MITSUBISHI sales representative for it's intended use in writing.

MITSUBISHI has been making continuous effort to improve the reliability of its products. Customers should implement sufficient reliability design of their application equipments such as redundant system design, fail-safe functions, anti-failure features.

MITSUBISHI assumes no responsibility for any damage resulting from the use of the product that does not comply with the instructions and the precautions specified in this document.

Please contact and consult a MITSUBISHI sales representative for any questions regarding this product.

2. OVERVIEW

AA121SL09 is 12.1" color TFT-LCD (Thin Film Transistor Liquid Crystal Display) module composed of LCD panel, driver ICs, control circuit, and backlight unit.

By applying 6 bit digital data, 800 × 600, 262k-color images are displayed on the 12.1" diagonal screen. Input power voltage is single 3.3V for LCD driving.

The type of data and control signals are digital and transmitted via CMOS interface per Typ. 40 MHz clock cycle.

Inverter for backlight is not included in this module. General specifications are summarized in the following table:

ITEM	SPECIFICATION
Display Area (mm)	246.0(H) × 184.5(V) (12.106-inch diagonal)
Number of Dots	800 × 3 (H) × 600 (V)
Pixel Pitch (mm)	0.3075 (H) × 0.3075 (V)
Color Pixel Arrangement	RGB vertical stripe
Display Mode	Normally white TN
Number of Color	262k
Luminance (cd/m ²)	400
Wide Viewing Angle Technology	Optical Compensation Film
Surface Treatment	Anti-glare and hard-coating 3H
Viewing Angle (CR ≥ 10)	-65~65° (H) -75~45° (V)
Electrical Interface	CMOS
Optimum Viewing Angle (Contrast ratio)	6 o'clock
Module Size (mm)	280.0 (W) × 210.0 (H) × 12.0 (D)
Module Mass (g)	720
Backlight Unit	CCFL, 2-tubes, edge-light, replaceable

Characteristic value without any note is typical value.

3. ABSOLUTE MAXIMUM RATINGS

ITEM	SYMBOL	MIN.	MAX	UNIT
Power Supply Voltage for LCD	VCC	-0.3	4.0	V
Logic Input Voltage	VI	-0.3	6.0	V
Lamp Voltage	VL	0	2000	Vrms
Lamp Current	IL	0	18	mArms
Lamp Frequency	FL	--	100	kHz
Operation Temperature (Panel) <small>Note 1,2)</small>	T _{op(Panel)}	-20	70	°C
Operation Temperature (Ambient) <small>Note 2)</small>	T _{op(Ambient)}	-20	70	°C
Storage Temperature <small>Note 2)</small>	T _{stg}	-20	80	°C

[Note]

1) Measured at the center of active area and at the center of panel back surface

2) Top, Tstg ≤ 40°C : 90%RH max. without condensation

Top, Tstg > 40°C : Absolute humidity shall be less than the value of 90%RH at 40°C without condensation.

4. ELECTRICAL CHARACTERISTICS

(1) TFT-LCD

Ambient temperature: Ta = 25°C

ITEM	SYMBOL	MIN.	TYP.	MAX.	UNIT	Remarks
Power Supply Voltage for LCD	VCC	3.0	3.3	3.6	V	*1)
Power Supply Current for LCD	ICC	--	340	500	mA	*2)
Permissible Input Ripple Voltage	VRP	--	--	100	mVp-p	VCC = +3.3V
Logic Input Voltage	High	VIH	2.0	--	5.5	V
	Low	VIL	0	--	0.8	V

*1) Power and signals sequence:

$t_1 \leq 10 \text{ ms}$ $200 \text{ ms} \leq t_4$
 $0 < t_2 \leq 50 \text{ ms}$ $200 \text{ ms} \leq t_5$
 $0 < t_3 \leq 50 \text{ ms}$ $0 \leq t_6$

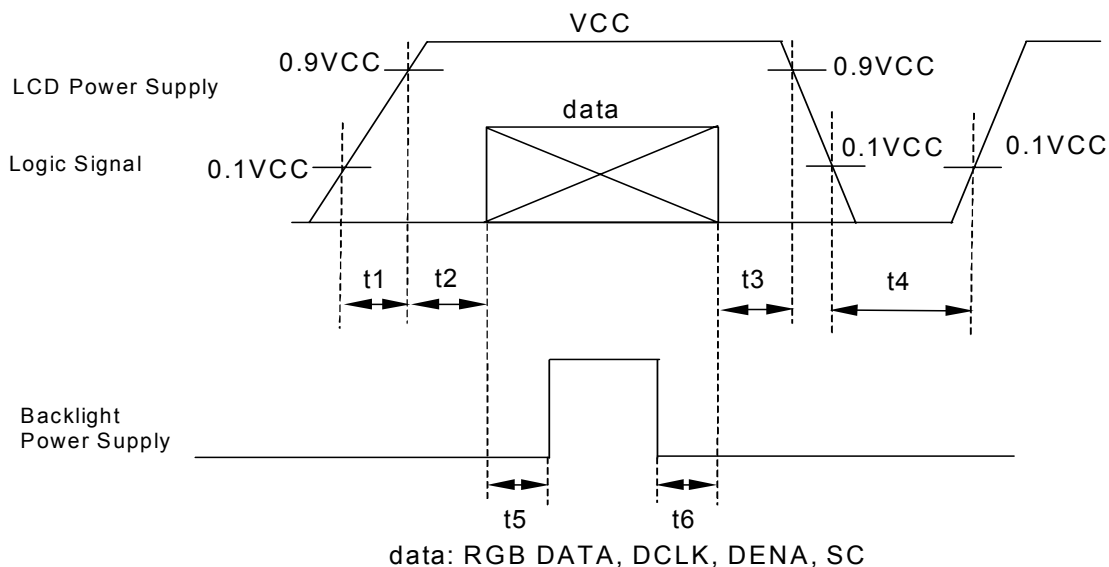

VCC-dip conditions:

- 1) When $2.4\text{ V} \leq \text{VCC} < 3.0\text{ V}$, $t_d \leq 10\text{ ms}$
- 2) When $\text{VCC} < 2.4\text{ V}$

VCC-dip conditions should also follow the power and signals sequence.

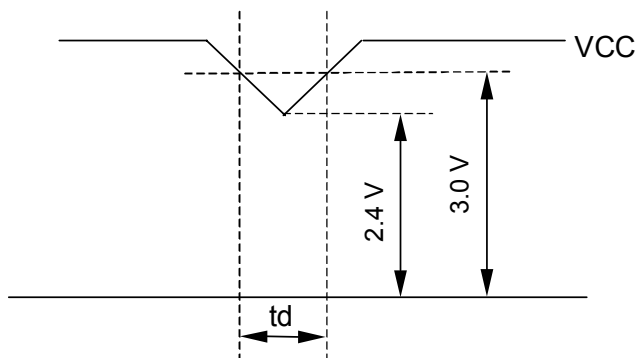

*2) $\text{VCC} = + 3.3\text{ V}$, $f_H=37.9\text{kHz}$, $f_V=60\text{Hz}$, $f_{\text{CLK}}= 40\text{MHz}$

Display image of typical is 64-gray-bar pattern (6 bit), 600 line mode.

*3) Fuse

Parameter	Fuse Type Name	Supplier	Remark
VCC	FCC16162AB	Kamaya Electric Co., Ltd.	*)

*) The power supply capacity should be designed to be more than the fusing current.

(2) Backlight

$T_a = 25^\circ\text{C}$

ITEM	SYMBOL	MIN.	TYP.	MAX.	UNIT	Remarks
Lamp Voltage	VL	--	540	--	Vrms	IL = 12.0 mArms
Lamp Current	IL	6.0	12.0	14.0	mArms	*2),*6)
Lamp Frequency	FL	30	--	70	kHz	*3)
Starting Lamp Voltage	VS	1000	--	--	Vrms	$T_a = 25^\circ\text{C}$
		1200	--	--		$T_a = 0^\circ\text{C}$
		1290	--	--		$T_a = -20^\circ\text{C}$
Lamp Life Time	LT	50,000	--	--	h	*4),*5) IL = 12.0 mArms Continuous operation

[Note]

*1) Please use synchronous inverter.

*2) Lamp Current measurement method (The current meter is inserted in low voltage line.)

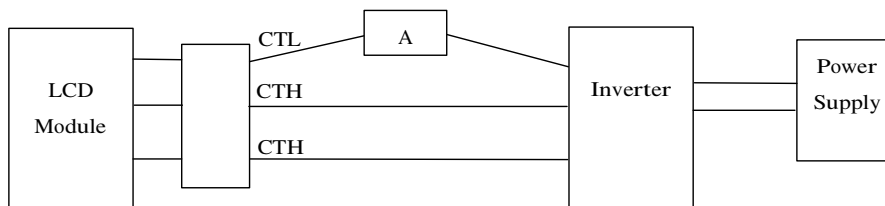

*3) Lamp frequency of inverter may produce interference with horizontal synchronous frequency, and this may cause horizontal beat on the display. Therefore, please adjust lamp frequency, and keep inverter as far from module as possible or use electronic shielding between inverter and module to avoid the interference.

- *4) Lamp life time is defined as the time either when the brightness becomes 50% of the initial value, or when the starting lamp voltage does not meet the value specified in this table.
- *5) The life time of the backlight depends on the ambient temperature. The life time will decrease under low/high temperature.
- *6) Please use the inverter which has symmetrical current wave form as follows,

The degree of unbalance: less than 10%

The ratio of wave height: less than $\sqrt{2} \pm 10\%$

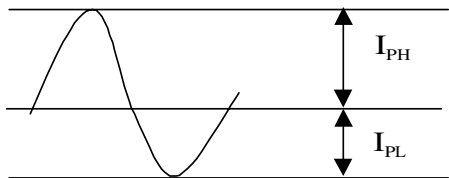

I_{PH} : High side peak

I_{PL} : Low side peak

The degree of unbalance = $|I_{PH} - I_{PL}| / I_{rms} \times 100(\%)$
 The ratio of wave height = $I_{PH}(\text{or } I_{PL}) / I_{rms}$

CURRENT WAVE FORM

5. INTERFACE PIN CONNECTION

(1) CN 1(INTERFACE SIGNAL)

Used connector: DF9B-41P-1V(32) (Hirose)

Corresponding connector: DF9B-41S-1V (Hirose)

Pin No.	Symbol	Function
1	GND	Signal ground
2	DCLK	Clock signal for sampling catch data signal
3	GND	Signal ground
4	HD	Horizontal sync signal *1)
5	VD	Vertical sync signal *1)
6	GND	Signal ground
7	GND	Signal ground
8	GND	Signal ground
9	R0	RED data signal(LSB)
10	R1	RED data signal
11	R2	RED data signal
12	GND	Signal ground
13	R3	RED data signal
14	R4	RED data signal
15	R5	RED data signal(MSB)
16	GND	Signal ground
17	GND	Signal ground
18	GND	Signal ground
19	G0	GREEN data signal(LSB)
20	G1	GREEN data signal
21	G2	GREEN data signal
22	GND	Signal ground
23	G3	GREEN data signal
24	G4	GREEN data signal
25	G5	GREEN data signal(MSB)
26	GND	Signal ground
27	GND	Signal ground
28	GND	Signal ground
29	B0	BLUE data signal (LSB)
30	B1	BLUE data signal
31	B2	BLUE data signal
32	GND	Signal ground
33	B3	BLUE data signal
34	B4	BLUE data signal
35	B5	BLUE data signal(MSB)
36	GND	Signal ground
37	DENA	Data enable signal(to settle the viewing area)
38	GND	Signal ground
39	VCC	+3.3 V Power supply
40	VCC	+3.3 V Power supply
41	SC	Scan direction control.(Low:Normal, High:Reverse)

*1) HD and VD are not being used for timing control.

*2) Metal frame is connected to signal GND.

(2)CN 2(BACKLIGHT)

Backlight-side connector: BHR-04VS-1 (JST)

Inverter-side connector: SM04(4.0)B-BHS(LF)(SN) (JST)

Pin No.	Symbol	Function
1, 2	CTH	VBLH (High voltage)
4	CTL	VBLL (Low voltage)

[Note] $VBLH - VBLL = VL$

6. INTERFACE TIMING

(1) Timing Specifications

ITEM		SYMBOL	MIN.	TYP.	MAX.	UNIT	
DCLK	Frequency	f _{CLK}	35	40	42	MHz	
	Period	t _{CLK}	23.8	25	28.6	ns	
	Low Width	t _{WCL}	10	--	--	ns	
	High Width	t _{WCH}	10	--	--	ns	
DATA(R,G,B), DENA	Set up time	t _{DS}	4	--	--	ns	
	Hold time	t _{DH}	4	--	--	ns	
DENA	Horizontal	Active Time	t _{HA}	800	800	800	t _{CLK}
		Blanking Time	t _{HB}	20	256	--	t _{CLK}
		Frequency	f _H	35.2	37.9	39.2	kHz
		Period	t _H	25.5	26.4	28.4	μs
	Vertical	Active Time	t _{VA}	600	600	600	t _H
		Blanking Time	t _{VB}	4	28	--	t _H
		Frequency	f _V	55	60	64.2	Hz
		Period	t _V	15.6	16.7	18.2	ms

[Note]

- 1) DATA is latched at fall edge of DCLK in this specification.
- 2) DENA (Data Enable) should always be positive polarity as shown in the timing specification.
- 3) DCLK should appear during all invalid period.
- 4) In case of blanking time fluctuation, please satisfy following condition.

$$t_{VBn} > t_{VBn-1} - 3(t_H)$$

(2) Timing Chart

a. Pixel Timing Chart

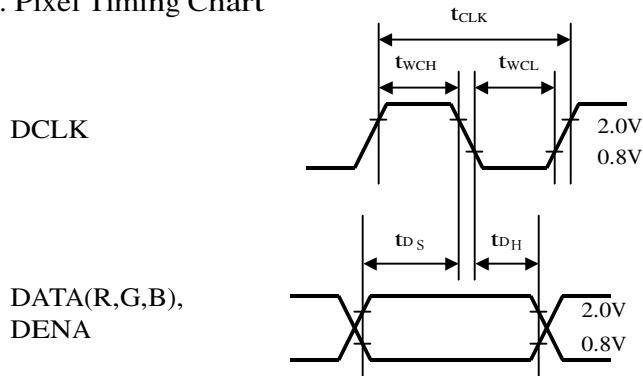

b. Horizontal Timing Chart

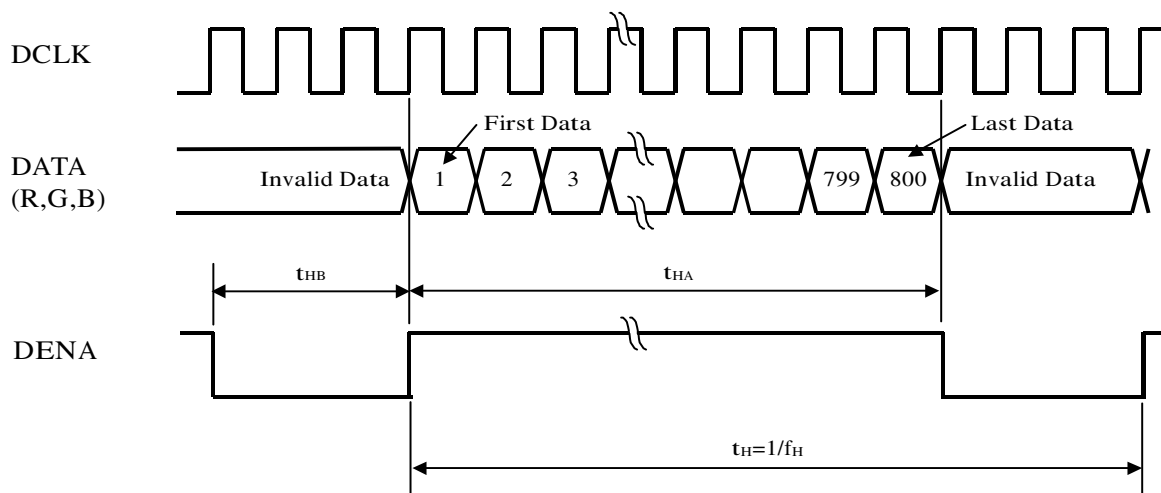

c. Vertical Timing Chart

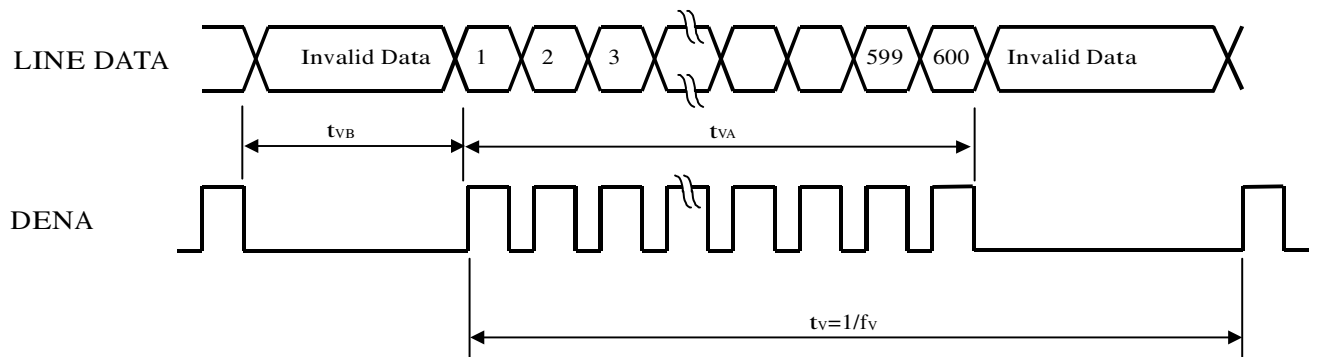

(3) Color Data Assignment

COLOR		INPUT DATA																	
		R DATA					G DATA					B DATA							
		R5	R4	R3	R2	R1	R0	G5	G4	G3	G2	G1	G0	B5	B4	B3	B2	B1	B0
		MSB					LSB	MSB					LSB	MSB					LSB
BASIC COLOR	BLACK	0	0	0	0	0	0	0	0	0	0	0	0	0	0	0	0	0	
	RED(63)	1	1	1	1	1	1	0	0	0	0	0	0	0	0	0	0	0	
	GREEN(63)	0	0	0	0	0	0	1	1	1	1	1	1	0	0	0	0	0	
	BLUE(63)	0	0	0	0	0	0	0	0	0	0	0	0	1	1	1	1	1	
	CYAN	0	0	0	0	0	0	1	1	1	1	1	1	1	1	1	1	1	
	MAGENTA	1	1	1	1	1	1	0	0	0	0	0	0	1	1	1	1	1	
	YELLOW	1	1	1	1	1	1	1	1	1	1	1	1	0	0	0	0	0	
	WHITE	1	1	1	1	1	1	1	1	1	1	1	1	1	1	1	1	1	
RED	RED(1)	0	0	0	0	0	1	0	0	0	0	0	0	0	0	0	0	0	
	RED(2)	0	0	0	0	1	0	0	0	0	0	0	0	0	0	0	0	0	
	RED(62)	1	1	1	1	1	0	0	0	0	0	0	0	0	0	0	0	0	
	RED(63)	1	1	1	1	1	1	0	0	0	0	0	0	0	0	0	0	0	
GREEN	GREEN(1)	0	0	0	0	0	0	0	0	0	0	0	1	0	0	0	0	0	
	GREEN(2)	0	0	0	0	0	0	0	0	0	0	1	0	0	0	0	0	0	
	GREEN(62)	0	0	0	0	0	0	1	1	1	1	1	0	0	0	0	0	0	
	GREEN(63)	0	0	0	0	0	0	1	1	1	1	1	1	0	0	0	0	0	
BLUE	BLUE(1)	0	0	0	0	0	0	0	0	0	0	0	0	0	0	0	0	1	
	BLUE(2)	0	0	0	0	0	0	0	0	0	0	0	0	0	0	0	0	1	
	BLUE(62)	0	0	0	0	0	0	0	0	0	0	0	0	1	1	1	1	0	
	BLUE(63)	0	0	0	0	0	0	0	0	0	0	0	0	1	1	1	1	1	

[Note]

1) Definition of gray scale

Color (n) ---n indicates gray scale level.

Higher n means brighter level.

2) Data

1:High, 0: Low

(4) Display Position and Scan Direction

D(X,Y) shows the data number of input signal for LCD panel signal processing PCB.

SC:Low

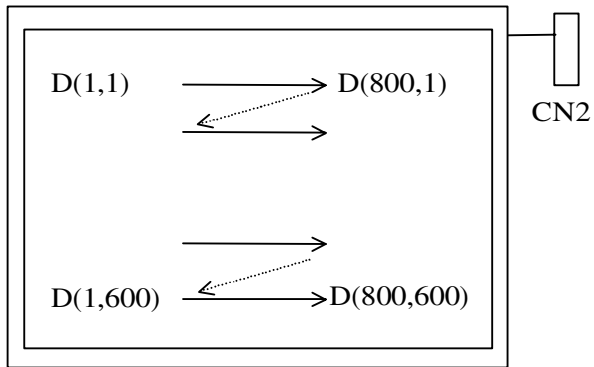

SC:High

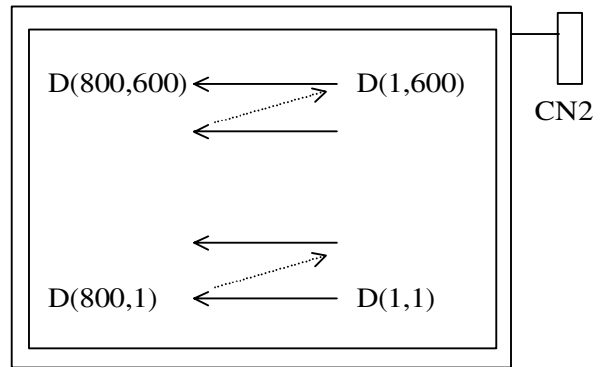

7. BLOCK DIAGRAM

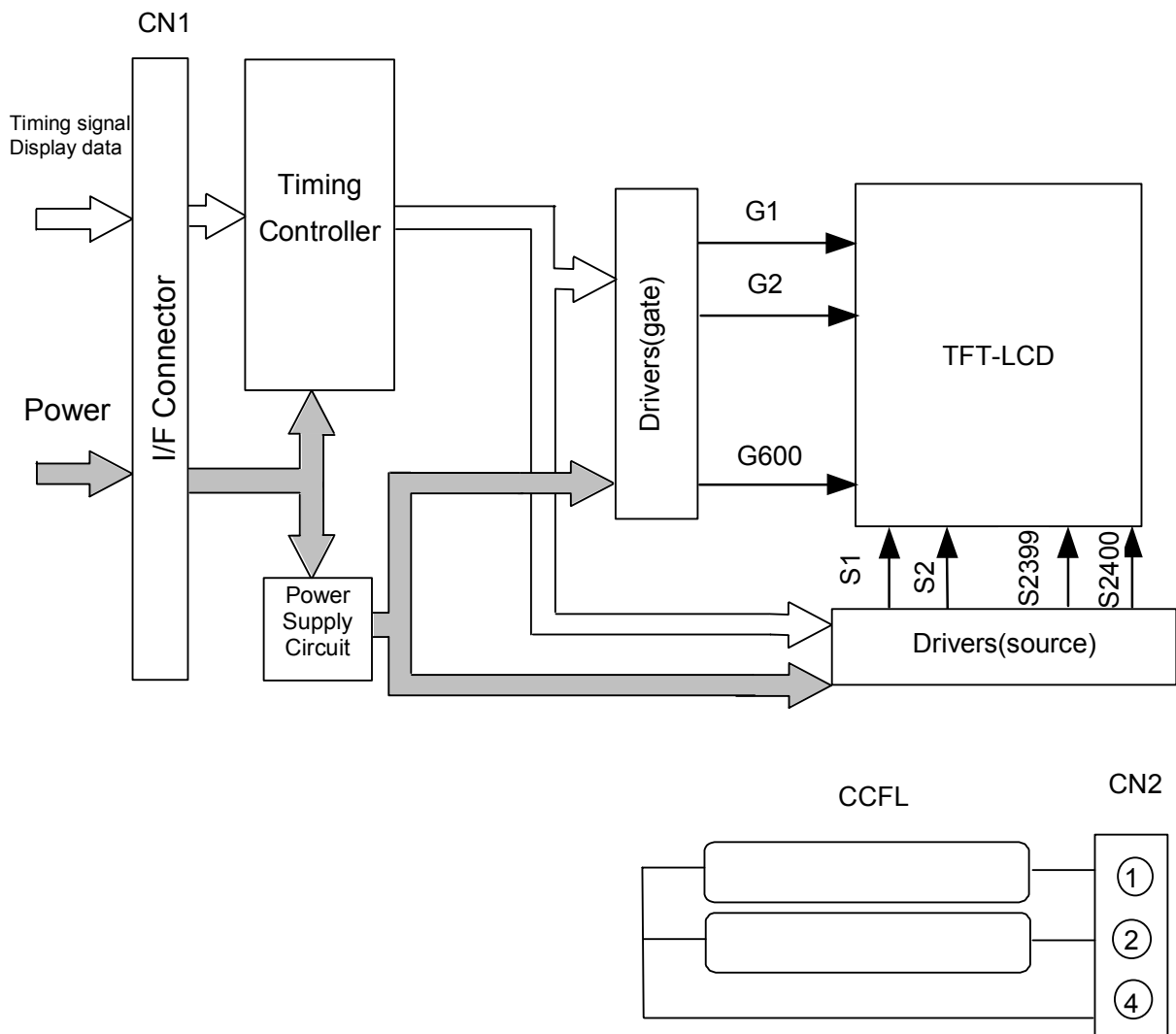

8. MECHANICAL SPECIFICATIONS

(1) Front Side

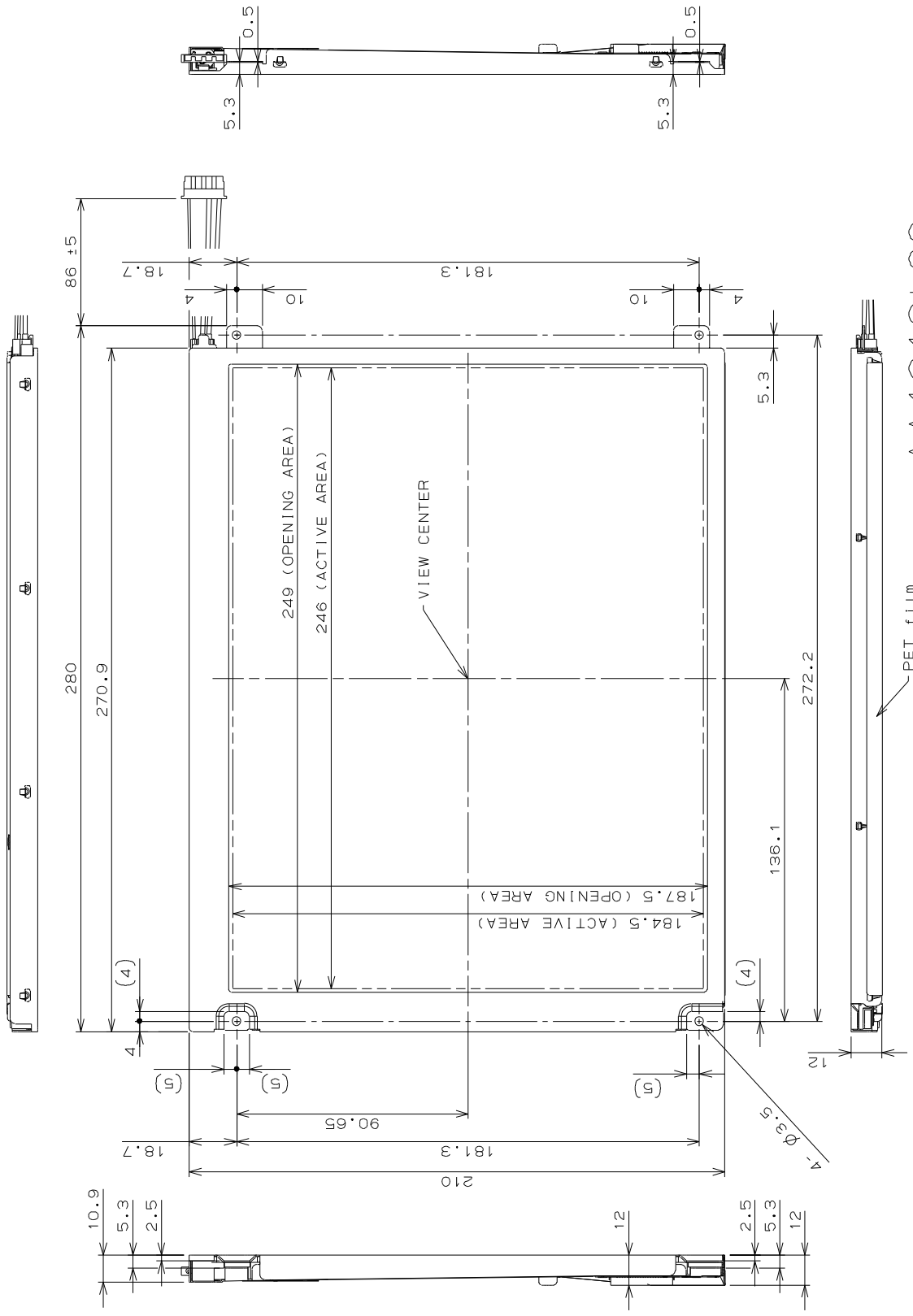

AA121SL09

- 1) Tolerance is ±0.5mm unless noted.
- 2) Thickness of PET film is not included.
- 3) Third angle projection

(Unit: mm)

(2) Rear Side

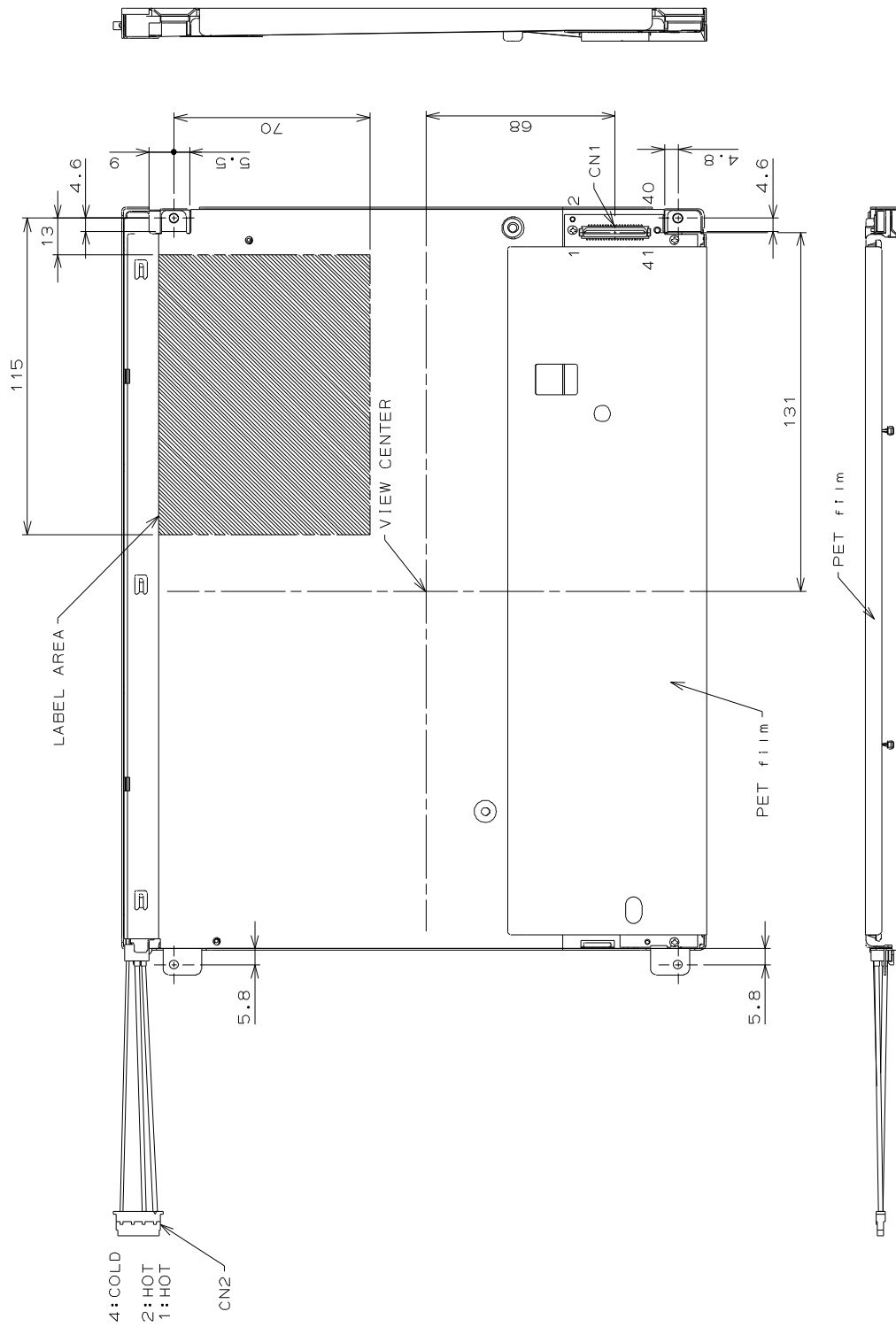

AA121SL09

- 1) Tolerance is ± 0.5 mm unless noted.
- 2) Thickness of PET film is not included.
- 3) Third angle projection

CN1: DF9B-41P-1V(32) (HIROSE)
CN2: BHR-04VS-1 (JST)

(Unit:mm)

9. OPTICAL CHARACTERISTICS

Ta=25°C, VCC=3.3V, Input Signals: Typ. Values shown in Section 6

ITEM	SYMBOL	CONDITION	MIN	TYP	MAX	UNIT	Remarks	
Contrast Ratio	CR	$\theta_v=0^\circ, \theta_H=0^\circ$	350	500	--	--	*1)*2)*5)	
Luminance	Lw	$\theta_v=0^\circ, \theta_H=0^\circ$	250	400	--	cd/m ²	*1)*5)	
Luminance Uniformity	ΔLw	$\theta_v=0^\circ, \theta_H=0^\circ$	--	--	30	%	*1)*3)*5)	
Response Time	tr	$\theta_v=0^\circ, \theta_H=0^\circ$	--	6	--	ms	*1)*4)*5)	
	tf	$\theta_v=0^\circ, \theta_H=0^\circ$	--	19	--	ms	*1)*4)*5)	
Viewing Angle	Horizontal	θ_H	CR ≥ 10	-50~50	-65~65	--	°	*1)*5)
	Vertical	θ_v		-40~30	-75~45	--	°	*1)*5)
	Horizontal	θ_H	CR ≥ 5	-65~65	-80~80	--	°	*1)*5)
	Vertical	θ_v		-50~40	-80~55	--	°	*1)*5)
Image sticking	tis	2 h	--	--	2	s	*6)	
Color Coordinates	Red	Rx	$\theta_v=0^\circ, \theta_H=0^\circ$	0.545	0.575	0.605	--	*1)*5)
		Ry		0.297	0.327	0.357		
	Green	Gx		0.298	0.328	0.358		
		Gy		0.501	0.531	0.561		
	Blue	Bx		0.133	0.163	0.193		
		By		0.124	0.154	0.184		
	White	Wx		0.283	0.313	0.343		
		Wy		0.299	0.329	0.359		

[Note]

These items are measured using CS1000(MINOLTA) for color coordinates, EZContrast(ELDIM) for viewing angle and CS1000 or BM-5A(TOPCON) for others under the dark room condition (no ambient light) after more than 30 minutes from turning on the lamp unless noted.

Condition: IL = 12.0 mArms, FL=43 kHz

Measurement method for luminance and color coordinates is as follows.

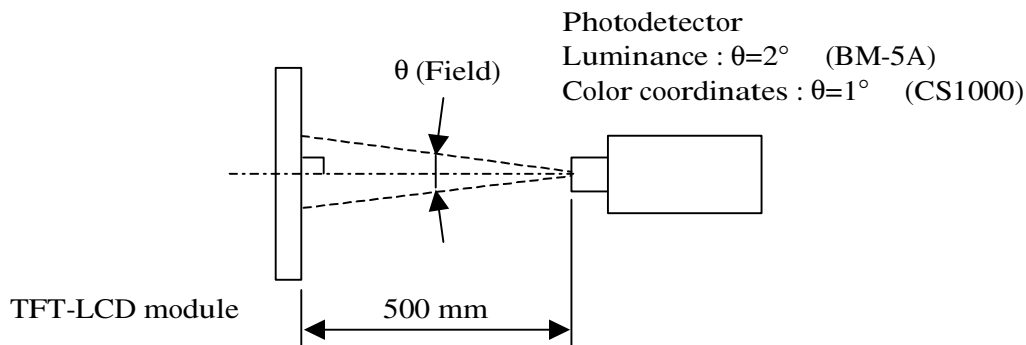

The luminance is measured according to FLAT PANEL DISPLAY MEASUREMENTS STANDARD (VESA Standard).

*1) Measurement Point

Contrast Ratio, Luminance, Response Time, Viewing Angle, Color Coordinates: Display Center
 Luminance Uniformity: point 1~5 shown in a figure below

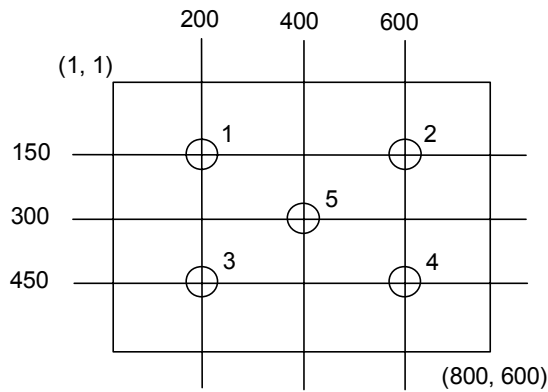

*2) Definition of Contrast Ratio

CR= Luminance with all white pixels / Luminance with all black pixels

*3) Definition of Luminance Uniformity

$\Delta Lw = [Lw(\text{MAX})/Lw(\text{MIN}) - 1] \times 100$

*4) Definition of Response Time

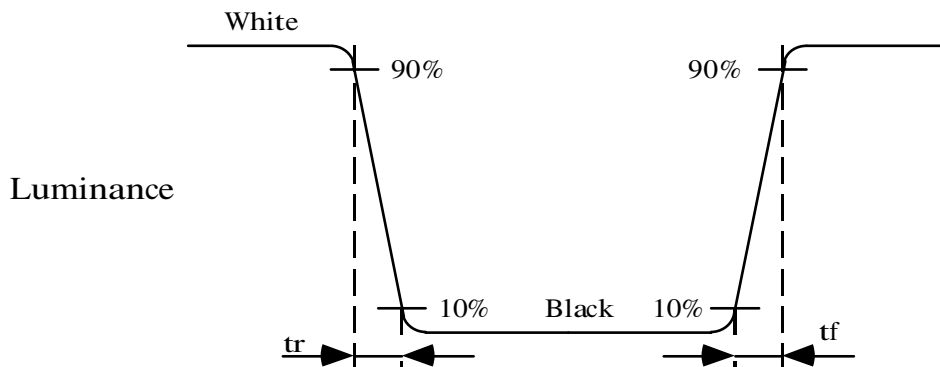

*5) Definition of Viewing Angle(θ_v , θ_H)

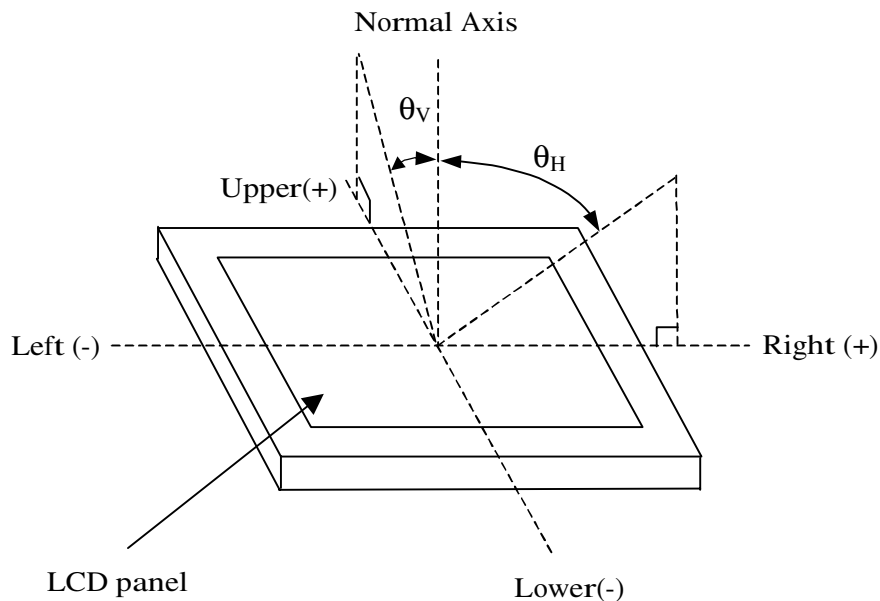

*6) Image sticking:

Continuously display the test pattern shown in the figure below for two-hours. Then display a completely white screen. The previous image shall not persist more than two seconds at 25°C.

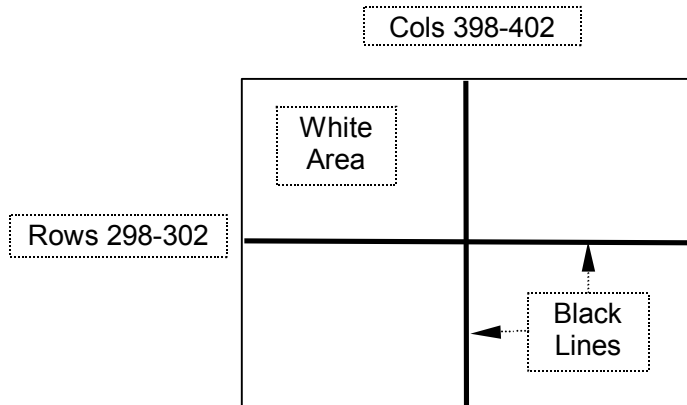

TEST PATTERN FOR IMAGE STICKING TEST

10. RELIABILITY TEST CONDITION

(1) Temperature and Humidity

ITEM	CONDITIONS
HIGH TEMPERATURE HIGH HUMIDITY OPERATION	40°C, 90%RH, 240 h (No condensation)
HIGH TEMPERATURE OPERATION	70°C, 240 h
LOW TEMPERATURE OPERATION	-20°C, 240 h
HIGH TEMPERATURE STORAGE	80°C, 240 h
LOW TEMPERATURE STORAGE	-20°C, 240 h
THERMAL SHOCK	BETWEEN -20°C (1h) and 80°C(1h), 100 CYCLES

(2) Shock & Vibration

ITEM	CONDITIONS
SHOCK (NON-OPERATION)	Shock level: 1470m/s ² (150G) Waveform: half sinusoidal wave, 2ms Number of shocks: one shock input in each direction of three mutually perpendicular axes for a total of six shock inputs
VIBRATION (NON-OPERATION)	Vibration level: 9.8m/s ² (1.0G) Waveform: sinusoidal Frequency range: 5 to 500Hz Frequency sweep rate: 0.5 octave /min Duration: one sweep from 5 to 500 Hz in each of three mutually perpendicular axis(each x,y,z axis: 1 hour, total 3 hours)

(3) Judgment standard

The judgment of the above tests should be made as follow:

Pass: Normal display image, no damage of the display function. (ex. no line defect)

Partial transformation of the module parts should be ignored.

Fail: No display image, damage of the display function. (ex. line defect)

11. OTHER FEATURE

This LCD module complies with RoHS*) directive.

*) RoHS: Restriction of the use of certain hazardous substances in electrical and electronic equipment

12. HANDLING PRECAUTIONS FOR TFT-LCD MODULE

Please pay attention to the followings in handling TFT-LCD products;

(1) ASSEMBLY PRECAUTION

- a. Please mount the LCD module by using mounting hole with a screw clamping torque (recommended value: 0.3 Nm). Please do not bend or wrench the LCD module in assembling. Please do not drop, bend or twist the LCD module in handling.
- b. Please design display housing in accordance with the following guide lines.
 - (a) Housing case must be designed carefully so as not to put stresses on LCD all sides and not to wrench module. The stresses may cause non-uniformity even if there is no non-uniformity statically.
 - (b) Keep sufficient clearance between LCD module back surface and housing when the LCD module is mounted. Approximately 1.0mm of the clearance in the design is recommended taking into account the tolerance of LCD module thickness and mounting structure height on the housing.
 - (c) When some parts, such as, FPC cable and ferrite plate, are installed underneath the LCD module, still sufficient clearance is required, such as 0.5mm. This clearance is, especially, to be reconsidered when the additional parts are implemented for EMI countermeasure.
 - (d) Design the inverter location and connector position carefully so as not to give stress to lamp cable, or not to interface the LCD module by the lamp cable.
 - (e) Keep sufficient clearance between LCD module and the others parts, such as inverter and speaker so as not to interface the LCD module. Approximately 1.0mm of the clearance in the design is recommended.
 - (f) To avoid local elevation/decrease of temperature, considering location of heating element, heat release, thermal design should be done.
- c. Please do not push or scratch LCD panel surface with anything hard. And do not soil LCD panel surface by touching with bare hands. (Polarizer film, surface of LCD panel is easy to be flawed.)
- d. Please do not press any parts on the rear side such as source TCP, gate TCP, control circuit board and FPCs during handling LCD module. If pressing rear part is unavoidable, handle the LCD module with care not to damage them.
- e. Please wipe off LCD panel surface with absorbent cotton or soft cloth in case of it being soiled.
- f. Please wipe off drops of adhesives like saliva and water on LCD panel surface immediately. They might damage to cause panel surface variation and color change.
- g. Please do not take a LCD module to pieces and reconstruct it. Resolving and reconstructing modules may cause them not to work well.
- h. Please do not touch metal frames with bare hands and soiled gloves. A color change of the

metal frames can happen during a long preservation of soiled LCD modules.

- i. Please handle metal frame carefully because edge of metal frame is very sharp.
- j. Please pay attention to handling lead wire of backlight so that it is not tugged in connecting with inverter.
- k. Please connect the metal frame of LCD module to GND in order to minimize the effect of external noise and EMI.
- l. Be sure to connect the cables and the connectors correctly.

(2) OPERATING PRECAUTIONS

- a. Please be sure to turn off the power supply before connecting and disconnecting signal input cable.
- b. Please do not change variable resistance settings in LCD module. They are adjusted to the most suitable value. If they are changed, it might happen LCD does not satisfy the characteristics specification.
- c. LCD backlight takes longer time to become stable of radiation characteristics in low temperature than in room temperature.
- d. The interface signal speed is very high. Please pay attention to transmission line design and other high speed signal precautions to satisfy signal specification.
- e. A condensation might happen on the surface and inside of LCD module in case of sudden change of ambient temperature.
- f. Please pay attention not to display the same pattern for very long time. Image might stick on LCD. Even if image sticking happens, it may disappear as the operation time proceeds.
- g. Please obey the same safe instructions as ones being prepared for ordinary electronic products.

(3) PRECAUTIONS WITH ELECTROSTATICS

- a. This LCD module use CMOS-IC on circuit board and TFT-LCD panel, and so it is easy to be affected by electrostatics. Please be careful with electrostatics by the way of your body connecting to the ground and so on.
- b. Please remove protection film very slowly from the surface of LCD module to prevent from electrostatics occurrence.

(4) STORAGE PRECAUTIONS

- a. Please do not leave the LCDs in the environment of high humidity and high temperature such as 60°C90%RH.
- b. Please do not leave the LCDs in the environment of low temperature; below -20°C.

(5) SAFETY PRECAUTIONS

- a. When you waste damaged or unnecessary LCDs, it is recommended to crush LCDs into pieces and wash them off with solvents such as acetone and ethanol, which should later be burned.
- b. If any liquid leaks out of a damaged glass cell and comes in contact with the hands, wash off thoroughly with soap and water.
- c. Be sure to turn off the power supply when inserting or disconnecting the cable.
- d. Inverter should be designed carefully so as not to keep working in case of detecting over current or open circuit on the lamp.

(6) OTHERS

- a. A strong incident light into LCD panel may cause deterioration to polarizer film, color filter, and other materials, which will degrade the quality of display characteristics. Please do not expose LCD module under strong Ultraviolet rays for a long time.
- b. Please pay attention to a panel side of LCD module not to contact with other materials in preserving it alone.
- c. For the packaging box, please pay attention to the followings;
 - (a) Packaging box and inner case for LCD are designed to protect the LCDs from the damage or scratching during transportation. Please do not open except picking LCDs up from the box.
 - (b) Please do not pile them up more than 5 boxes. (They are not designed so.) And please do not turn over.
 - (c) Please handle packaging box with care not to give them sudden shock and vibrations. And also please do not throw them up.
 - (d) Packaging box and inner case for LCDs are made of cardboard. So please pay attention not to get them wet. (Such like keeping them in high humidity or wet place can occur getting them wet.)