

# Product Information

**ISSUE DATA : 2006-11-08**

**MODEL : LMS700KF01-001**

**Note : The Product and specifications are subject to change without any notice.  
Please ask for the latest Product Standards to guarantee the satisfaction of  
your product requirements.**

**PREPARED BY : AM LCD Mobile Display Development**

**Samsung Electronics Co. , LTD.**

## **Contents**

Revision History	----- (3)
General Description	----- (4)
1. Absolute Maximum Ratings	----- (6)
1.1 Absolute Ratings Of Environment	
1.2 Electrical Absolute Ratings	
2. Optical Characteristics	----- (8)
3. Electrical Characteristics	----- (12)
3.1 TFT-LCD Module	
3.2 Back-light Unit	
4. Touch Screen Panel Specification	----- (14)
4.1 Electrical Characteristics	
4.2 Mechanical & Reliability Characteristics	
4.3 Design Guide	
5. Block Diagram	----- (16)
5.1 TFT-LCD Module with Back Light Unit	
5.2. Back Light Unit	
5.3. Touch Panel Unit	
6. Input Terminal Pin Assignment	----- (19)
6.1 Input Signal & Power	
6.2 Input Signal, Basic Display Colors and Gray Scale of Each Colors	
6.3 Pixel Format	
7. Interface Timing	----- (22)
7.1 Vertical Timing	
7.2 Horizontal Timing	
7.3 24 bit RGB Interface Timing	
7.4 AC Characteristic	
8. Power Up/Down Sequence	----- (25)
8.1 Power up sequence	
8.2 Power up sequence	
9. Outline Dimension	----- (27)
10. Packing	----- (28)
11. Marking & Others	----- (29)
12. General Precaution	----- (30)
12.1 Handling	
12.2 Storage	
12.3 Operation	
12.4 Others	

# Revision History

Preliminary

Data	Rev. No.	Page	Summary
Nov. 08. 2006	000		Rev.000 is first issued.

## General Description

### \* Description

LMS700KF01 is a TMR(Transmissive with Micro Reflective) type color active matrix TFT (Thin Film Transistor) liquid crystal display (LCD) that uses amorphous silicon TFT as a switching devices. This model is composed of a TFT-LCD module, a driver circuit and a back-light unit. The resolution of a 7.0" contains 800 x 480(RGB) dots and can display up to 16.7M colors.

### \* Features

- Triple-Gate Technology applied
- Transmissive with Micro Reflective type and Back-light with LED is available.
- TN (Twisted Nematic) mode
- 24bit RGB Interface
- Back Light with 24 LEDs (Light Emitting Diode)

### \* Applications

- Display terminals for PMP(Portable Multimedia Player) , Portable CNS(P-CNS) , AV , UMPC (Ultra Mobile PC) application products.

**\* General information**

Items	Specification	Unit	Note
Display area	152.4(H) x 91.44(V)	mm	-
Driver element	a-Si TFT active matrix	-	-
Display colors	16.7M	colors	-
Number of pixels	800(H) x 480 x RGB(V)	dot	-
Pixel arrangement	RGB stripe type (Horizontal)	-	-
Pixel pitch	0.1905(H) x 0.1905(V)	mm	-
Display mode	Normally white	-	-
Viewing direction	6	o'clock	Note 1

Note 1. Gray inversion at the viewing direction

**\* Mechanical information**

Item		Min.	Typ.	Max.	Unit	Note
Module size	Horizontal(H)	162.9	163.2	163.5	mm	-
	Vertical(V)	103.7	104.0	104.3	mm	Note 2
	Depth(D)	4.3	4.5	4.7	mm	Note 2
Weight		-	(115)	-	g	-

Note 2. Not include FPC

Refer to the Outline Dimension in the "9.Outline Dimension" for further information.

# 1. Absolute Maximum Ratings

## 1.1 Absolute Ratings of Environment

Item	Symbol	Min.	Max.	Unit	Note
Storage temperature	T <sub>STG</sub>	-30	70	°C	(1)
Operating temperature (Ambient temperature)	T <sub>OPR</sub>	-20	60	°C	(1),(2)

Note (1) 95 % RH Max. ( 40 °C <sup>3</sup> Ta )

Maximum wet-bulb temperature at 39 °C or less. (Ta > 40 °C) No condensation.

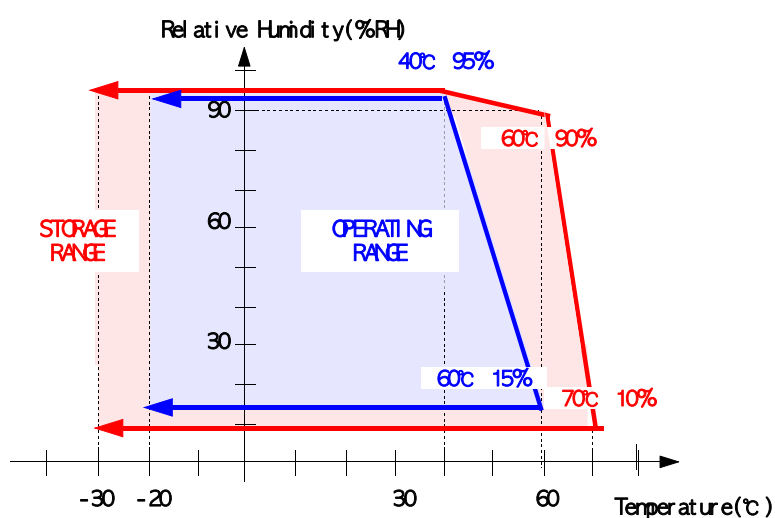

- (2) In case of below 0°, the response time of liquid crystal (LC) becomes slower and the color of panel becomes darker than normal one.  
Level of retardation depends on temperature, because of LC's characteristics.
- (3) If any fixed pattern is displayed on LCD for minutes, image-sticking phenomenon may occur.
- (4) Degradation could occur to pixels' TFT when DC BIOS is input into its gate-signal under POWER OFF WAITING STAND-BY & SLEEP MODE.  
Therefore, LCD should be turn off then.

## 1.2 Electrical Absolute Ratings

### (1) TFT-LCD Module

(Ta = 25°C, V<sub>SS</sub>=GND=0V)

Characteristics	Symbol	Min.	Max.	Unit	Note
Power supply voltage	V <sub>CC</sub>	-0.5	5.0	V	-

### (2) Back-Light Unit

(Ta = 25 ± 2°C)

Item	Symbol	Min.	Max.	Unit.	Note
LED Current	I <sub>L</sub>	-	30	mA	(1)

Note (1) Permanent damage to the device may occur if maximum values are exceeded or reverse voltage is loaded.

Functional operation should be restricted to the conditions described under normal operating conditions.

## 2. Optical Characteristics (TBD)

The following items are measured under stable conditions. The optical characteristics should be measured in a dark room or equivalent state with the methods shown in Note (1).

Measuring equipment: SR-3, BM-7, EZ-Contrast

(Ta = 25 ± 2°C, Vcc = 3.3V, f<sub>B</sub> = 60Hz, I<sub>B</sub> = 20mA)

Item	Symbol	Condition	Min.	Typ.	Max.	Unit	Note	
Contrast ratio (Center point)	C/R	NOTE (1)	-	300	-	-	(2) SR-3	
Luminance of white (Center point)	YL		220	280	-	cd/m <sup>2</sup>	(3) SR-3	
Response time	Rising:Tr Falling:Tf		Tr+Tf	f = 0 q = 0	-	22.7	-	msec (4) BM-7
Color chromaticity (CIE 1931)	White	Wx	Normal Viewing Angle  B/L On	-	0.326	-	-	(5) SR-3
		Wy		-	0.354	-		
	Red	Rx		-	0.618	-		
		Ry		-	0.364	-		
	Green	Gx		-	0.347	-		
		Gy		-	0.563	-		
Blue	Bx	-	0.145	-				
	By	-	0.123	-				
Viewing angle	Hor.	qL	C/R <sup>3</sup> 10	-	65	-	Degrees	(6) Ez-Contrast
		qR		-	65	-		
	Ver.	fH	B/L On	-	50	-		
		fL		-	60	-		



Note (1) Test Equipment Setup

After stabilizing and leaving the panel alone at a given temperature for 30 min , the measurement should be executed. Measurement should be executed in a stable, windless, and dark room. 30 min after lighting the back-light. This should be measured in the center of screen.

Environment condition :  $T_a = 25 \pm 2 \text{ }^\circ\text{C}$

Back-Light On condition

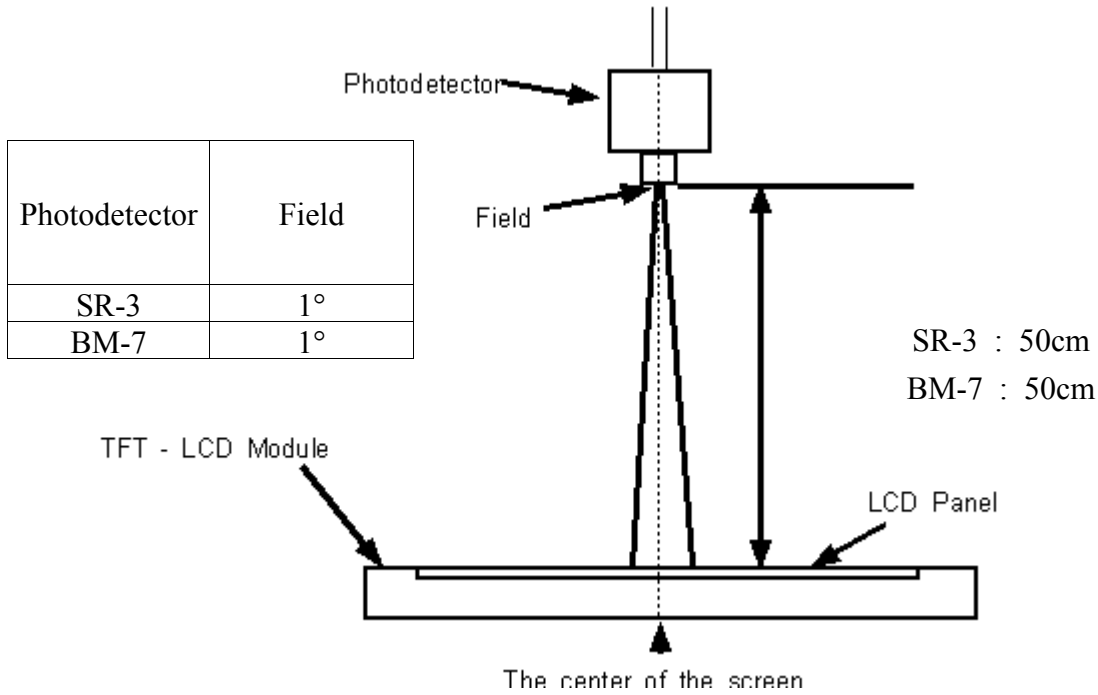

Note (2) Definition of Contrast Ratio (C/R) : Ratio of gray max (Gmax) & gray min (Gmin) at the center point

$$CR = \frac{G_{max}}{G_{min}}$$

\* Gmax : Luminance with all pixels white

\* Gmin : Luminance with all pixels black

Note (3) Definition of Luminance of White : Luminance of white at the center point

Note (4) Definition of Response time : Sum of  $T_r$ ,  $T_f$

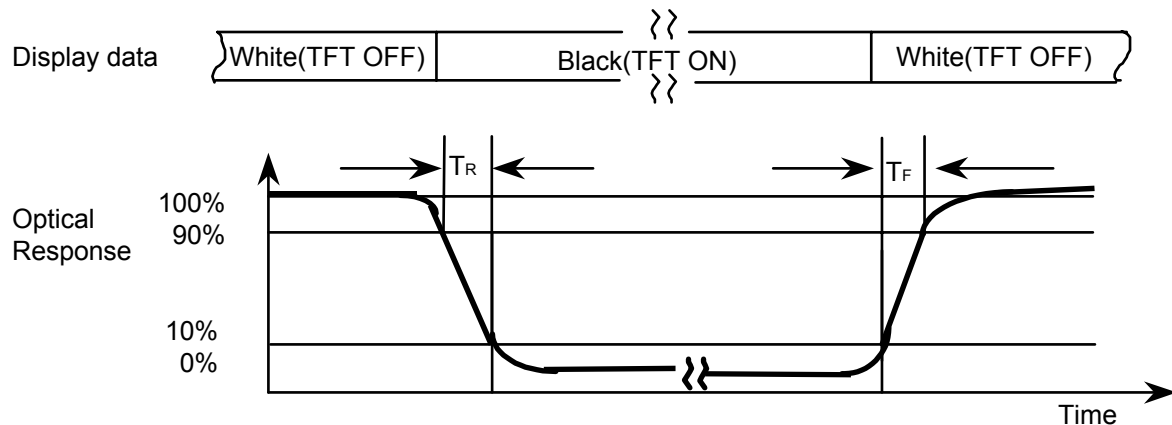

Note (5) Definition of Color Chromaticity (CIE 1931)

Color coordinate of white & red, green, blue at center point.

Note (6) Definition of Viewing Angle : Viewing angle range ( $CR \geq 10$  )

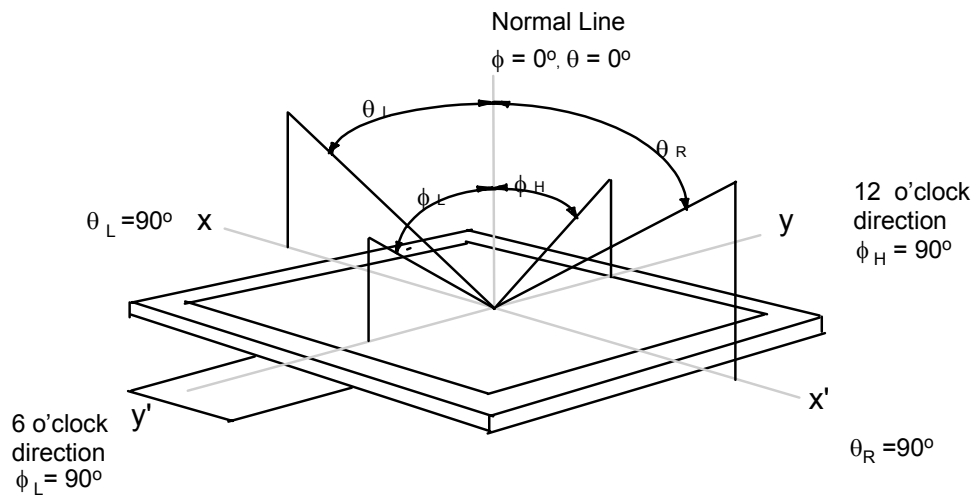

### 3. Electrical Characteristics

#### 3-1 TFT-LCD Module

Ta = 25 ± 2°C

Characteristics	Symbol	Min.	Typ.	Max.	Unit	Note
Power supply voltage	V <sub>CC</sub>	3.0	3.3	-	V	-
Power Dissipation	White	-	200	-	mW	(1),(2)
	Black	-	205	-		
	1 DOT	-	400	-		
Frame frequency	f <sub>Frame</sub>	-	60	-	Hz	-
Dot Clock	DOTCLK	-	24.5	-	MHz	-

\* To prevent a latch-up or DC operation of the LCD module, the power on/off sequence should be as the Chapter 7. Power Up/Down Sequence.

Note (1) V<sub>CC</sub> = 3.3V, f<sub>Frame</sub> = 60Hz, DOTCLK = 24.5MHz  
 (2) Dissipation current check pattern

▶ White pattern

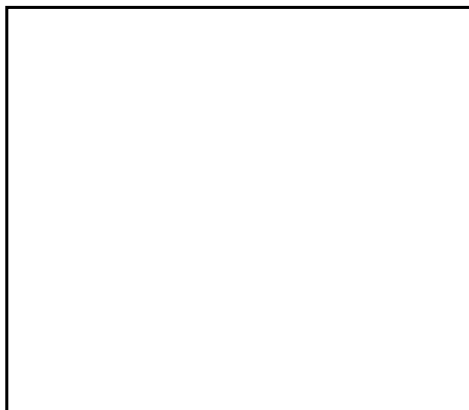

▶ Black pattern

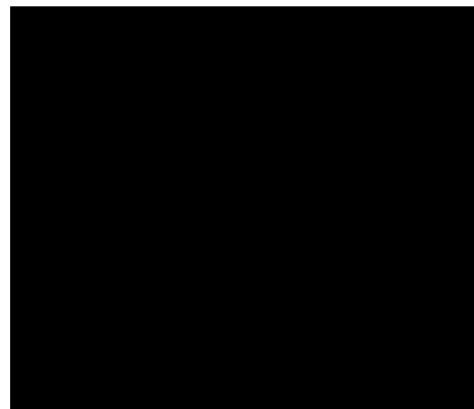

▶ 1 Dot pattern

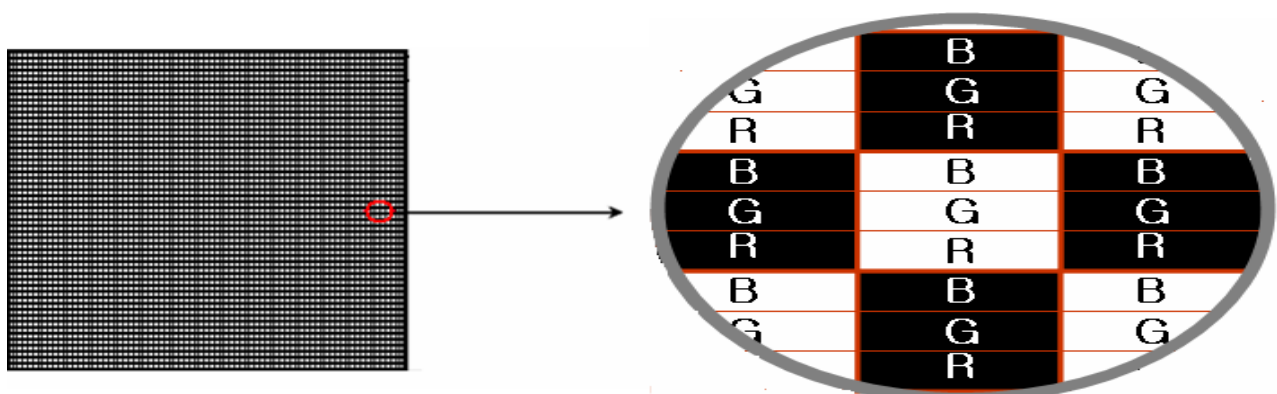

### 3-2 Back-Light unit

The Back Light system is an edge-lighting type with 24 white LED (Light Emitting Diode)s.

( $T_a=25 \pm 2^\circ\text{C}$ )

Item	Symbol	Min.	Typ.	Max.	Unit	Note
LEDs Current	$I_B$	15	20	25	mA	(1)
Power Consumption	$P_{BL}$	1.2	1.6	2.0	W	-

Note (1) The LEDs parallel type (Refer to 5.2)

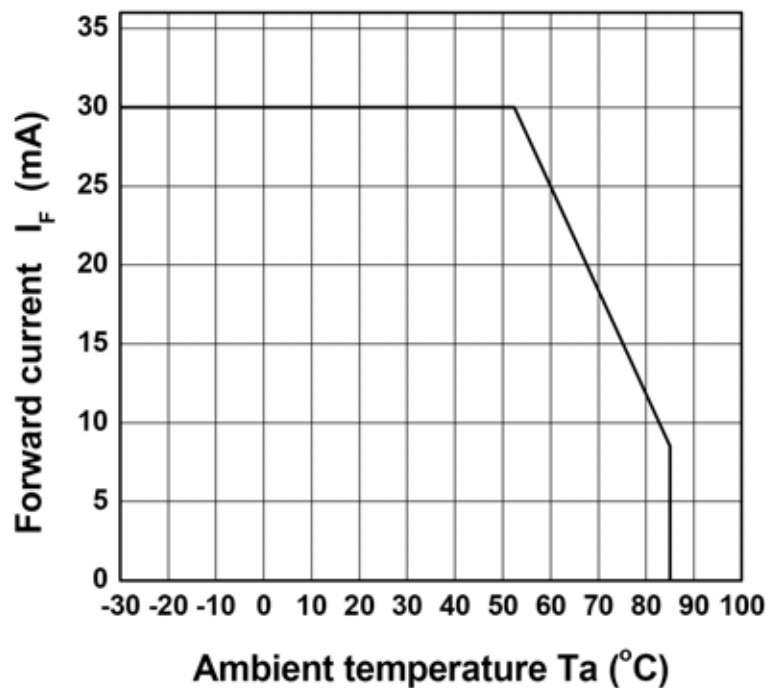

## 4. Touch Screen Panel Specifications (TBD)

### 4-1. Electrical Characteristics

Item	Min.	Typ.	Max.	Unit	Note
Linearity	-1.5	-	1.5	%	Analog X and Y directions
Terminal resistance	100	600	900	$\Omega$	X
	100	300	900	$\Omega$	Y
Insulation resistance	10	-	-	M $\Omega$	DC 25V
Voltage	3	5	7	V	DC
Chattering	-	-	10	ms	100k $\Omega$ pull-up
Transparency	78	80	-	%	JIS-K7105,ASTM D1003,@550nm

Caution (1) : Do not operate it with a thing except a polyacetal pen(tip R0.8mm or more) or a finger, especially those with hard or sharp tips such as a ball point pen or a mechanical pencil.

### 4-2. Mechanical & Reliability Characteristics

Item	Min.	Typ.	Max.	Unit	Note
Activation force	-	-	80	g	(1)
Durability (surface scratching)	Write 100,000	-	-	characters	(2)
Durability (surface pitting)	1,000,000	-	-	touches	(3)
Surface hardness	3	-	-	H	JIS-K5400, ASTM D3363

Note (1) Stylus pen Input : R0.8mm polyacetal pen or Finger

(2) Measurement for Surface area

- Scratch 100,000 times straight line on the Film with a stylus change every 20,000times
- Force : 250gf
- Speed : 60mm/sec
- Stylus : R0.8 polyacetal tip

(3) Pit 1,000,000 times on the Film with a R8.0 silicon rubber.

- Force : 250gf
- Speed : 2times/sec

### 4-3. Design Guide

- Avoid the design that Front-case overlap and press on the active area of the touch-panel.
- Give enough gap (over 0.5mm at compressed) between the front case and touch-panel to protect wrong operating.

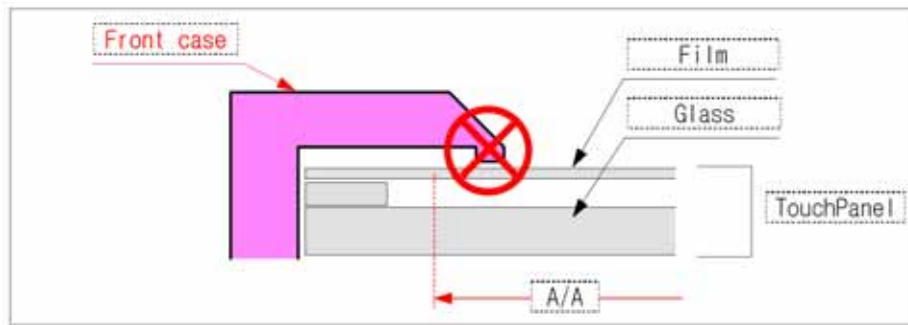

- Use a buffer material(Gasket) between the touch-panel and Front-case to protect damage and wrong operating.
- Avoid the design that buffer material overlap and press on the inside of touch-panel viewing area.

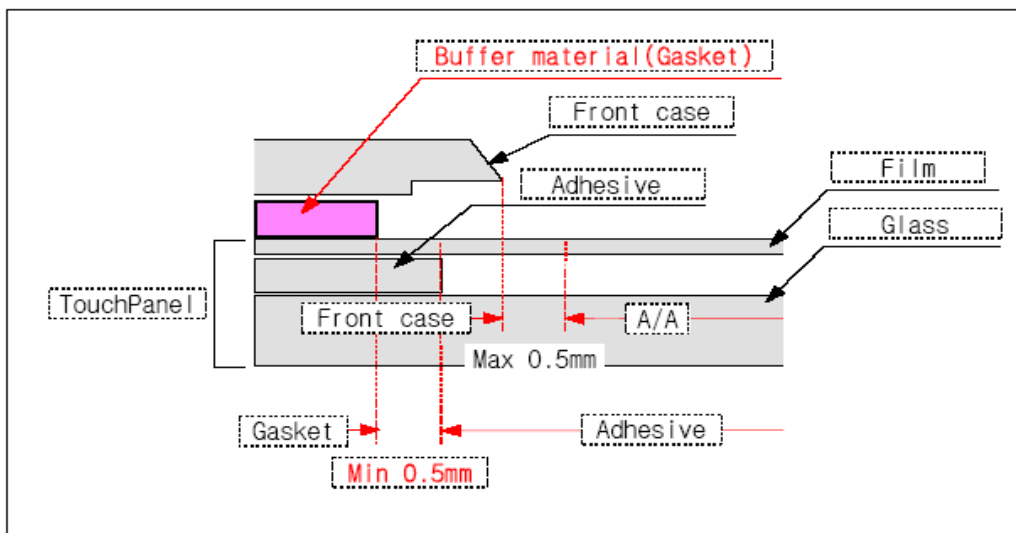

## 5. Block Diagram

### 5-1 TFT-LCD Module (Interface System Structure) with Back Light Unit

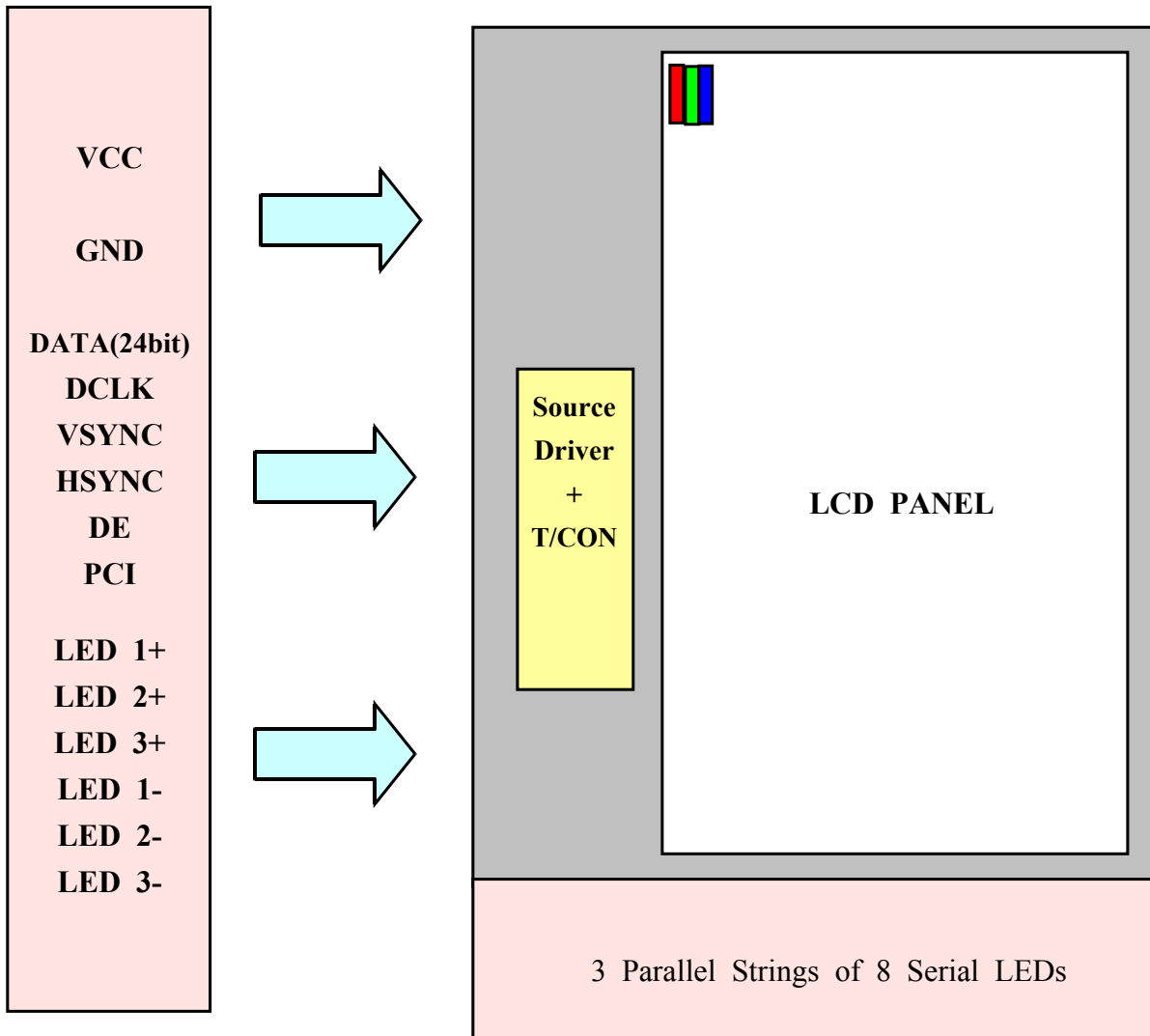



## 5-2 Back Light Unit

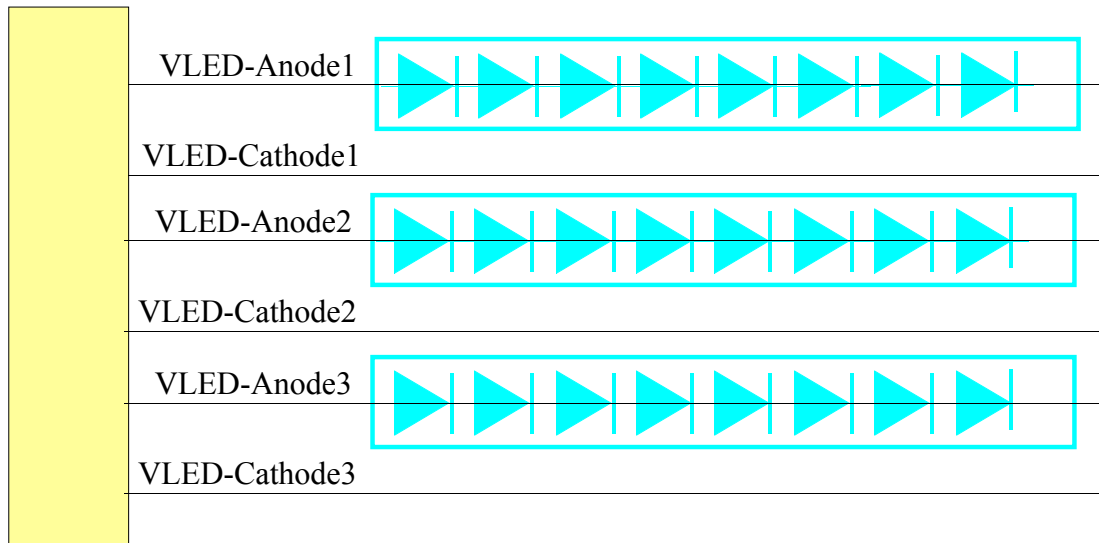

Pin No.	Pin Description
#1	VLED-Anode1
#2	VLED-Cathode1
#3	VLED-Anode2
#4	VLED-Cathode2
#5	VLED-Anode3
#6	VLED-Cathode3

\* Note) LED FPC Connector : 04-6298-006-000-883 (Kyocera) or compatible connector is preferred

5-3 Touch Panel Unit

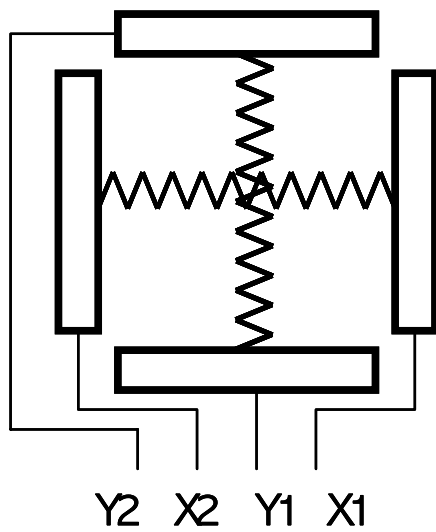

Top View

X : Upper electrode  
Y : Lower electrode

Pin No.	Symbol	Description
#1	Y2	TSP Top
#2	X2	TSP Left
#3	Y1	TSP Bottom
#4	X1	TSP Right

\* Note) TSP FPC Connector : FH19SC-4S-0.5SH (Hirose) or compatible connector is preferred

## 6. Input Terminal Pin Assignment

### 6-1 Input Signal & Power (Connector : 40Pin FPC Connector type, 0.5mm,

ex.) Hirose connector FH28H-40S-0.5SH or compatible Connector used.)

Pin No	Symbol	Description	I/O	Pin No	Symbol	Description	I/O
1	GND	GND	I	21	PD0	Graphic Data 0 (B0)	I
2	GND	GND	I	22	PD1	Graphic Data 1 (B1)	I
3	Vcc	System Power Supply	I	23	PD2	Graphic Data 2 (B2)	I
4	Vcc	System Power Supply	I	24	PD3	Graphic Data 3 (B3)	I
5	PD16	Graphic Data 16 (R0)	I	25	PD4	Graphic Data 4 (B4)	I
6	PD17	Graphic Data 17 (R1)	I	26	PD5	Graphic Data 5 (B5)	I
7	PD18	Graphic Data 18 (R2)	I	27	PD6	Graphic Data 6 (B6)	I
8	PD19	Graphic Data 19 (R3)	I	28	PD7	Graphic Data 7 (B7)	I
9	PD20	Graphic Data 20 (R4)	I	29	GND	GND	I
10	PD21	Graphic Data 21 (R5)	I	30	DOTCLK	DOT CLOCK	I
11	PD22	Graphic Data 22 (R6)	I	31	PCI	Display Mode <span style="color: red;">*Note</span>	I
12	PD23	Graphic Data 23 (R7)	I	32	HSYNC	HSYNC	I
13	PD8	Graphic Data 8 (G0)	I	33	VSYNC	VSYNC	I
14	PD9	Graphic Data 9 (G1)	I	34	DE	Data Enabling Signal	I
15	PD10	Graphic Data 10 (G2)	I	35	NC	No Connect	-
16	PD11	Graphic Data 11 (G3)	I	36	NC	No Connect	-
17	PD12	Graphic Data 12 (G4)	I	37	GND	GND	I
18	PD13	Graphic Data 13 (G5)	I	38	GND	GND	I
19	PD14	Graphic Data 14 (G6)	I	39	NC	No Connect	-
20	PD15	Graphic Data 15 (G7)	I	40	NC	No Connect	-

\* Note : Regarding to the PCI, Please refer to the Power up/down sequence

### 6-2 Input Signal, Basic Display Colors and Gray Scale of Each Colors

COLOR	DISPLAY	DATA SIGNAL																					GRAY SCALE LEVEL			
		RED							GREEN							BLUE										
		R0	R1	R2	R3	R4	R5	R6	R7	G0	G1	G2	G3	G4	G5	G6	G7	B0	B1	B2	B3	B4		B5	B6	B7
BASIC COLOR	BLACK	0	0	0	0	0	0	0	0	0	0	0	0	0	0	0	0	0	0	0	0	0	0	0	0	-
	BLUE	0	0	0	0	0	0	0	0	0	0	0	0	0	0	0	0	1	1	1	1	1	1	1	1	-
	GREEN	0	0	0	0	0	0	0	0	1	1	1	1	1	1	1	1	0	0	0	0	0	0	0	0	-
	CYAN	0	0	0	0	0	0	0	0	1	1	1	1	1	1	1	1	1	1	1	1	1	1	1	1	-
	RED	1	1	1	1	1	1	1	1	0	0	0	0	0	0	0	0	0	0	0	0	0	0	0	0	-
	MAGENTA	1	1	1	1	1	1	1	1	0	0	0	0	0	0	0	0	1	1	1	1	1	1	1	1	-
	YELLOW	1	1	1	1	1	1	1	1	1	1	1	1	1	1	1	1	0	0	0	0	0	0	0	0	-
	WHITE	1	1	1	1	1	1	1	1	1	1	1	1	1	1	1	1	1	1	1	1	1	1	1	1	-
GRAY SCALE OF RED	BLACK	0	0	0	0	0	0	0	0	0	0	0	0	0	0	0	0	0	0	0	0	0	0	0	R0	
	DARK ↑	1	0	0	0	0	0	0	0	0	0	0	0	0	0	0	0	0	0	0	0	0	0	0	R1	
		0	1	0	0	0	0	0	0	0	0	0	0	0	0	0	0	0	0	0	0	0	0	0	R2	
		:	:	:	:	:	:	:	:	:	:	:	:	:	:	:	:	:	:	:	:	:	:	:	:	R3~R252
		:	:	:	:	:	:	:	:	:	:	:	:	:	:	:	:	:	:	:	:	:	:	:	:	
	LIGHT ↓	1	0	1	1	1	1	1	1	0	0	0	0	0	0	0	0	0	0	0	0	0	0	0	R253	
		0	1	1	1	1	1	1	1	0	0	0	0	0	0	0	0	0	0	0	0	0	0	0	R254	
	RED	1	1	1	1	1	1	1	1	0	0	0	0	0	0	0	0	0	0	0	0	0	0	0	R255	
GRAY SCALE OF GREEN	BLACK	0	0	0	0	0	0	0	0	0	0	0	0	0	0	0	0	0	0	0	0	0	0	0	G0	
	DARK ↑	0	0	0	0	0	0	0	0	1	0	0	0	0	0	0	0	0	0	0	0	0	0	0	G1	
		0	0	0	0	0	0	0	0	0	1	0	0	0	0	0	0	0	0	0	0	0	0	0	G2	
		:	:	:	:	:	:	:	:	:	:	:	:	:	:	:	:	:	:	:	:	:	:	:	G3~G252	
		:	:	:	:	:	:	:	:	:	:	:	:	:	:	:	:	:	:	:	:	:	:	:		
	LIGHT ↓	0	0	0	0	0	0	0	0	1	0	1	1	1	1	1	1	0	0	0	0	0	0	0	G253	
		0	0	0	0	0	0	0	0	0	1	1	1	1	1	1	1	0	0	0	0	0	0	0	G254	
	GREEN	0	0	0	0	0	0	0	0	1	1	1	1	1	1	1	1	0	0	0	0	0	0	0	G255	
GRAY SCALE OF BLUE	BLACK	0	0	0	0	0	0	0	0	0	0	0	0	0	0	0	0	0	0	0	0	0	0	0	B0	
	DARK ↑	0	0	0	0	0	0	0	0	0	0	0	0	0	0	0	0	1	0	0	0	0	0	0	B1	
		0	0	0	0	0	0	0	0	0	0	0	0	0	0	0	0	1	0	0	0	0	0	0	B2	
		:	:	:	:	:	:	:	:	:	:	:	:	:	:	:	:	:	:	:	:	:	:	:	B3~B252	
		:	:	:	:	:	:	:	:	:	:	:	:	:	:	:	:	:	:	:	:	:	:	:		
	LIGHT ↓	0	0	0	0	0	0	0	0	0	0	0	0	0	0	0	0	1	0	1	1	1	1	1	B253	
		0	0	0	0	0	0	0	0	0	0	0	0	0	0	0	0	1	1	1	1	1	1	1	B254	
	BLUE	0	0	0	0	0	0	0	0	0	0	0	0	0	0	0	0	1	1	1	1	1	1	1	B255	

Note) Definition of Gray :

R<sub>n</sub> : Red Gray, G<sub>n</sub> : Green Gray, B<sub>n</sub> : Blue Gray (n = Gray level)

Input Signal : 0 = Low level voltage, 1 = High level voltage

### 6-3 Pixel Format

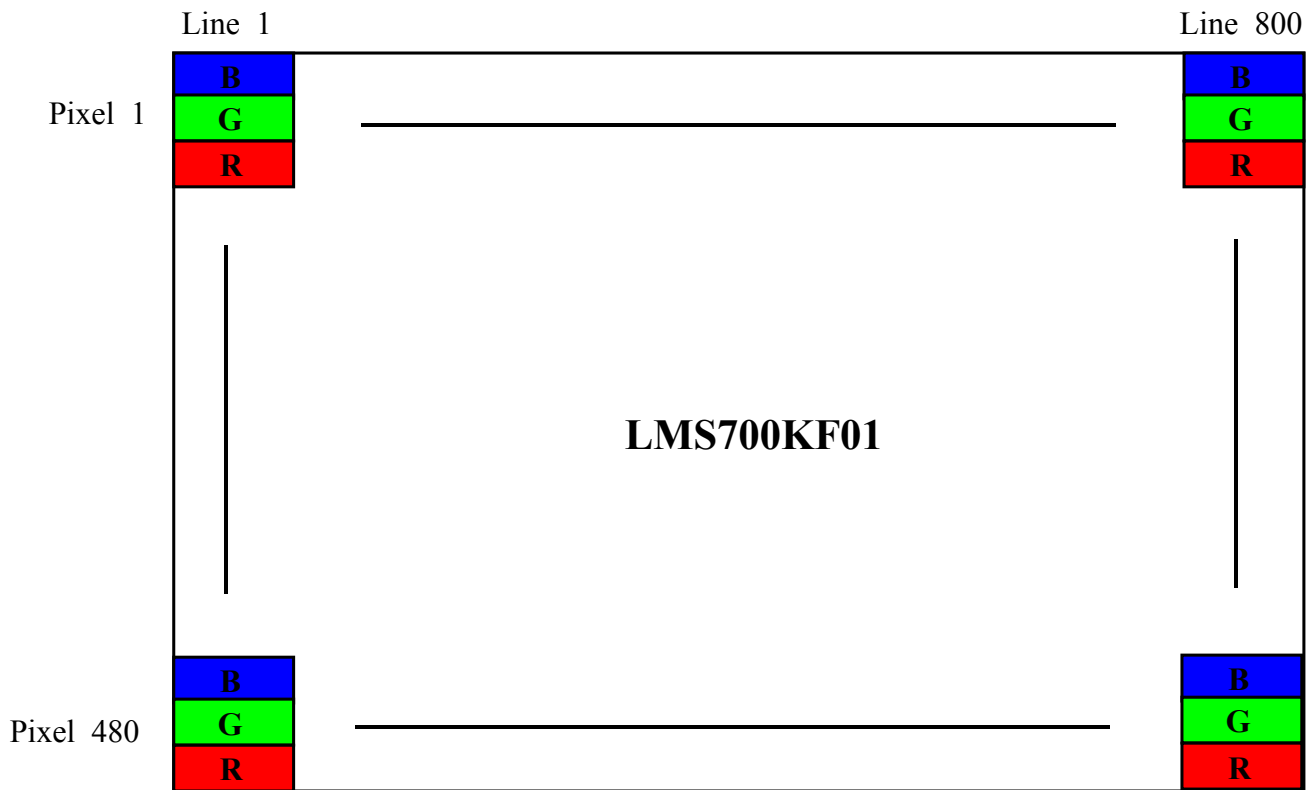

## 7. INTERFACE TIMING

### 7-1. Vertical timing

Signal	Symbol	Min.	Typ.	Max.	Unit	Note
Frame Frequency	f <sub>FRM</sub>	-	60	-	Hz	
Vertical Back porch	VBP	-	8	-	H	*Note
Vertical Front porch	VFP	-	5	-	H	*Note

### 7-2. Horizontal timing

Signal	Symbol	Min.	Typ.	Max.	Unit	Note
Horizontal Back porch	HBP	-	16	-	DOTCLK	*Note
Horizontal Front porch	HFP	-	8	-	DOTCLK	*Note
DOTCLK Frequency	f <sub>DOTCLK</sub>	-	24.5	-	MHz	@f <sub>FRM</sub> =60Hz

\*Note). VBP, VFP, HBP, HFP are fixed, set those timing data as the above data.

### 7-3 24bit RGB Interface Timing

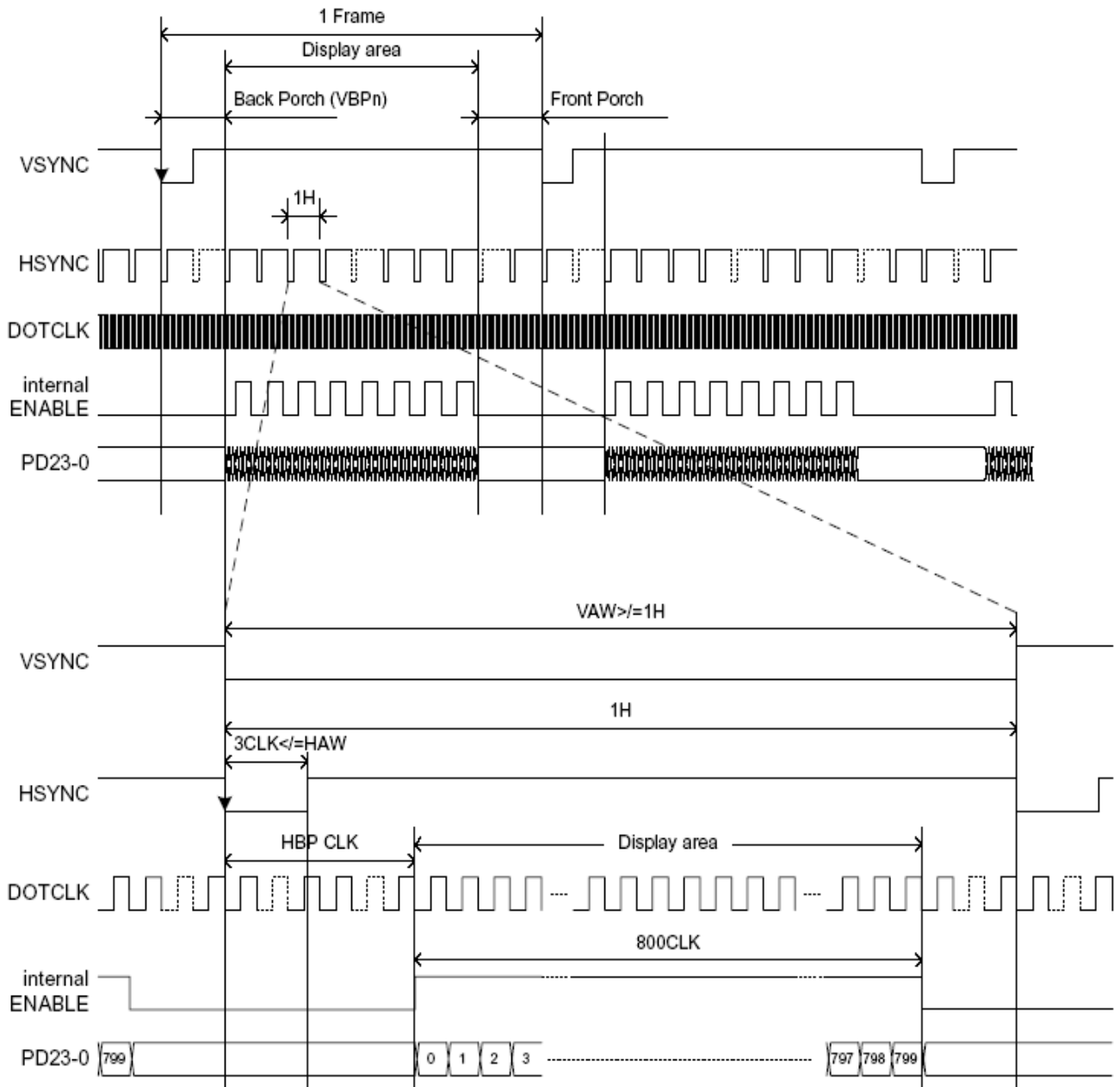

Note : Display Area : 480H  
 1 Frame = VBP+Display Area+VFP

7-4 AC Characteristic

(Ta=-40 to +85 °C, 24bit interface)

Parameter	Symbol	Min.	Typ.	Max.	Unit
VSYNC setup time	tVSS	5	-	-	ns
VSYNC hold time	tVSH	5	-	-	
HSYNC setup time	tHSS	5	-	-	
HSYNC hold time	tHSH	5	-	-	
DOTCLK cycle time	tDCYC	28	-	-	
DOTCLK rise/fall time	tR,tF		-	2	
DOTCLK Pulse width high	tDCHW	8	-	-	
DOTCLK Pulse width low	tDCLW	8	-	-	
DE setup time	tENS	5	-	-	
DE hold time	tENH	5	-	-	
PD data setup time	tPDS	5	-	-	
PD data hold time	tPDH	5	-	-	

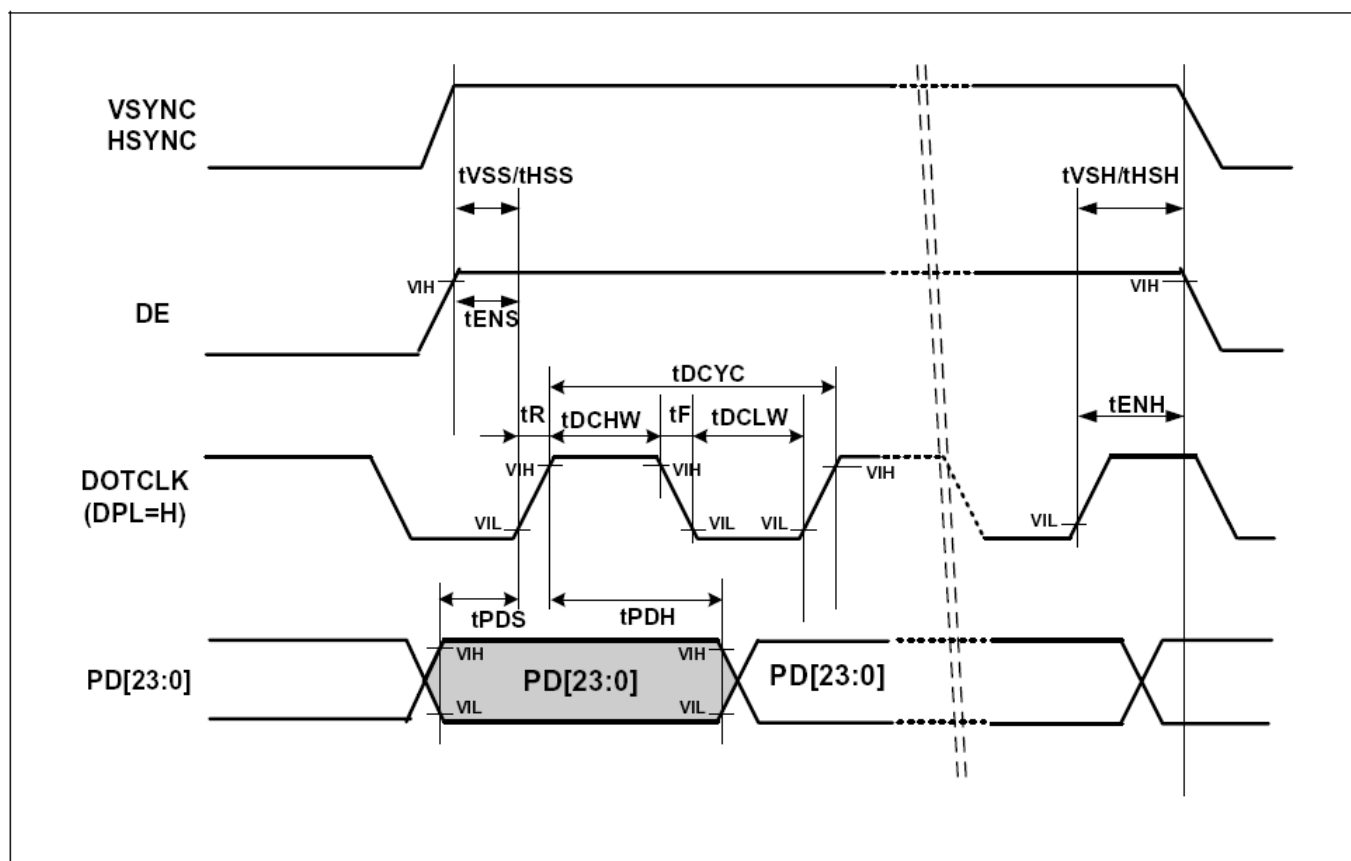



## 8. Power Up/Down sequence

### 8-1 Power up sequence.

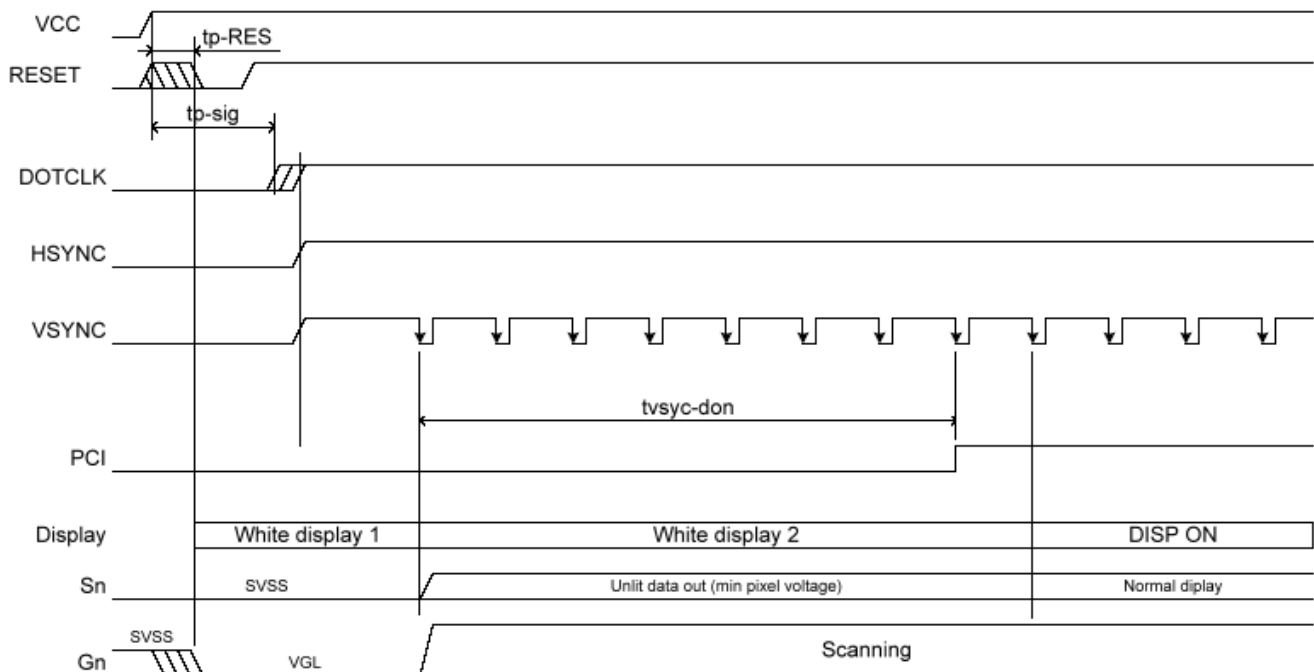

### Power up AC characteristics

Characteristics	Symbol	MIN	TYP	MAX	Unit
VCC on to signal input	tp-sig	5			mS
VCC on to RESET input	tp-RES			2	mS
Waiting time to DISP ON from 1st VSYNC 1H= 800 dotclk, 1frame= 480 H, DOTCLK=23MHz	tvsyc-don	16.7			mS
		1			frame

Display condition	Source driver	Gate signals
White display 1	SVSS	VGL
White display 2	Unlit display	Scanning
DISP ON	Normal driving	Scanning

## 8.2 Power down sequence.

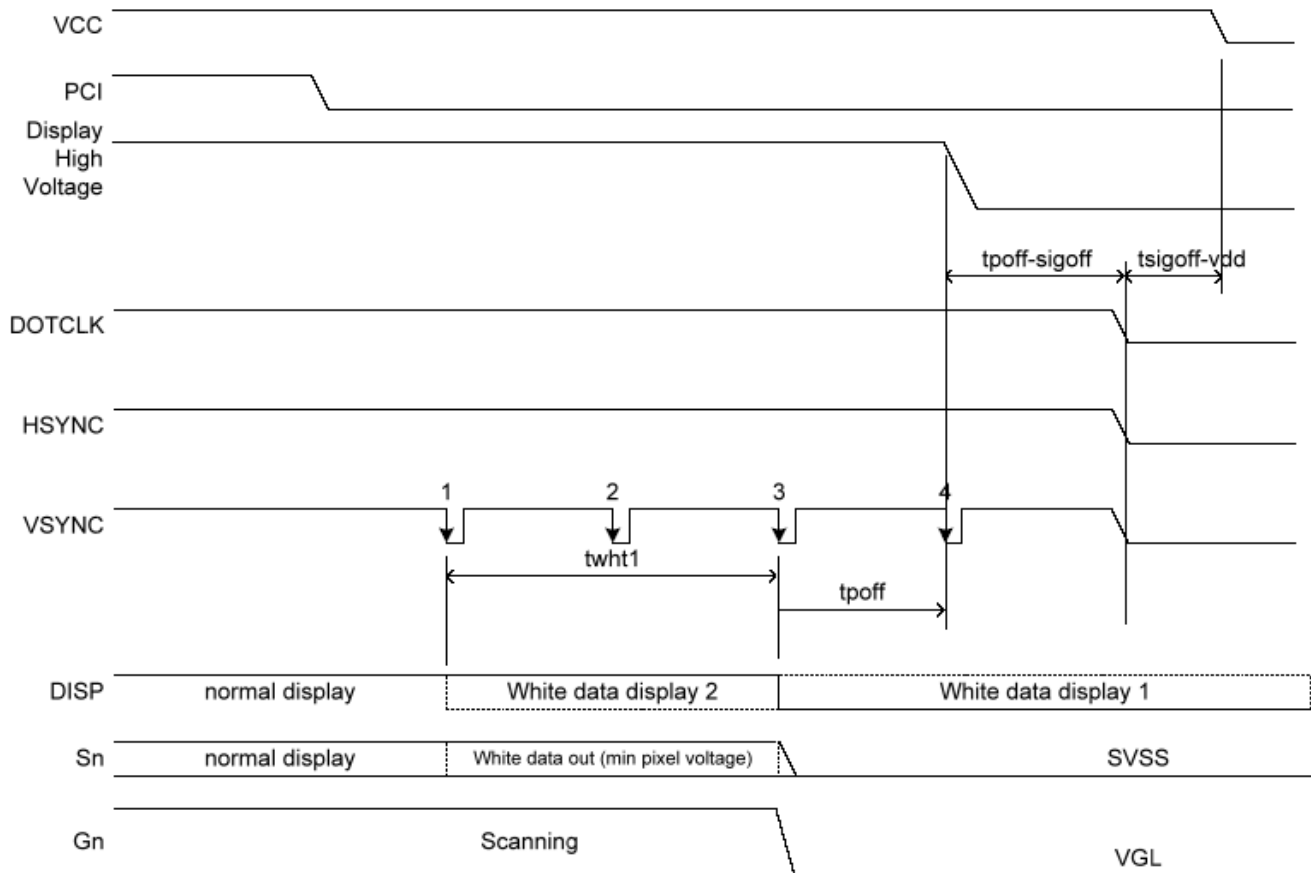

Characteristics	Symbol	MIN	TYP	MAX	Unit
White display 1 period (from 1st VSYNC at PCI=L) 1H= 800 dotclk, 1frame=480 H, DOTCLK=23MHz	twht1	33.3			mS
		2			frame
Power OFF time (from 3rd VSYNC at PCI=L) 1H= 800 dotclk, 1frame=480 H, DOTCLK=23MHz	tpoff	16.7			mS
		1			frame
Signal stop time	tpoff-sigoff	10			CLK
Input-signal-off to VDD/VDC off	tsigoff-vdd	10			mS

**9. Outline Dimension**

- See the next page -

Doc . No	LMS700KF01-001	Rev.No	000	Page	27/31
----------	----------------	--------	-----	------	-------

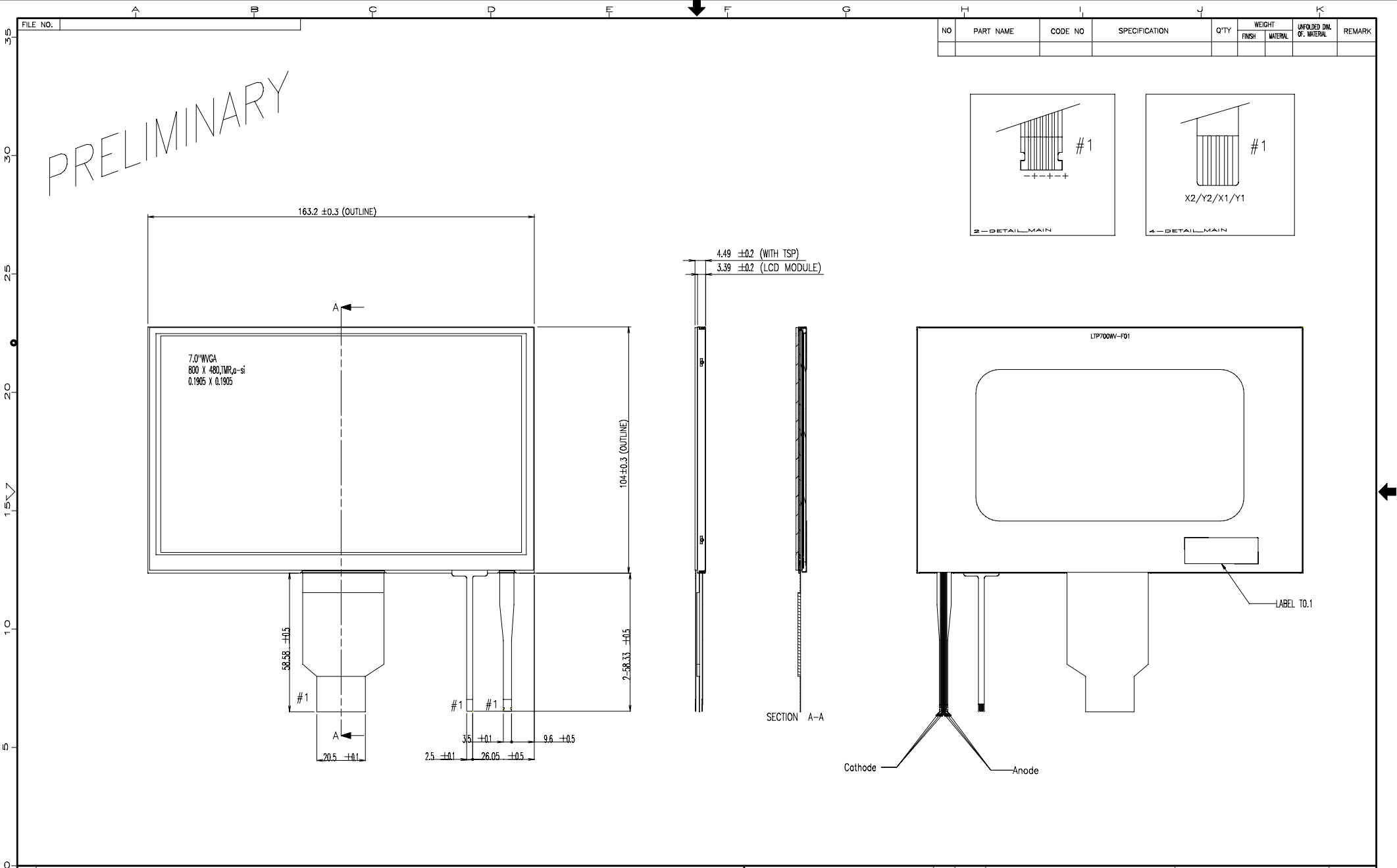

NO	PART NAME	CODE NO	SPECIFICATION	Q'TY	WEIGHT FINISH MATERIAL	UNFOLDED DIM. OF MATERIAL	REMARK

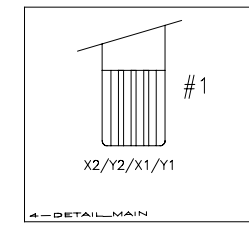
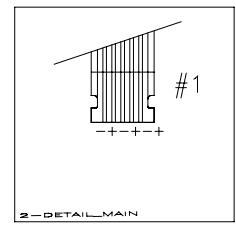

REVISIONS

STEP	GENERAL TOLERANCE		
	LEVEL 1	LEVEL 2	LEVEL 3
0 < X ≤ 4	±0.05	±0.1	±0.2
4 < X ≤ 16	±0.08	±0.15	±0.3
16 < X ≤ 64	±0.12	±0.25	±0.5
64 < X ≤ 256	±0.25	±0.4	±0.8

REV	DATE	DESCRIPTION OF REVISION			REASON		CHK'D BY
UNIT	m	DR'N BY	DES'D BY	CHK'D BY	APP'D BY	MODEL NAME	LTP700W-F01
SCALE	1/1	Y.H.KIM	I.S.LEE	Y.B.CHU		PART/SHEET NAME	OUTLINE DIMENSION SHEET 1/1
TOLERANCE	LEVEL 3	06.11.08	06.11.08	06.11.08		SPEC. NO.	
SAMSUNG ELECTRONICS						CODE NO.	VER. 000

## 10. Packing

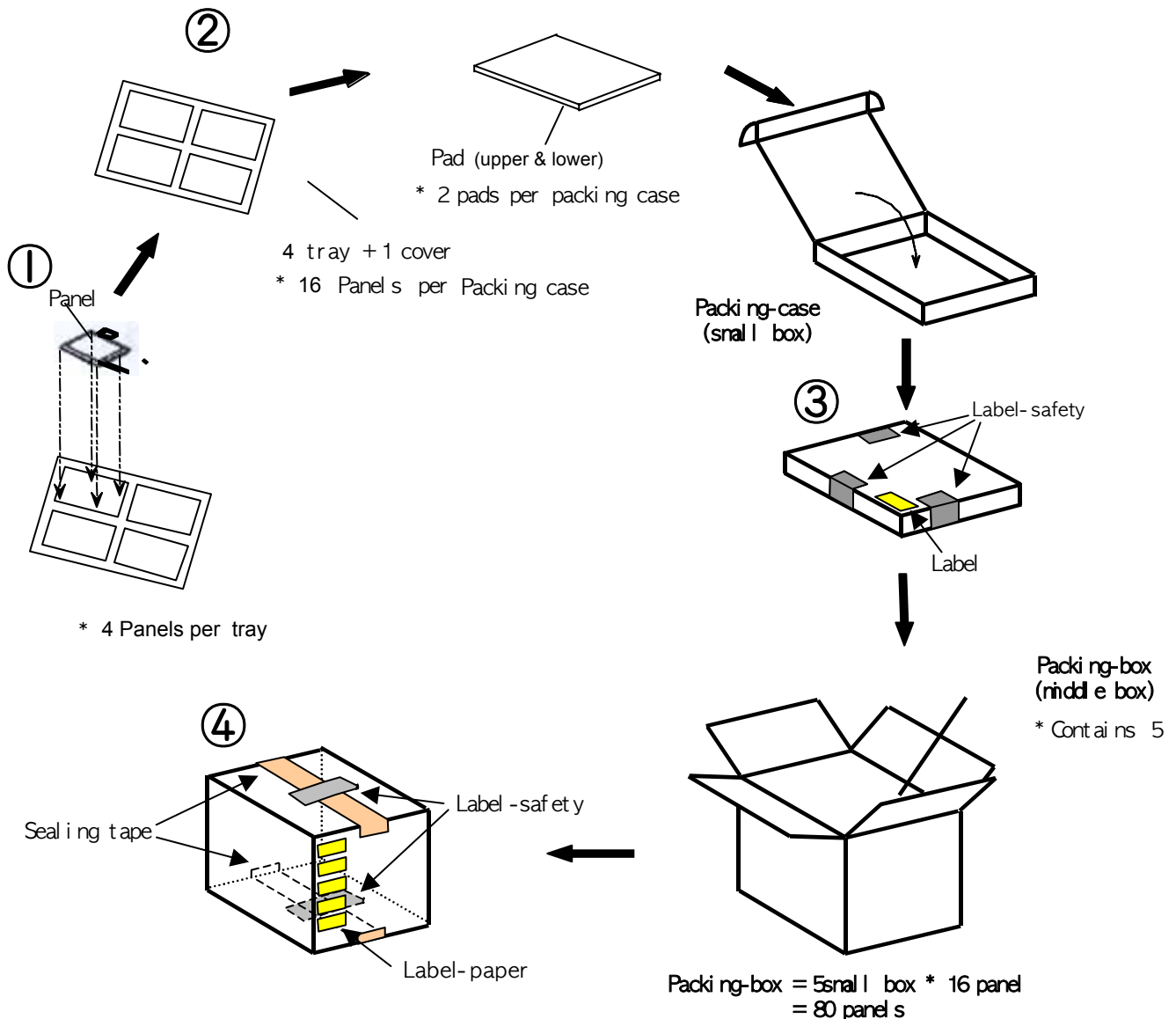

Note (1) Total : Case: Approx. **TBD** Kg

Box: Approx. **TBD** Kg

(2) Size : Case: 490(W) x 342(D) x 58(H)

Box: 505(W) x 355(D) x 312(H)

(3) Place the panels in the tray facing the direction shown in the figure.

(4) Place 4 tray and cover(empty tray) and pads inside the packing-case.

(5) Place 5 packing-case inside the packing-box.(Affix the label)

(6) Seal the packing-box. Affix the label-safety.

## 11. Marking & Others

A nameplate bearing followed by is affixed to a shipped product at the Specified location on each product.

### (1) Module attach

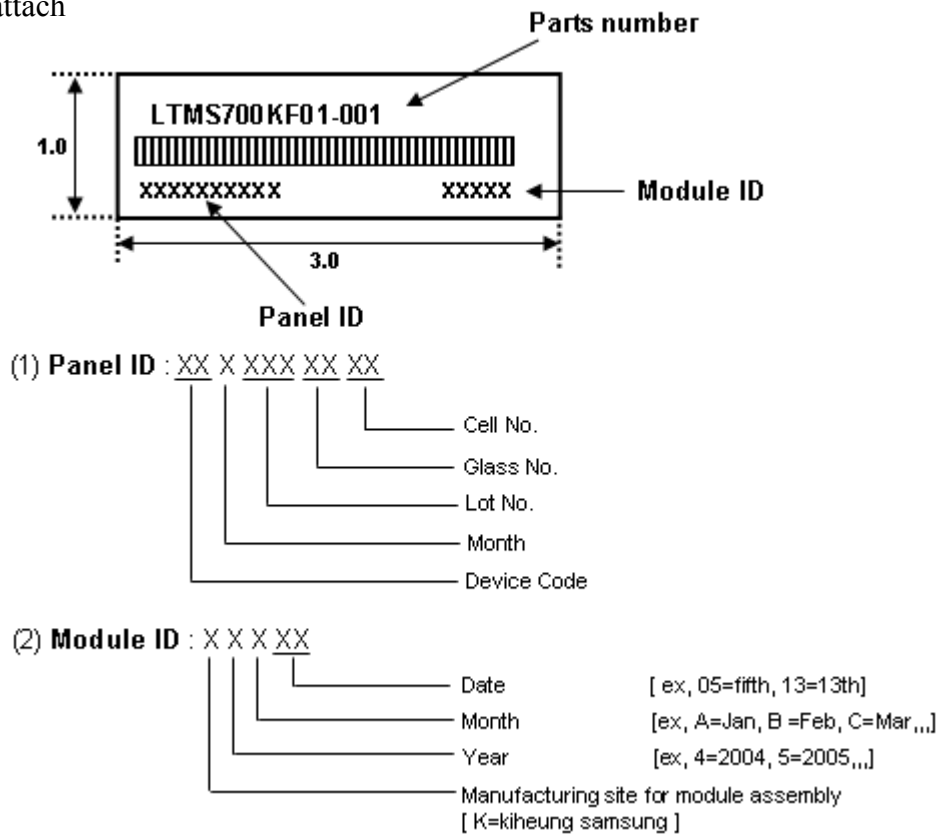

### (2) Packing Case attach

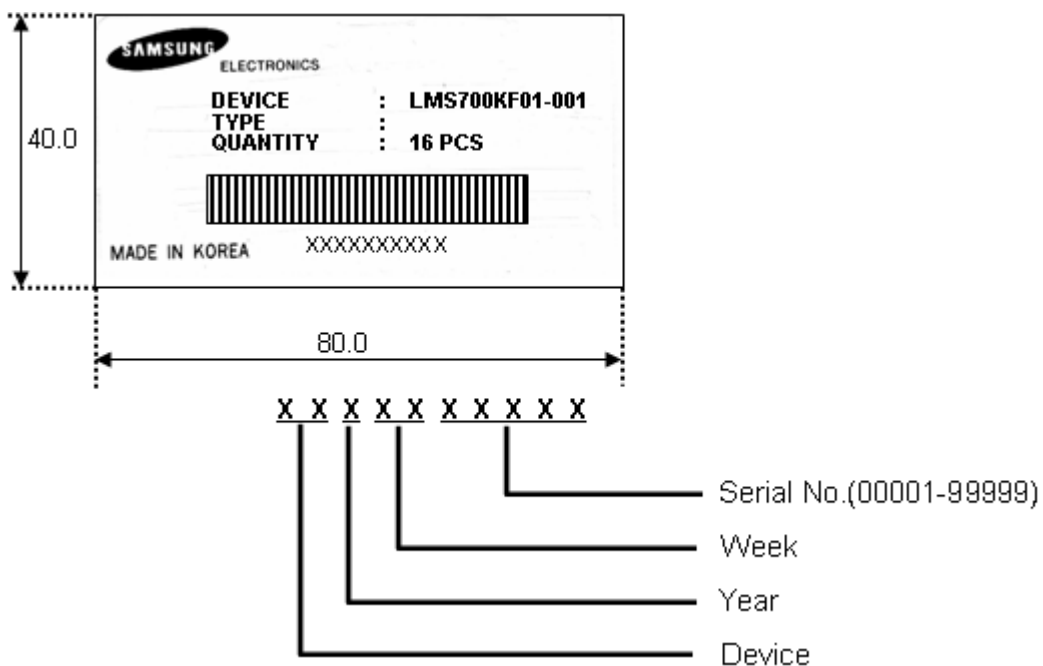

## 12. General Precautions

### 12.1 Handling

- (a) When the module is assembled, it should be attached to the system firmly. Be careful not to twist and bend the module.
- (b) Refrain from strong mechanical shock and / or any force to the module. In addition to damage, this may cause improper operation or damage to the module and back-light unit.
- (c) Note that polarizers are very fragile and could be easily damaged. Do not press or scratch the surface harder than a HB pencil lead.
- (d) Wipe off water droplets or oil immediately. If you leave the droplets for a long time, Staining and discoloration may occur.
- (e) If the surface of the polarizer is dirty, clean it using some absorbent cotton or soft cloth.
- (f) The desirable cleaners are water, IPA(Isopropyl Alcohol) or Hexane. Do not use Ketone type materials(ex. Acetone), Ethyl alcohol, Toluene, Ethyl acid or Methyl chloride. It might permanent damage to the polarizer due to chemical reaction.
- (g) If the liquid crystal material leaks from the panel, it should be kept away from the eyes or mouth. In case of contact with hands, legs or clothes, it must be washed away thoroughly with soap.
- (h) Protect the module from static , it may cause damage to the Integrated Gate Circuit.
- (i) Use finger-stalls with soft gloves in order to keep display clean during the incoming inspection and assembly process.
- (j) Do not disassemble the module.
- (k) Protection film for polarizer on the module shall be slowly peeled off just before use so that the electrostatic charge can be minimized.
- (l) Pins of I/F connector shall not be touched directly with bare hands

## 12.2 Storage

- (a) Do not leave the panel in high temperature, and high humidity for a long time. It is highly recommended to store the module with temperature from 0 to 35°C and relative humidity of less than 70%.
- (b) Do not store the TFT-LCD module in direct sunlight.
- (c) The module shall be stored in a dark place. It is prohibited to apply sunlight or fluorescent light during the store.

## 12.3 Operation

- (a) Do not connect, disconnect the module in the "Power On" condition.
- (b) Power supply should always be turned on/off by the "Power on/off sequence"

## 12.4 Others

- (a) The Liquid crystal is deteriorated by ultraviolet, do not leave it in direct sunlight and strong ultraviolet ray for many hours.
- (b) Avoid condensation of water. It may result in improper operation or disconnection of electrode.
- (c) Do not exceed the absolute maximum rating value. ( the supply voltage variation, input voltage variation, variation in part contents and environmental temperature, and so on) Otherwise the panel may be damaged.
- (d) If the panel displays the same pattern continuously for a long period of time, it can be the situation when the image "Sticks" to the screen.
- (e) This panel has its circuitry FPC on the bottom side and should be handled carefully in order not to be stressed.