

APPROVAL SIGNATURE

SPECIFICATION

FOR

TOSHIBA TFT-LCD MODULE

LTM10C321N

SPECIFICATION No. : _____
NL-LTM10C321N-12

DATE OF ISSUE : 2001-10-24

(DATE OF EXPIRY : 2004-10-24)

T. Nakagawa

Senior Manager

Liquid Crystal Display

Quality Assurance Dept.

Liquid Crystal Display Div.

<Engineering Department to contact as per SPECIFICATION>

Liquid Crystal Display Device Marketing & Engineering Dept.

Liquid Crystal Display Div.

TOSHIBA Corporation

1-9-2, Hatara-cho, Fukaya-shi, Saitama, 366-8510, JAPAN

Revision History

Date	Sheet (New)	Item	Old	New	Reason

Caution and Handling Precaution

For your end user's safety, it is strongly advised that the items with "*" should be included in the instruction manual of the system which may be issued by your organization.

For Safety



Warning

- (1) Toshiba's Standard LCD modules have not been customized for operation in extreme environments or for use in applications where performance failures could be life-threatening or otherwise catastrophic.
Since they must never be installed in aircraft navigation control systems (such as, but not limited to Traffic Collision System and Air traffic Indicator), in military defense or weapons systems, in critical industrial process-control systems (e.g., those involved in the production of nuclear energy), or in critical medical device or patient life-support systems.
- (2) DISCONNECT POWER SUPPLY before handling LCD module.
DO NOT TOUCH the parts inside LCD module and the fluorescent lamp's (hereinafter called "FL") connector or cable in order to prevent electric shock, because high voltage is supplied to these parts from the inverter unit while power supply is turned on.
- (3) Make sure to insert the module FL connector to the inverter connector in correct position.
Do not insert in irregular position.
If incorrect, this may cause smoke or burn of electrical parts by high voltage of FL circuit.
If there is a possibility that the connector has been inserted incorrectly, please re-insert the connector only after you confirm the module and FL power is completely off.
DO NOT USE the mating FL connector which Toshiba does not specify.
Otherwise, Toshiba shall not be liable for any damages caused by the connector.



Caution

- (1) DO NOT DISASSEMBLE OR MODIFY the module.
Sensitive parts inside LCD module may be damaged, and dusts or scratches may mar the displays.
Toshiba does not warrant the modules, if customer disassembled or modified them.
- * (2) DO NOT INGEST liquid crystal material, DO NOT INHALE this material, and DO NOT PERMIT this material to contact the skin, if LCD panel is broken and liquid crystal material spills out.
In the event of inadvertent contact, immediately rinse the mouth or eyes with adequate water. If this material should inadvertently contact the skin or clothing, wash immediately with alcohol and then rinse thoroughly with water.
- * (3) BE CAREFUL WITH CHIPS OF GLASS that may cause injuring fingers or skin, when the glass is broken.
- (4) DO NOT EXCEED the absolute maximum rating values under the worst probable conditions caused by the supply voltage variation, input voltage variation, variation in parts' constants, ambient temperature, etc., otherwise LCD module may be damaged.
- (5) Suitable protection circuit should be applied for each system design.
DO NOT MODIFY the fuse used in the module. It may cause overheat and/or burning if dusts or metal particles are on the PCBs in the LCD module.

- (6) Be sure that power supply output from the system should be limited to smaller values than listed shown below. (For example Quick Arcing Fuse with listed ratings can be used.)

It is because this LCD module explained in this specification has a current limiter, with such function at power input line(s). But it may be some possibility of overheat and/or burning of LCD module and its peripheral devices before current limiter of the module when open-short test of the module is performed by using power supply higher than following recommended value.

Power supply	Recommended maximum Output current of Power supply	Recommended Fuse Rating (In case of using fuse for current limiter)	Built-in Fuse Rating (for reference)
V_{DD}	4.0 A	2.0 A	1.25 A

- (7) Always comply with all applicable environmental regulations, when disposing of LCD.

For Designing the System

- (1) LCD module should be assembled to the system by using all mounting holes specified in this specification and with the specified screws.
- (2) Make sure to design the enclosure that bending/twisting forces are not applied to LCD module during and after the installation into the system.
Make certain clearance between LCD module and system for not press I/F cable, FPC and pipe light guide etc..
- (3) Power supply lines should be designed as follows.
Power supplies should always be turned on before the input signals are supplied to LCD module, and the input signals should be disconnected before power supplies are turned off.
If the sequence does not satisfy specified conditions, it may cause miss-operation of the panel.
Refer to "2.4.2 Sequence of Power Supplies and Signals" for the detailed specification.
- (4) DO NOT GIVE high voltage to "Low Voltage" side of the FL.
For example, DO NOT USE a floating inverter which gives high voltage to "Low Voltage" side. That's because it has a possibility to burn or smoke around the FL.
- (5) Make sure to connect correctly high-voltage wire and low-voltage wire between FL tube and inverter unit.
- (6) Input FL starting voltage (V_{SFL}) should not be less than one second.
If it were less than one second, it may cause unstable operation of FL.
Please adjust inverter circuit parameters, such as capacitor, resistor, to assure the display quality is maintained.
There is a possibility that flicker is observed by the interference of LCD operating signal timing and FL driving condition (especially driving frequency).
- (7) In case of severe environmental condition like outdoor usage, a proper transparent protective cover(lens) over LCD module is recommended to apply in order to prevent scratches, and invasion of dust, water, etc., from the system's window onto LCD module.
Ultra-violet ray cut filter is recommended to apply onto LCD module for outdoor operation. Strong ultra-violet ray may cause damage the panel.
- (8) Design the system not to display same pattern for a long time in order to prevent image sticking on the panel. Note that incorrect sequence of power supplies and input signals may cause the sticking on the panel, too.

For Installation in Assembly

- (1) The C-MOS LSIs used in LCD module are very sensitive to ESD (Electro-static Discharge).
Ambient humidity of working area is recommended to be higher than 50%(RH).
Person handling LCD modules should be grounded with wrist band. Tools like soldering iron and screwdriver, and working benches should be grounded.
The grounding should be done through a resistor of 0.5-1Mohms in order to prevent spark of ESD.
- (2) When remove protection film from LCD panel, peer off the film slowly (more than three seconds) from the edge of the panel, using a soft-pointed tweezers covered by Teflon or adherent tape.
- (3) Reduce dust level in working area. Especially the level of metal particle should be decreased.
Use fingerstalls or soft and dust-free gloves in order to keep clean appearance of LCD module when handled for incoming inspection and assembly.
- * (4) When LCD panel becomes dirty, wipe off the panel surface softly with absorbent cotton or another soft cloth.
If necessary, breathe upon the panel surface and then wipe off immediately and softly again.
If the dirt can not be wiped off, absorbent cotton wetted a little with normal-hexane or petroleum benzine can be used for wiping the panel.
Be careful not to spill this solvent into the inside of LCD module. Driver ICs and PCB area used inside LCD module may be damaged by the solvent.
- * (5) AVOID THE CONDENSATION OF WATER
Wipe off a spot or spots of water of mist and chemicals of mist on LCD panel softly with absorbent cotton or another cloth as soon as possible if happened, otherwise discoloration or stain may be caused. If water invade into LCD module, it may cause LCD module damages.
- * (6) Do not expose LCD module to the gas (which is not normally contained in the atmosphere), it may cause mis-operation or defects.
- * (7) DO NOT APPLY MECHANICAL FORCES.
Do not bend or twist LCD module even momentary when LCD module is installed an enclosure of the system.
Bending or twisting LCD module may cause its damages.
Make sure to design the enclosure that bending/twisting forces are not applied to LCD module when it is installed in the system.
Refrain from strong mechanical shock like dropping from the working bench or knocking against hard object.
These may cause glass of the panel crack, damage of FL or other mis-operation.
- * (8) Refrain from excessive force like pushing the surface of LCD panel. This may cause damage of the panel or electrical parts on PCB.
- * (9) Do not put heavy object such as tools, books, etc., and do not pile up LCD modules.
Be careful not to touch surface of the polarizer laminated to the panel with any hard and sharp object. The polarizer is so soft that it can easily scratched, even the protect film covers it.
- (10) When inserting or disconnecting the connectors to LCD module, be sure not to apply force against PCB, nor connecting cables, otherwise internal connection of PCB and TAB drivers may be damaged.
Do not fasten screws while putting cables like those for interface or FL between LCD module and the enclosure.
Make sure to insert the module FL connector to the inverter connector in correct position.
If incorrect, this may cause smoke or burn of electrical parts by high voltage of FL circuit.

- (11) Be careful not to pull the FL cables of the backlight in order to avoid mechanical damage in FL lamp and soldering area. Be careful not to pull or not to hurt the FPC (Flexible Printed Circuit) cables.
- (12) Power supplies should always be turned off in assembling process.
Do not connect or disconnect the power cables and connectors with power applied to LCD module. This may cause damage of module circuit.
The signal should be applied after powers are turned on. And the signal should be removed before power supplies are turned off. (Refer to "For Designing The System"(2).)
- (13) In case of LCD long period operation, discoloration of light guide or optical sheet will be happened due to ultra violet and heat from CCFL. As the result, there is possibility to have out of specification for the optical characteristics as "4.3.2". But this is not irregular phenomena.
Moreover, CCFL also has the characteristic of color shift by long period operation.

For Transportation and Storage

- (1) Do not store LCD module in high temperature, especially in high humidity for a long time (approximately more than one month).
It is recommended to store LCD module where the temperature is in the range of 0 to 35 degrees Celsius and the relative humidity is lower than 70%.
- (2) Store LCD module without exposure to direct sunlight or fluorescent lamps in order to prevent the module from strong ultra violet ray.
- * (3) Avoid condensation of water on LCD module, otherwise it may cause mis-operation or defects. Keep away LCD module from such ambient.
- (4) In case of transportation of storage after opening the original packing. LCD module is recommended to be repacked into the original packaging with the same method, especially with same kind of desiccant.

- CONTENTS -

Revision History	Sheet	1
Caution and Handling Precaution		2
1. Scope		7
2. Product Specifications		7
2.1 General Specifications			
2.2 Absolute Maximum Ratings			
2.3 Mechanical Specifications			
2.3.1 Weight			
2.3.2 Dimensional Outline			
2.4 Electrical Specifications			
2.4.1 Circuit Diagram			
2.4.2 Sequence of Power Supplies and Signals			
2.4.3 Timing Chart			
2.4.4 Timing Specifications			
2.4.5 Interface Connector			
2.4.6 Colors Combination Table			
3. Recommended Operating Conditions		18
4. Electrical Characteristics		19
4.1 Test Conditions			
4.2 Specifications			
5. Optical Characteristics		20
5.1 Test Conditions			
5.2 Optical Specifications			
6. Quality		21
6.1 Appearance Test			
6.1.1 Test Conditions			
6.1.2 Specifications			
6.2 Display Quality			
6.2.1 Test Conditions			
6.2.2 Specifications			
6.3 Reliability Test			
6.3.1 Test Conditions			
6.3.2 Specifications			
6.4 Labels			
7. Lifetime		25
7.1 Module			
7.2 Lamp			
7.2.1 Test Conditions			
7.2.2 Specifications			
8. Packaging		26
8.1 Carton			
9. Warranty		28
10. Regulation		28
11. Measuring Method		28
11.1 Measuring Systems			
11.2 Measuring Methods			

1. Scope

This specification is applicable to Toshiba's 26cm diagonal size TFT-LCD module "LTM10C323N" designed for Personal Computer.

2. Product Specifications

2.1 General Specifications

Item	Specifications
Display Mode	TN color(64 gray scales, 256k colors) Transmissive type, Normally white (∴ k=1024)
Optimum Viewing Direction	6 o'clock (in direction of maximum contrast)
Driving Method	TFT active matrix
Input Signals	LVDS interface CLK+,CLK- IN0+,IN0- IN1+,IN1- IN2+,IN2- *Not use Hsync or Vsync. Only ENAB control.
Dimensional Outline ¹⁾	238.6 (W) × 173.2 (H) × 5.0max. (D) (mm)
Viewing Area	214.1 (W) × 161.3 (H) (mm)
Number of Pixels ²⁾	1024 (W) × 768 (H) (mm)
Pixel Pitch ²⁾	0.2055 (W) × 0.2055 (H) (mm)
Pixel Arrangement ²⁾	RGB vertical stripes
Surface Treatment	Anti-glare and hard coat 3H on LCD surface
Backlight	Single cold-cathode fluorescent lamp for sidelighting

Note 1) Excluding backlight cables.

Note 2)

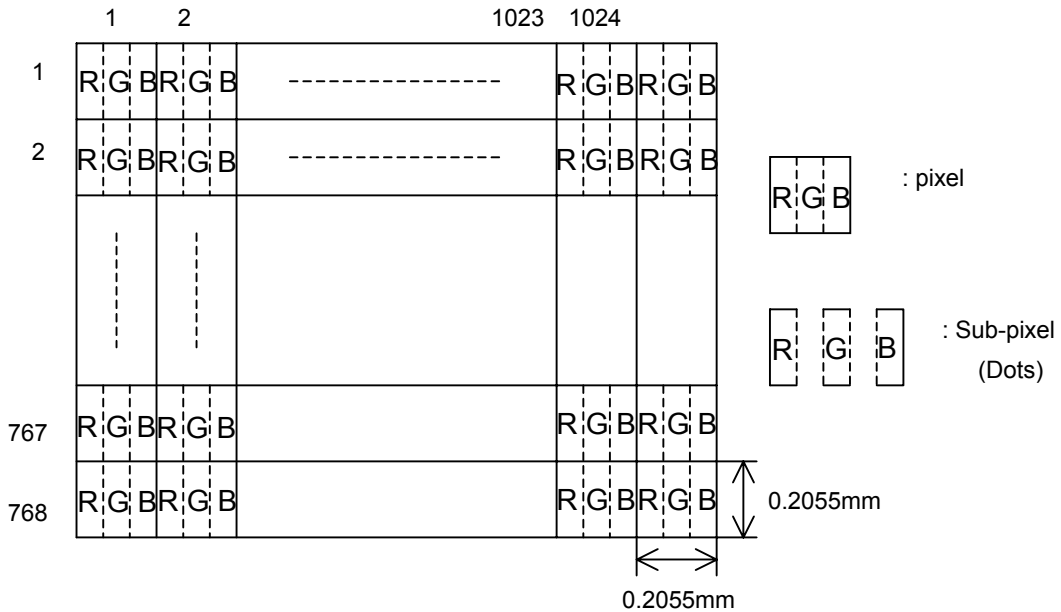

2.2 Absolute Maximum Ratings ¹⁾

Item	Symbol	Min.	Max.	Unit	Checked Terminal ⁴⁾
Supply Voltage	V_{DD}	-0.3	+4.0	V	$V_{DD} - GND$
Input Voltage of Signals	V_{IN}	-0.3	$V_{DD}+0.3$	V	LVDS interface
FL Driving Voltage	V_{FL}	-	2.0	kVrms	
FL Driving Frequency	f_{FL}	0	100	kHz	
Operating Ambient Temperature ²⁾	T_{OP}	0	+50	°C	
Operating Ambient Humidity ²⁾	H_{OP}	10	90	%(RH)	
Storage Temperature ²⁾	T_{STG}	-20	+60	°C	
Storage Humidity ²⁾	H_{STG}	10	90	%(RH)	
Operating Temperature for Panel ³⁾	-	0	+60	°C	

Note1) Do not exceed the maximum rating values under the worst probable conditions taking into account the supply voltage variation, input voltage variation, variation in part constants, and ambient temperature and so on. Otherwise the module may be damaged.

2) Wet bulb temperature should be 39°C Max, and no condensation of water. See figure below.

3) The surface temperature caused by self heat radiation of cell itself is specified on this item.

4) Refer to 2.4.5

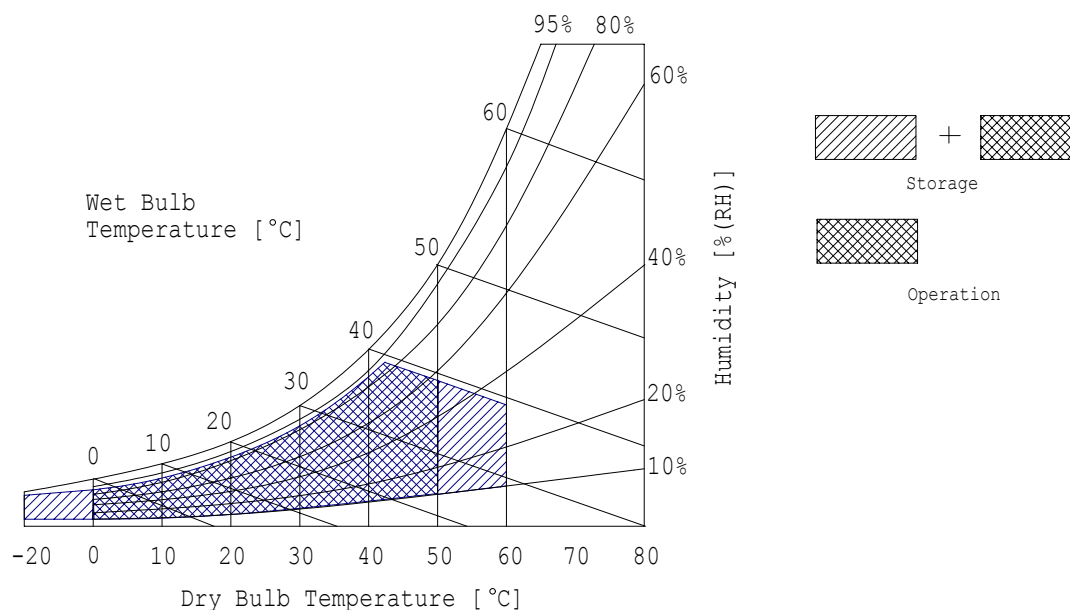

2.3 Mechanical Specifications

2.3.1 Weight

220 ± 20 (g)

2.3.2 Dimensional Outline
(front figure)

Unit : mm

Standard Tolerance : ±0.5

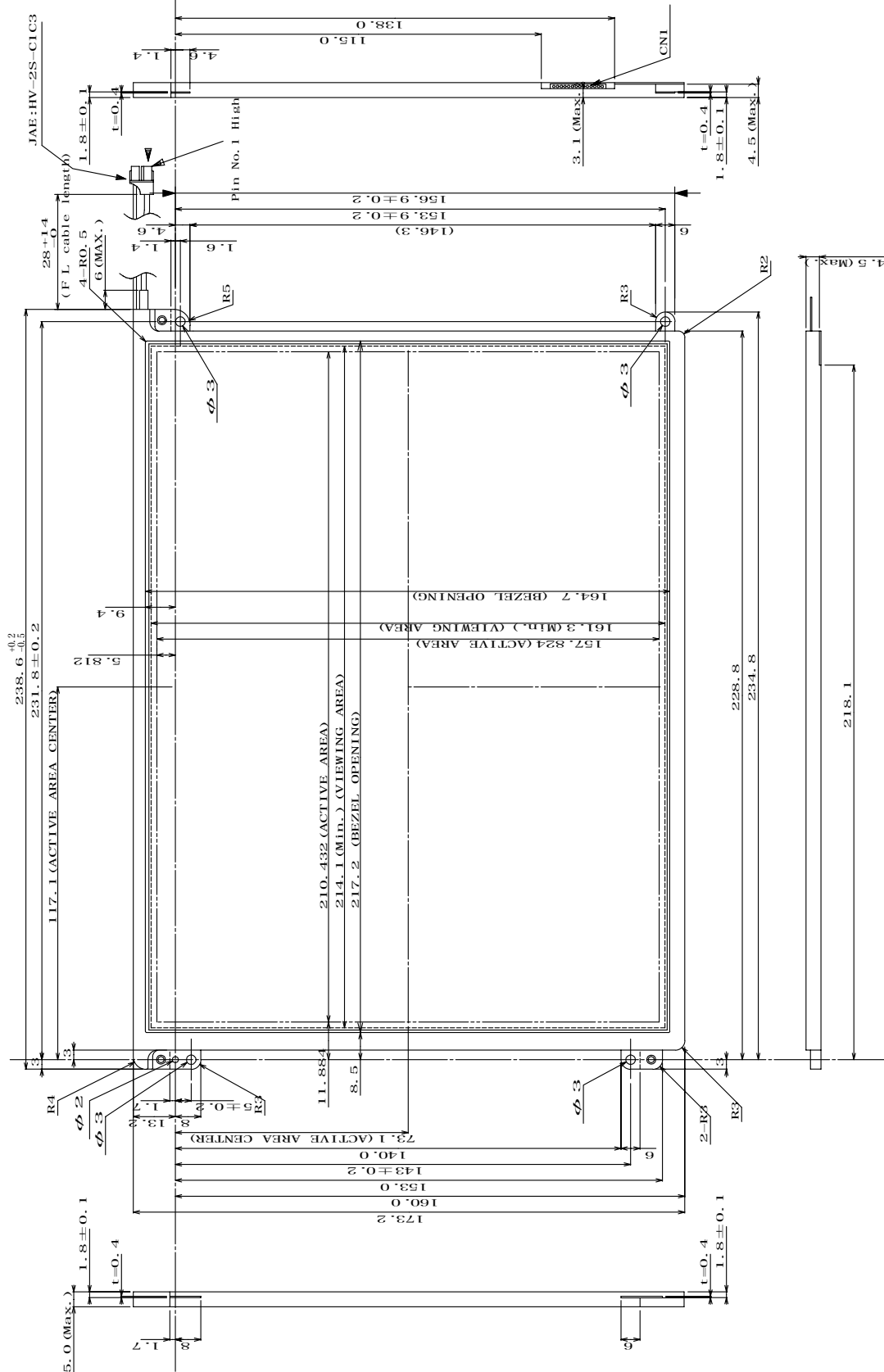

(back figure)

Unit : mm

Standard Tolerance : ± 0.5

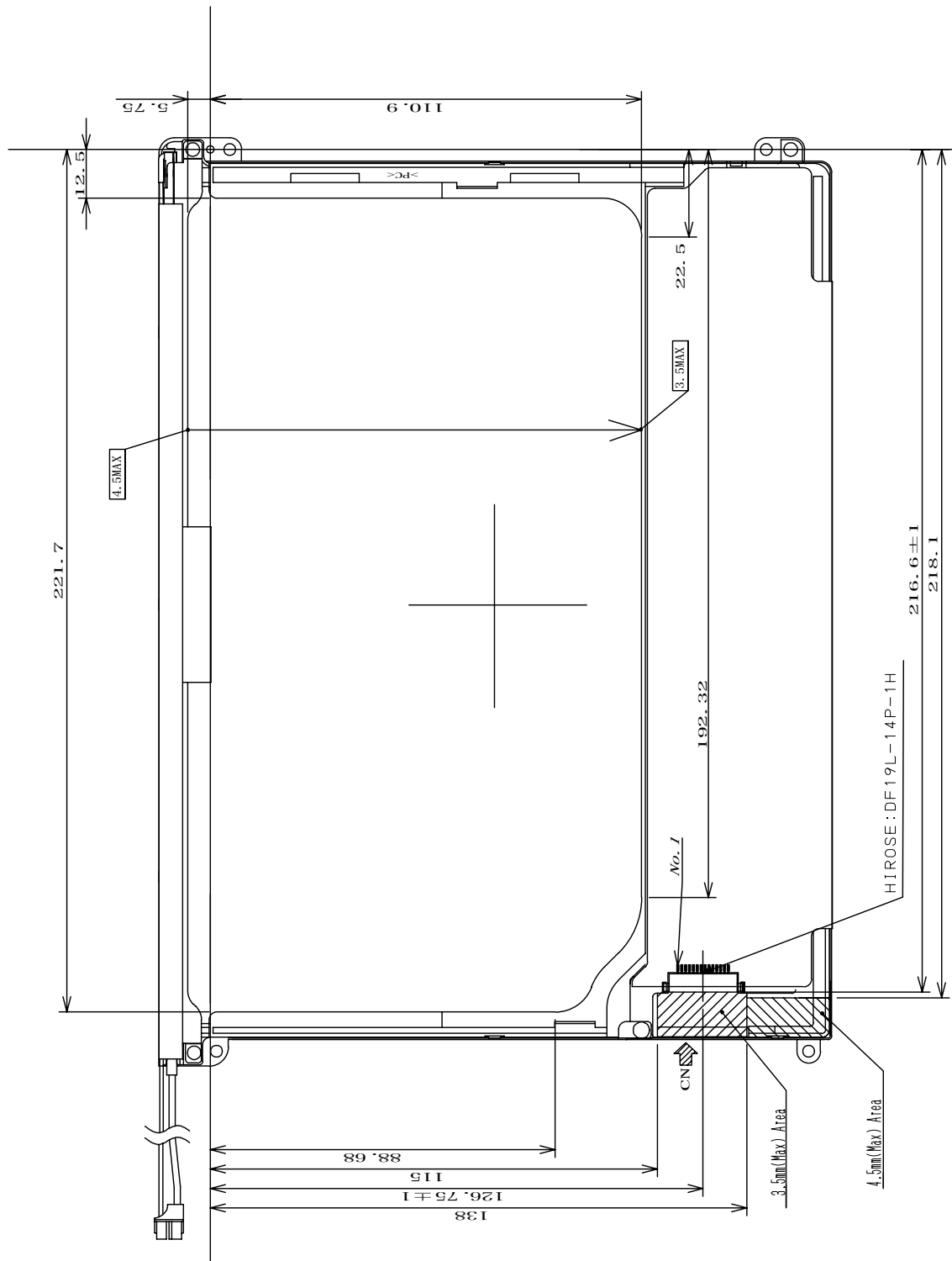

2.4 Electrical Specifications

2.4.1 Circuit Diagram

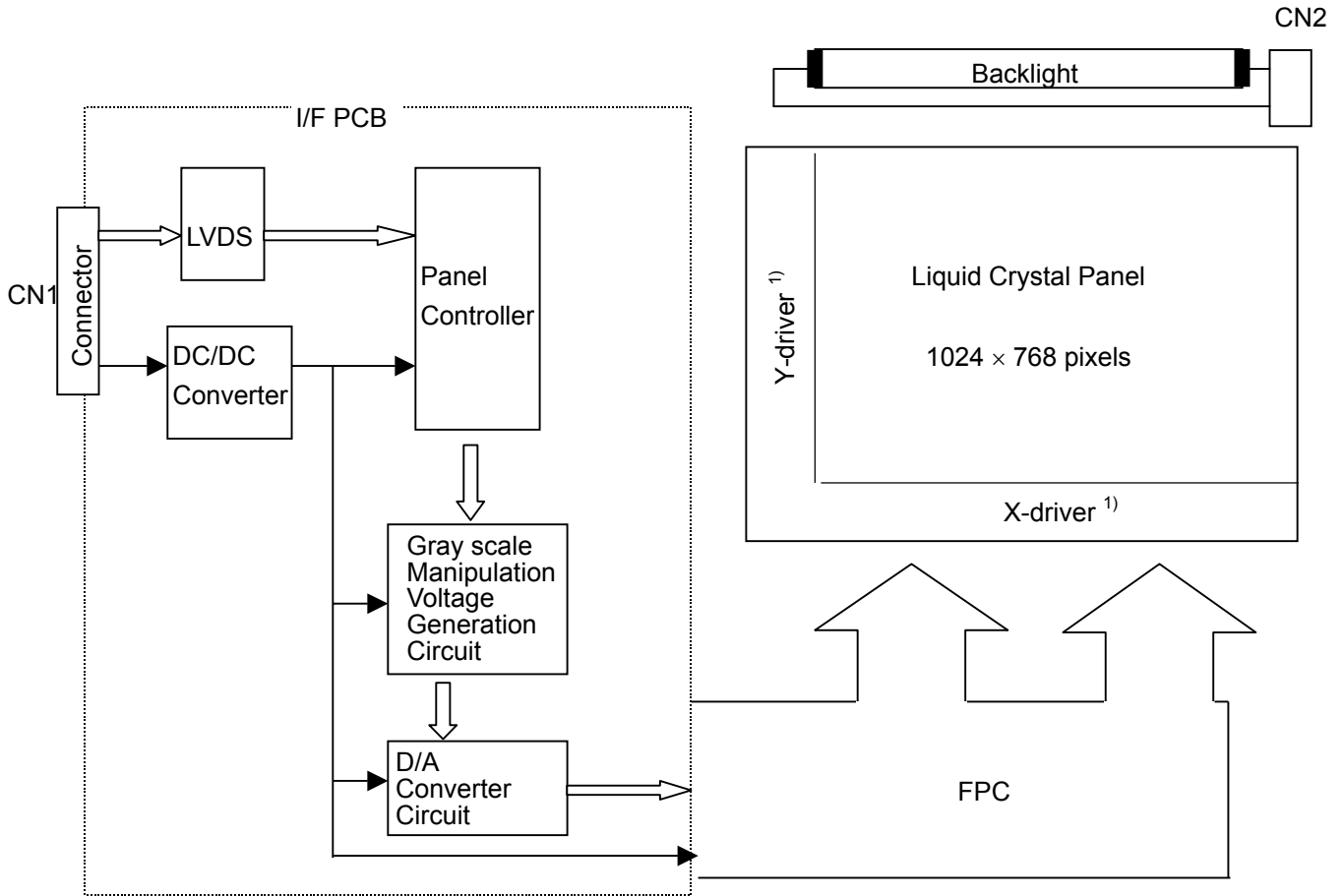

Note 1) Build up LCD drivers on the glass substrate

2.4.2 Sequence of Power Supplies and Signals

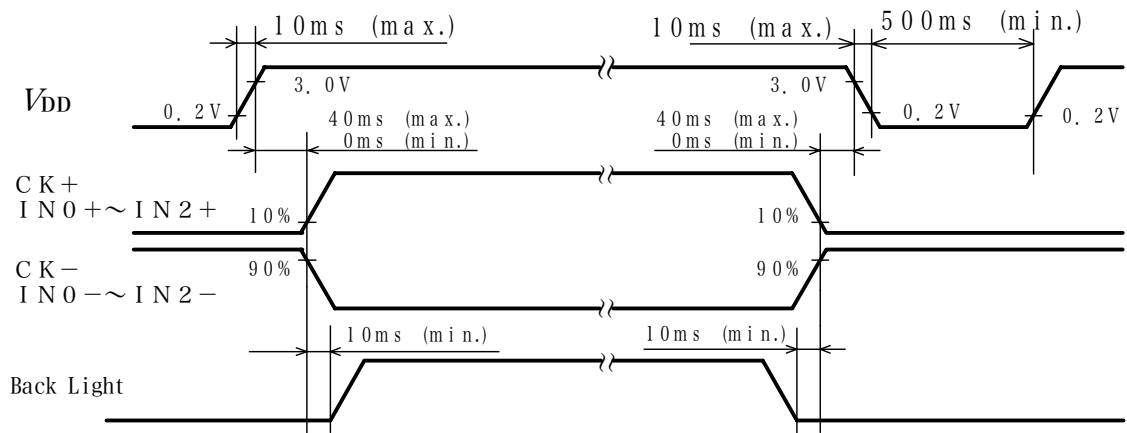

2.4.3 Timing Chart

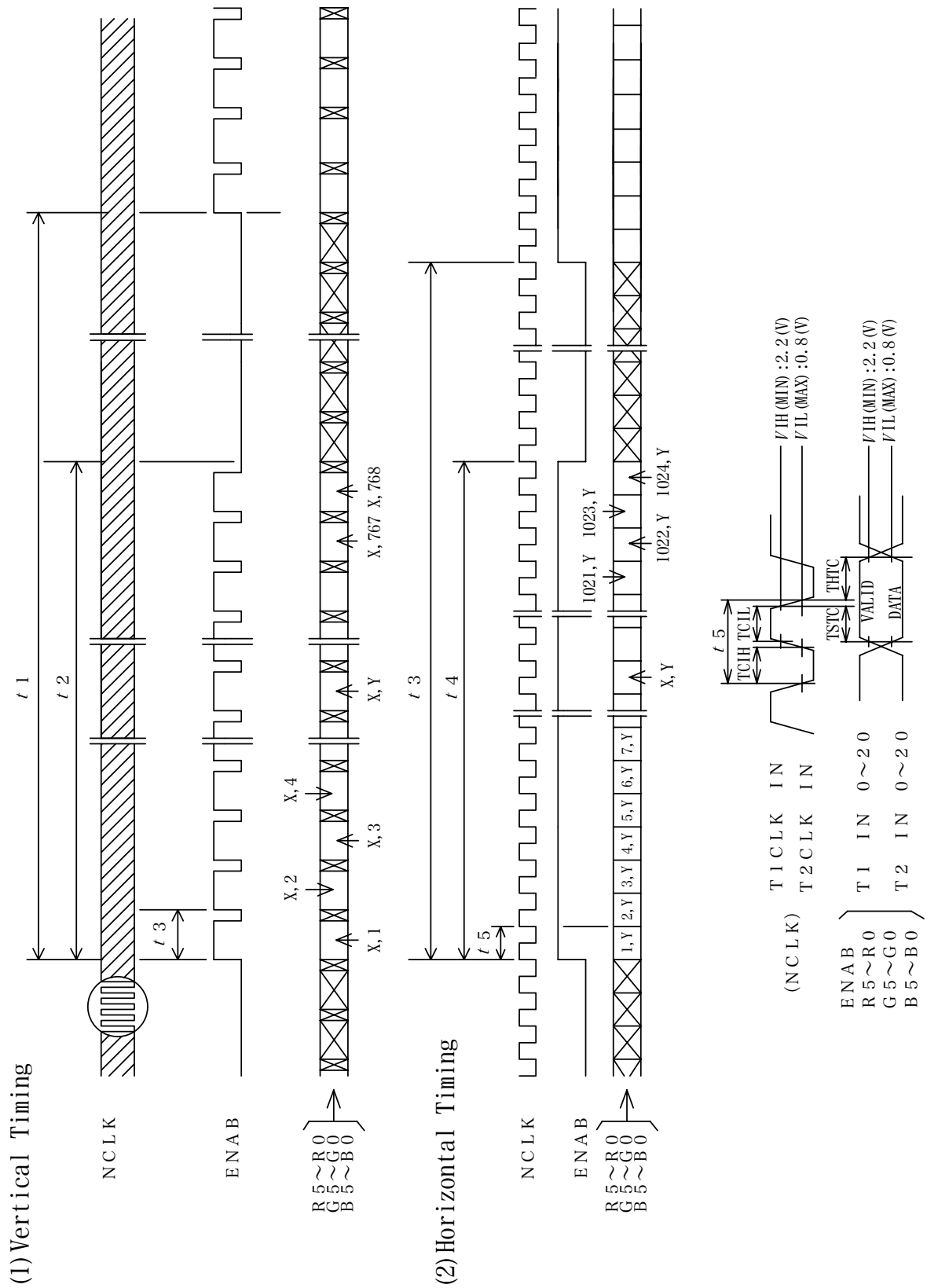

2.4.4 Timing Specifications ^{1) 2) 3) 4) 5) 6) 7) 8)}

Item	Symbol	Min.	Typ.	Max.	Unit	Remarks
Frame Period	$t1$	$778 \times f3$ -	$806 \times f3$ 16.67	$860 \times f3$ 17.78	- ms	
Vertical Display Term	$t2$	$768 \times f3$	$768 \times f3$	$768 \times f3$	-	
One Line Scanning Time	$t3$	$1336 \times f5$ 20.0	$1344 \times f5$ 20.68	$1462 \times f5$	- μ s	
Horizontal Display Term	$t4$	$1024 \times f5$	$1024 \times f5$	$1024 \times f5$	-	
Clock Period	$t5$	15.0	15.38	-	ns	

Note 1) Refer to "2.4.3 Timing Chart" and LVDS (DF90CF364MTD) specifications by National Semiconductor.

Note 2) If ENAB is fixed to "H" or "L" level for certain period while NCLK is supplied, the panel displays black with some flicker.

Note 3) Do not hold NCLK on "H" level nor "L" level during VDD(+3.3V) is supplied.

If NCLK is fixed to "H" or "L" level for certain period while ENAB is supplied, the panel may be damaged.

When It holds on, DC voltage supplies to liquid crystal materials and It may cause damage to liquid crystal materials.

Graphic controller 69000 (Chips & Technology), for example, causes above phenomenon.

Note 4) Please adjust LCD operating signal timing and FL driving frequency, to optimize the display quality.

There is a possibility that flicker is observed by the interference of LCD operating signal timing and FL driving Condition (especially driving frequency), even if the condition satisfies above timing specifications and recommended operating conditions shown in 3.

Note 5) Do not make $t1, t2$ and $t3$ fluctuate.

If $t1, t2$ and $t3$ are fluctuate, the panel displays black.

Note 6) Keep constant the number of clock within one line scanning time and the number of scanning line within one flame period.

Note 7) V-Blanking period should be " $n \times$ Horizontal Scanning Time".(n : integer)

Notes8)In case of using the long frame period,the deterioration of display quality,noise etc. may be occurred/

2.4.5 Interface Connector

CN1 INPUT SIGNAL

Using Connector : DF19L-14P-1H / HIROSE ELECTRIC CO.,LTD.

Mating Connector(Corresponding Connector)

: DF19G-14S-1C / HIROSE ELECTRIC CO.,LTD.

Terminal No.	Symbol	Function
1	V _{DD}	Power Supply : +3.3V
2	V _{DD}	Power Supply : +3.3V
3	GND ¹⁾	
4	GND ¹⁾	
5	IN0-	Transmission Data of Pixels(Differential data) 0 (Negative : -)
6	IN0+	Transmission Data of Pixels(Differential data) 0 (Positive : +)
7	IN1-	Transmission Data of Pixels(Differential data) 1 (Negative : -)
8	IN1+	Transmission Data of Pixels(Differential data) 1 (Positive : +)
9	IN2-	Transmission Data of Pixels(Differential data) 2 (Negative : -)
10	IN2+	Transmission Data of Pixels(Differential data) 2 (Positive : +)
11	CLK-	Sampling Clock (Negative : -)
12	CLK+	Sampling Clock (Positive : +)
13	GND ¹⁾	
14	GND ¹⁾	

CN2 CCFL POWER SOURCE

Using Connector : HV-2S-C1C3 / Japan Aviation Electronics Industry.,LTD.

Mating Connector(Corresponding Connector)

: HV-2P-HF / Japan Aviation Electronics Industry.,LTD

Terminal No.	Symbol	Function
1	VFLH	CCFL Power Supply (high voltage)
2	VFLL	CCFL Power Supply (low voltage)

Note 1) Please connect GND pin to ground.

Don't use it as no-connect nor connection with high impedance.

RECOMMENDED TRANSMITTER(DS90C363) TO LTM10C321N INTERFACE ASSIGNMENT

Case1: 6Bit TRANSMITTER

Input Terminal No.		Input Signal (Graphics controller output signal)		Output Signal Symbol	To LTM12C505 Interface(CN1)	
Symbol	DS90CF363	Symbol	Function		Terminal	Symbol
TIN0	44	R0	Red Pixels Display Data (LSB)	TOUT0- TOUT0+	No.5 No.6	IN0- IN0+
TIN1	45	R1	Red Pixels Display Data			
TIN2	47	R2	Red Pixels Display Data			
TIN3	48	R3	Red Pixels Display Data			
TIN4	1	R4	Red Pixels Display Data			
TIN5	3	R5	Red Pixels Display Data (MSB)			
TIN6	4	G0	Green Pixels Display Data (LSB)	TOUT1- TOUT1+	No.8 No.9	IN1- IN1+
TIN7	6	G1	Green Pixels Display Data			
TIN8	7	G2	Green Pixels Display Data			
TIN9	9	G3	Green Pixels Display Data			
TIN10	10	G4	Green Pixels Display Data			
TIN11	12	G5	Green Pixels Display Data (MSB)			
TIN12	13	B0	Blue Pixels Display Data (LSB)	TOUT2- TOUT2+	No.11 No.12	IN2- IN2+
TIN13	15	B1	Blue Pixels Display Data			
TIN14	16	B2	Blue Pixels Display Data			
TIN15	18	B3	Blue Pixels Display Data			
TIN16	19	B4	Blue Pixels Display Data			
TIN17	20	B5	Blue Pixels Display Data (MSB)			
TIN18	22	NC	Non Connection (open)	TCLK OUT- TCLK OUT+	No.14 No.15	CLK IN- CLK IN+
TIN19	23	NC	Non Connection (open)			
TIN20	25	ENAB	Compound Synchronization Signal			
CLK IN	26	NCLK	Data Sampling Clock			

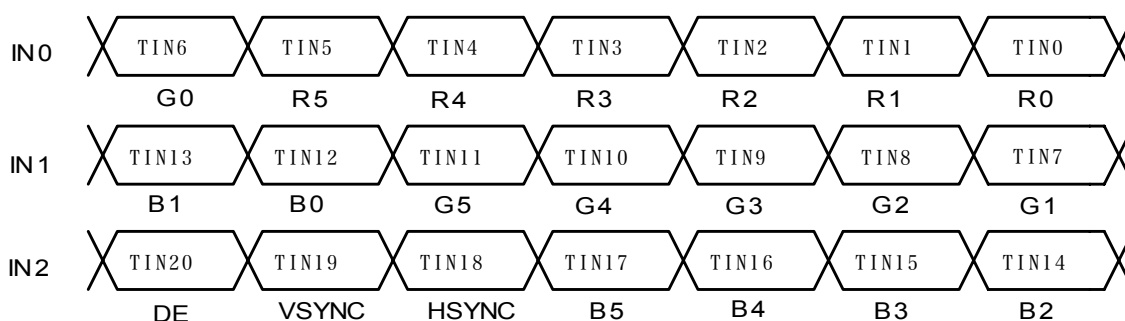

RECOMMENDED TRANSMITTER(DS90C383) TO LTM10C321N INTERFACE ASSIGNMENT

Case2: 8Bit TRANSMITTER

Input Terminal No.		Input Signal (Graphics controller output signal)		Output Signal Symbol	To LTM12C505 Interface(CN1)	
Symbol	DS90CF383	Symbol	Function		Terminal	Symbol
TIN0	51	R0	Red Pixels Display Data (LSB)	TOUT0- TOUT0+	No.5 No.6	IN0- IN0+
TIN1	52	R1	Red Pixels Display Data			
TIN2	54	R2	Red Pixels Display Data			
TIN3	55	R3	Red Pixels Display Data			
TIN4	56	R4	Red Pixels Display Data			
TIN6	3	R5	Red Pixels Display Data (MSB)	TOUT1- TOUT1+	No.8 No.9	IN1- IN1+
TIN7	4	G0	Green Pixels Display Data(LSB)			
TIN8	6	G1	Green Pixels Display Data			
TIN9	7	G2	Green Pixels Display Data			
TIN12	11	G3	Green Pixels Display Data			
TIN13	12	G4	Green Pixels Display Data	TOUT2- TOUT2+	No.11 No.12	IN2- IN2+
TIN14	14	G5	Green Pixels Display Data(MSB)			
TIN15	15	B0	Blue Pixels Display Data (LSB)			
TIN18	19	B1	Blue Pixels Display Data			
TIN19	20	B2	Blue Pixels Display Data			
TIN20	22	B3	Blue Pixels Display Data	TOUT3- TOUT3+	-	-
TIN21	23	B4	Blue Pixels Display Data			
TIN22	24	B5	Blue Pixels Display Data (MSB)			
TIN24	27	NC	Non Connection (open)			
TIN25	28	NC	Non Connection (open)			
TIN26	30	ENAB	Compound Synchronization Signal	TCLK OUT- TCLK OUT+	No.14 No.15	CLK IN- CLK IN+
TIN27	50	NC	Non Connection (open)			
TIN5	2	NC	Non Connection (open)			
TIN10	8	NC	Non Connection (open)			
TIN11	10	NC	Non Connection (open)			
TIN16	16	NC	Non Connection (open)			
TIN17	18	NC	Non Connection (open)			
TIN23	25	NC	Non Connection (open)			
CLK IN	31	NCLK	Data Sampling Clock			

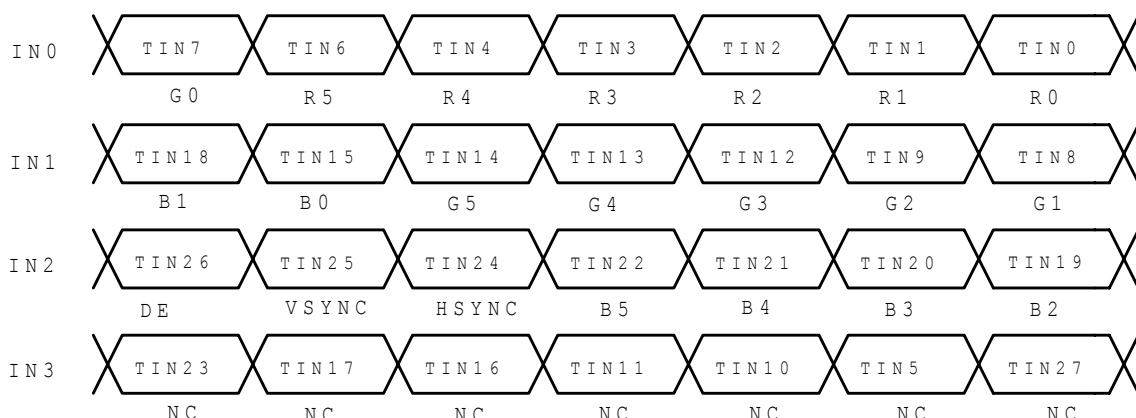

2.4.6 Colors Combination Table

	Display	R5 R4 R3 R2 R1 R0	G5 G4 G3 G2 G1 G0	B5 B4 B3 B2 B1 B0	Gray Scale Level
Basic Color	Black	L L L L L L L	L L L L L L L	L L L L L L L	-
	Blue	L L L L L L L	L L L L L L L	H H H H H H H	-
	Green	L L L L L L L	H H H H H H H	L L L L L L L	-
	Light Blue	L L L L L L L	H H H H H H H	H H H H H H H	-
	Red	H H H H H H H	L L L L L L L	L L L L L L L	-
	Purple	H H H H H H H	L L L L L L L	H H H H H H H	-
	Yellow	H H H H H H H	H H H H H H H	L L L L L L L	-
	White	H H H H H H H	H H H H H H H	H H H H H H H	-
Gray Scale of Red	Black	L L L L L L L	L L L L L L L	L L L L L L L	L 0
	Dark ↑ ↓ Light	L L L L L H L	L L L L L L L	L L L L L L L	L 1
		L L L L L L L	L L L L L L L	L L L L L L L	L 2
		: : :	: : :	: : :	L3... L60
		H H H H L H L	L L L L L L L	L L L L L L L	L61
		H H H H H L L	L L L L L L L	L L L L L L L	L62
	Red	H H H H H H H	L L L L L L L	L L L L L L L	Red L63
Gray Scale of Green	Black	L L L L L L L	L L L L L L L	L L L L L L L	L 0
	Dark ↑ ↓ Light	L L L L L L L	L L L L L L H	L L L L L L L	L 1
		L L L L L L L	L L L L L H L	L L L L L L L	L 2
		: : :	: : :	: : :	L3... L60
		L L L L L L L	H H H H L H L	L L L L L L L	L61
		L L L L L L L	H H H H H L L	L L L L L L L	L62
	Green	L L L L L L L	H H H H H H H	L L L L L L L	Green L63
Gray Scale of Blue	Black	L L L L L L L	L L L L L L L	L L L L L L L	L 0
	Dark ↑ ↓ Light	L L L L L L L	L L L L L L L	L L L L L H L	L 1
		L L L L L L L	L L L L L L L	L L L L H L L	L 2
		: : :	: : :	: : :	L3... L60
		L L L L L L L	L L L L L L L	H H H H L H L	L61
		L L L L L L L	L L L L L L L	H H H H H L L	L62
	Blue	L L L L L L L	L L L L L L L	H H H H H H H	Blue L63
Gray Scale of White & Black	Black	L L L L L L L	L L L L L L L	L L L L L L L	L 0
	Dark ↑ ↓ Light	L L L L L H L	L L L L L L H	L L L L L H L	L 1
		L L L L L H L	L L L L L H L	L L L L H L L	L 2
		: : :	: : :	: : :	L3... L60
		H H H H L H L	H H H H L H L	H H H H L H L	L61
		H H H H H L L	H H H H H L L	H H H H H L L	L62
	White	H H H H H H H	H H H H H H H	H H H H H H H	White L63

Note1 L: Low level voltage, H: High level voltage

3. Recommended Operating Conditions ¹⁾²⁾³⁾

Item	Symbol	Min.	Typ.	Max.	Unit	Remarks
Supply Voltage ⁴⁾	V_{DD}	3.0	3.3	3.6	V	
Receiver Input Range		0	-	2.4	V	
Differential Input High Threshold ⁵⁾	V_{TH}	-	-	$V_{OS}+0.1$	V	V_{OS} :Offset Mode Voltage $V_{OS}=1.2V$
Differential Input Low Threshold ⁵⁾	V_{TL}	$V_{OS}-0.1$	-	-	V	
FL Input Current ⁶⁾⁷⁾⁸⁾	I_{FL}	2.5	5.0	6.0	mA(rms)	
FL Driving Voltage ⁶⁾	V_{FL}	540	590	640	V(rms)	$I_{FL}=5.0mA(rms)$ (Reference)
FL Driving Frequency ⁶⁾⁹⁾	f_{FL}	40	50	60	kHz	
FL Starting Voltage ⁶⁾¹⁰⁾	V_{SFL}	1200	-	1600	V(rms)	

Note 1) The module should be always operated within these ranges. The "Typ." shows the recommendable value.

Note 2) Recommended LVDS transmitter : DF90CF363MTD,DF90CF383MTD(made by National Semiconductor)
LVDS receiver included in this module is DF90CF364MTD.

Refer to LVDS specifications.

Note 3) This TFT-LCD module conforms to LVDS standard TIA/EIA-644

Note 4) Checked Pin Terminal: V_{DD} ,GND(0V)

Note 5) Checked Pin Terminal:IN0- ~ CLK+,GND(0V)

Note 6) Checked Pin Terminal:VFLH-VFLL

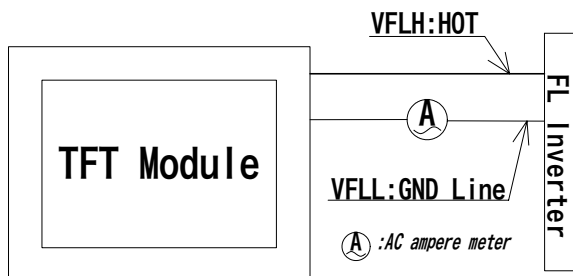

Note 7) If FL input current is higher than 6.0mA(rms), then FL lifetime becomes shorter.

Note 8) Measuring Method of I_{FL}

Note 9) Please adjust LCD operating signal timing and FL driving frequency, to optimize the display quality.

There is a possibility that flicker is observed by the interference of LCD operating signal timing and FL driving condition (especially driving frequency), even if the condition satisfies above recommended operating conditions and timing specifications shown in 2.4.4.

Note10) Input FL starting voltage(V_{SFL}) should not be less than one second.

If it were less than one second, it may cause unstable operation of FL.

4. Electrical Characteristics

4.1 Test Conditions

Ambient Temperature : T_a 25±5°C

Ambient Humidity : H_a 65±20%(RH)

Supply Voltage : V_{DD} 3.3V

Input Signal : Refer typical value in "2.4.4 Timing Specifications".

FL Input Current : I_{FL} 5.0mA(rms)

FL Driving Frequency : f_{FL} 50kHz

4.2 Specifications

Item	Symbol	Min.	Typ. ¹⁾	Max.	Unit	Remark
Current Consumption (Current Dissipation)	I_{DD}	-	230	380	mA	V_{DD} Terminal Current

Note 1) The Typical value of I_{DD} is measured in the following pattern.

- 1. White
- 2. Yellow
- 3. Purple
- 4. Red
- 5. Light Blue
- 6. Green
- 7. Blue
- 8. Black

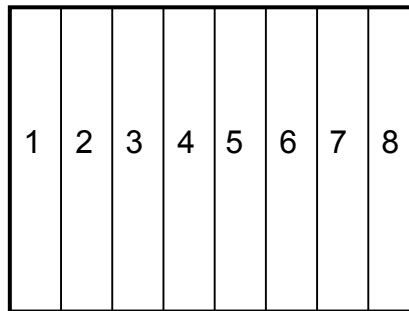

5. Optical Characteristics

5.1 Test Conditions

It is same as 4.1

The measuring method is shown in 11.

5.2 Optical Specifications

Item	Symbol	Conditions	Specifications			Unit	Remark	
			Min.	Typ.	Max.			
Viewing Angle	θ	$CR \geq 10$	$\phi = 180^\circ$	10	-	-	$^\circ$	
			$\phi = 0^\circ$	20	-	-	$^\circ$	
			$\phi = 90^\circ$	30	-	-	$^\circ$	
			$\phi = -90^\circ$	30	-	-	$^\circ$	
Contrast Ratio	CR	$\theta=0^\circ, \phi=0^\circ$	100	250	-	-		
Response Time	t_{ON}	$\theta=0^\circ, \phi=0^\circ$	-	-	50	ms		
	t_{OFF}		-	-	50	ms		
Luminance	L	$\theta=0^\circ, \phi=0^\circ$ Gray Scale Level=L63 (White)	105	150	-	cd/m ²	$I_{FL}=5.0mA$ (rms)	
Luminance Uniformity	LUNF	$\theta=0^\circ, \phi=0^\circ$ Gray Scale Level=L63 (White)	-	-	1.82	-	Lmax / Lmin	
Chromaticity	Red	x_R	Gray Scale Level:L63 $\theta=0^\circ, \phi=0^\circ$	0.55	0.62	0.69	-	
		y_R		0.25	0.32	0.39	-	
	Green	x_G	Ditto	0.24	0.31	0.38	-	
		y_G		0.46	0.53	0.60	-	
	Blue	x_B	Ditto	0.08	0.15	0.22	-	
		y_B		0.07	0.14	0.21	-	
	White	x_W	Ditto	0.29	0.34	0.39	-	
		y_W		0.29	0.34	0.39	-	

Note 1) Refer to "11. Measuring Method".

Note 2) The above test limit must be applied for initial use. Characteristics will be shifted by long period operation, but it is not irregular phenomena. Theoretically brightness characteristics will be decreased due to CCFL degradation and color shift due to optical components change.

6. Quality

6.1 Appearance Test

6.1.1 Test Conditions

- 1) Ambient Temperature : 25±5°C
- 2) Ambient Humidity : 65±20%(RH)
- 3) Illumination : Approximately 500 lx under the fluorescent lamp
- 4) Viewing Distance : Approximately 30cm by the eyes of the inspector from the module
- 5) Inspection Angle : $\theta=0^\circ, \phi=0^\circ$

6.1.2 Specifications

Item	Description														
PCB Appearance	Pattern peeling snapping, electrically short														
	Repair portion on PCB is not covered by epoxy resin														
Soldering	Cold solder joint, lead move when pulled														
Bezel, Frame, Connectors	Distinct stain, rust or scratch														
Black and White Spots/Lines ¹⁾²⁾³⁾	<table border="1"> <thead> <tr> <th>Line width</th> <th>Length(mm)</th> <th>Acceptable count</th> </tr> </thead> <tbody> <tr> <td>$W \leq 0.05$</td> <td>-</td> <td>neglect</td> </tr> <tr> <td>$0.05 < W \leq 0.10$</td> <td>$L \leq 0.7$</td> <td rowspan="2">$n \leq 4$</td> </tr> <tr> <td>$0.05 < W \leq 0.10$</td> <td>$0.7 < L \leq 1.0$</td> </tr> <tr> <td>$0.10 < W$</td> <td>-</td> <td>²⁾</td> </tr> </tbody> </table>	Line width	Length(mm)	Acceptable count	$W \leq 0.05$	-	neglect	$0.05 < W \leq 0.10$	$L \leq 0.7$	$n \leq 4$	$0.05 < W \leq 0.10$	$0.7 < L \leq 1.0$	$0.10 < W$	-	²⁾
	Line width	Length(mm)	Acceptable count												
	$W \leq 0.05$	-	neglect												
	$0.05 < W \leq 0.10$	$L \leq 0.7$	$n \leq 4$												
	$0.05 < W \leq 0.10$	$0.7 < L \leq 1.0$													
	$0.10 < W$	-	²⁾												
	<table border="1"> <thead> <tr> <th>Average diameter(mm)</th> <th>Acceptable count/side</th> </tr> </thead> <tbody> <tr> <td>$D \leq 0.2$</td> <td>neglect</td> </tr> <tr> <td>$0.2 < D \leq 0.3$</td> <td>$n \leq 5$</td> </tr> <tr> <td>$0.3 < D \leq 0.5$</td> <td>$n \leq 2$</td> </tr> <tr> <td>$0.5 < D$</td> <td>0</td> </tr> </tbody> </table>	Average diameter(mm)	Acceptable count/side	$D \leq 0.2$	neglect	$0.2 < D \leq 0.3$	$n \leq 5$	$0.3 < D \leq 0.5$	$n \leq 2$	$0.5 < D$	0				
	Average diameter(mm)	Acceptable count/side													
	$D \leq 0.2$	neglect													
	$0.2 < D \leq 0.3$	$n \leq 5$													
$0.3 < D \leq 0.5$	$n \leq 2$														
$0.5 < D$	0														

Note 1) Inspection area should be within viewing area.

Note 2) Dusts which are bigger not less than 0.10mm ($0.1 \leq W$) shall be judged by "Average Diameter".

Average Diameter $D = (a+b)/2$

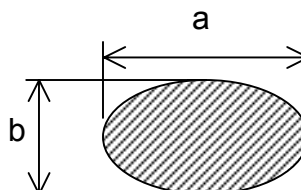

Note 3) Black and white spots/lines which can not be found by using 5%ND-Filter shall not be counted as a defect.

6.2 Display Quality

6.2.1 Test Conditions

- 1) Inspection Area : Within viewing area

- 2) Condition : Same as test conditions shown in 4.1 and 6.1.1

- 3) Test Pattern : White display pattern (gray scale level L63) and black display pattern (gray scale level L0)

6.2.2 Specifications

Item	Description / Specifications
Function	No display, Malfunction
Display Quality ¹⁾²⁾³⁾	Missing line
	Missing Sub-Pixels
	1) Bright defects : 9pcs. maximum
	2) Dark defects : 9pcs. maximum
	3) Total sub-pixel defects : 12pcs. maximum
	4) Bright defect to bright defect distance : 15mm. minimum
	5) Dark defect to dark defect distance : 15mm. minimum
	6) Bright defect to dark defect distance : 15mm. minimum
	7) Defect conjection (2sub-pixels) :2sets.maximum
	8) Defect conjection (3sub-pixels) :Nothing
	Inconspicuous flicker, crosstalk, Newton's ring and other defects : neglect
Black and White Spots/line	Inconspicuous defects : neglect
Backlight	Missing (Non-operating)

Note 1) Defects of both color filter and black matrix are counted as bright or dark defects.

Inspection area should be within the active area.

Note 2) Bright defect means a bright spot(sub-pixel) on the display pattern of gray scale L0.

Dark defect means a dark spot(sub-pixel) on the display pattern of gray scale L63.

Note 3) Bright spot which can not be found by using 5%ND-Filter shall not be counted as a defect.

6.3 Reliability Test

6.3.1 Test Conditions

- 1) The module should be driven and inspected under normal test conditions.
- 2) The module should not have condensation of water (moisture) on the module.
- 3) The module should be inspected after two or more hours storage in normal conditions (15 - 35°C,45-65%(RH)).
- 4) A module shall be used only for one test.

6.3.2 Specifications

The module shall have no failure in the following reliability test items.

Test Item	Test Conditions
High Temperature Operation ¹⁾	50°C 192 h
High Temperature Storage ²⁾	60°C 192 h
High Temperature High Humidity operation ¹⁾	50°C 80% 192 h
Low Temperature Operation ¹⁾	0°C 192 h
Low Temperature Storage ²⁾	-20°C 192 h
Temperature Shock ²⁾	-20°C ⇔ 60°C 0.5h 0.5h 50 cycles
Mechanical Vibration ²⁾	10 - 200 - 10Hz sweep/cycle, 1.5×9.8m/s ² constant, X.Y.Z each directions, 0.5h each
Mechanical Shock ²⁾	50×9.8m/s ² , 20ms, ±X, ±Y, ±Z direction, one time each

Note 1) Operating

Note 2) Non-Operating

Definitions of failure for judgment shall be as follows:

- 1) Function of the module should be maintained.
- 2) Current consumption should be smaller than the specified value.
- 3) Appearance and display quality should not have distinguished degradation.
- 4) Luminance should be larger than 50% of the minimum value.

6.4 Labels

(1) Product Label

Serial number : $\triangle\triangle$ \blacktriangle $0A$ 000001
 ① ② ③ ④

- ① : Module type code
- ② : Manufacturing code
- ③ : Lot code 0 A
 (1) (2)
 (1):Year code-end of the A.D.
 (2):Month code-alphabet
 →Jan. : A - Dec. : L
- ④ : Serial code
 decimal, 6 figures

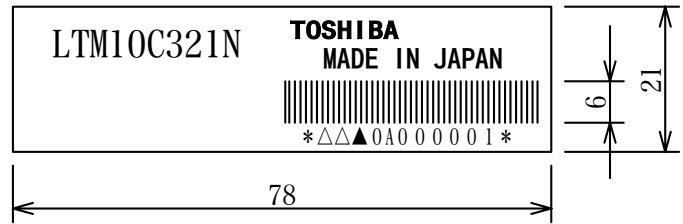

Unit : mm

(2) Caution Labels

• High Voltage

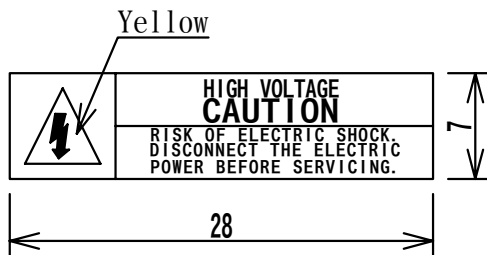

• Disposal of CCFL

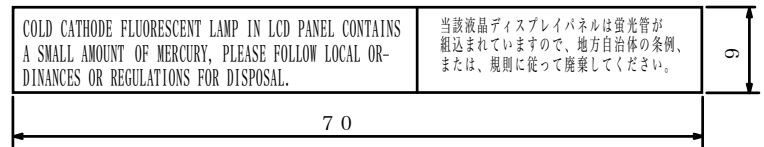

Unit : mm

(3) Label Locations

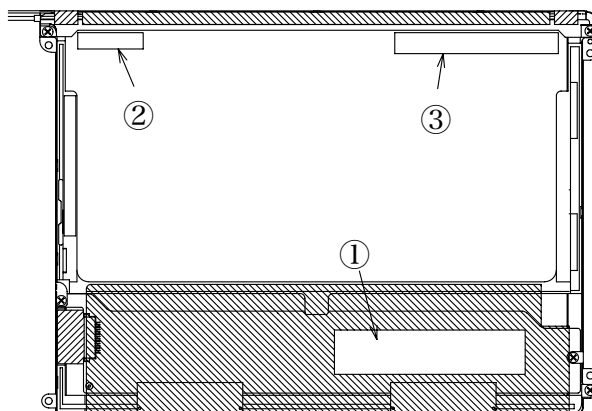

- ① Product Label
- ②③ Caution Labels

7. Lifetime

7.1 Module (except lamp)

MTTF (Mean Time To Failure) : 50,000 h

(This value is not assurance time but inference value by following conditions.)

Conditions : Ambient temperature : 25±5°C (No wind)

Ambient humidity : 65%(RH)

7.2 Lamp

7.2.1 Test Conditions

Ambient temperature : 25±5°C (No wind)

Ambient humidity : 65%(RH)

Lamp current : 5.0mA(rms)

Lighting condition : continuous lighting

Driving frequency : 50kHz

7.2.2 Specifications

MTBF : 10,000 h

Definitions of failure for judgment shall be as follows.

- 1) LCD luminance becomes half of the minimum value.
- 2) Lamp doesn't light normally.

Note1) In case of LCD long period operation, discoloration of light guide or optical sheet will be happened due to ultra violet and heat from CCFL. As the result, there is possibility to have out of specification for the optical characteristics as "4.3.2". But this is not irregular phenomena. Moreover, CCFL also has the characteristic of color shift by long period operation.

8. Packaging

8.1 Carton (internal package)

(1) Packaging Form

Corrugated cardboard box and polyethylene foam as shock absorber

(2) Packaging Method ¹⁾²⁾

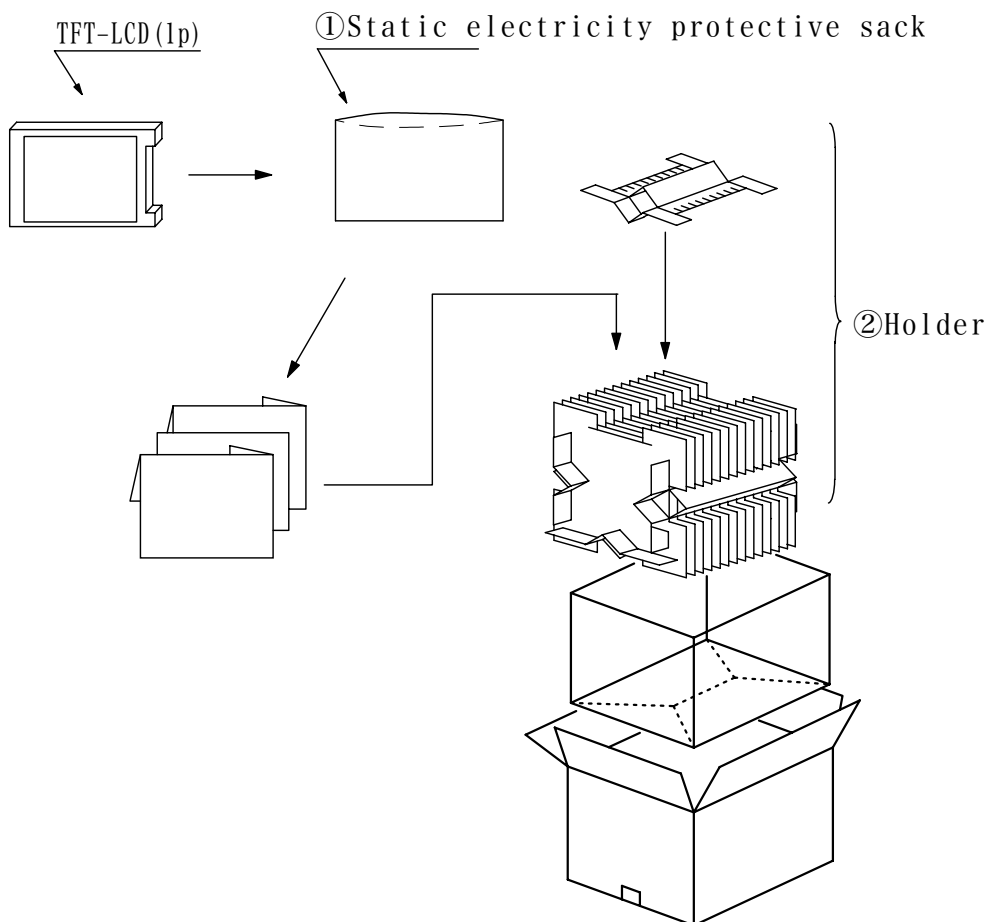

Note 1) : Acceptable number of piling : 12 sets

(3) Packaging Material

Number	Quantity	Description
①	25	Static electricity Protective sack
②	1 set	Holder(inner box)
③	-	Plastics adhesive tape

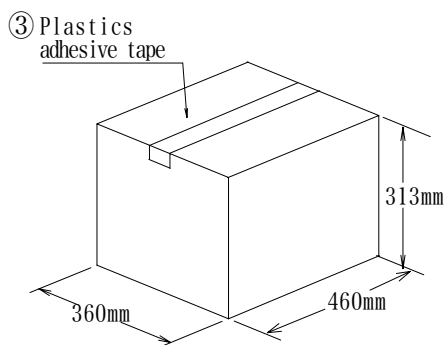

(4)Label

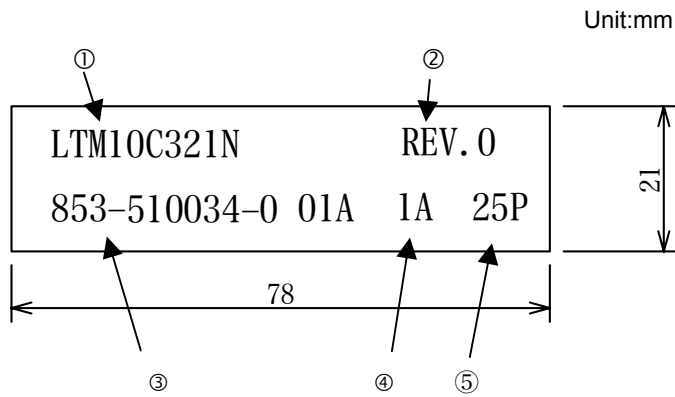

- ① : Module type name
- ② : Revision code
- ③ : NEC code
- ④ : Lot code 1 A
 - (1) (2)
 - (1):Year code-end of the A.D.
 - (2):Month code-alphabet
 - Jan. : A - Dec. : L
- ⑤ : Number of products

9. Warranty

Warranty clause will be decided separately.

10. Regulation

The set (which our LCD module is assembled into) to conform the regulations below, take measures in set side. Toshiba is not liable for the regulations to the complete set, nor can guarantee our LCD module conform the regulation by itself.

a) Examples of EMI Regulations

- FCC : PART15 CLASS B
- VCCI : CLASS B
- CISPR : CLASS B

b) Examples of Safety Regulations

- IEC 950
- UL 1950

11. Measuring Method

11.1 Measuring System

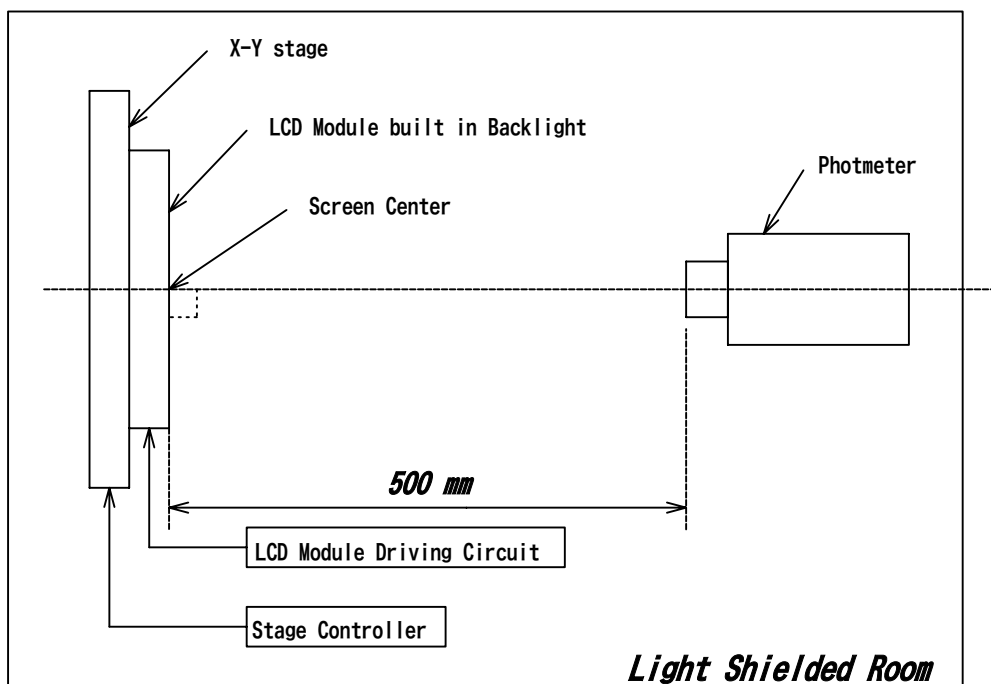

(1) The measurement point is the center of the active area except the measurement of Luminance Uniformity.

(2) Photometer : BM-7/BM-5A TOPCON (Aperture 2°)

(3) Definition of ϕ and θ :

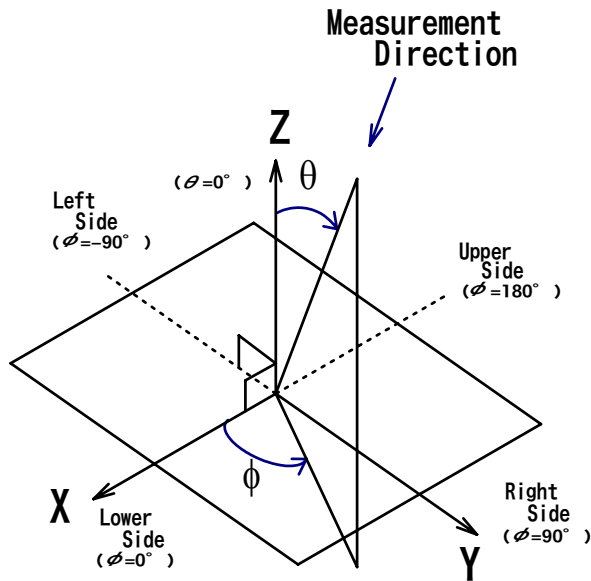

11.2 Measuring Methods

(1) Luminance:

The luminance of the center on a white raster (gray scale level L63) shall be measured.
Measurement shall be executed 30 minutes after the lamp is lit up.

(2) Contrast Ratio:

The contrast ratio can be calculated by the following expression.

$$\text{Contrast Ratio (CR)} = L63 / L0$$

L63 : Luminance on the white raster (gray scale level L63)

L 0 : Luminance on the black raster (gray scale level L0)

(3) Viewing Angle

Viewing angle is defined as the angles(θ, ϕ), in which specified contrast ratio can be obtained.
(Refer to 11.1(3) for the axes.)

(4) Luminance Uniformity:

The Luminance should be measured at 9 positions on white raster(gray scale level L63).
 Uniformity can be calculated by the following expression.

$$\text{Luminance Uniformity} = \frac{\text{Maximum Luminance}}{\text{Minimum Luminance}}$$

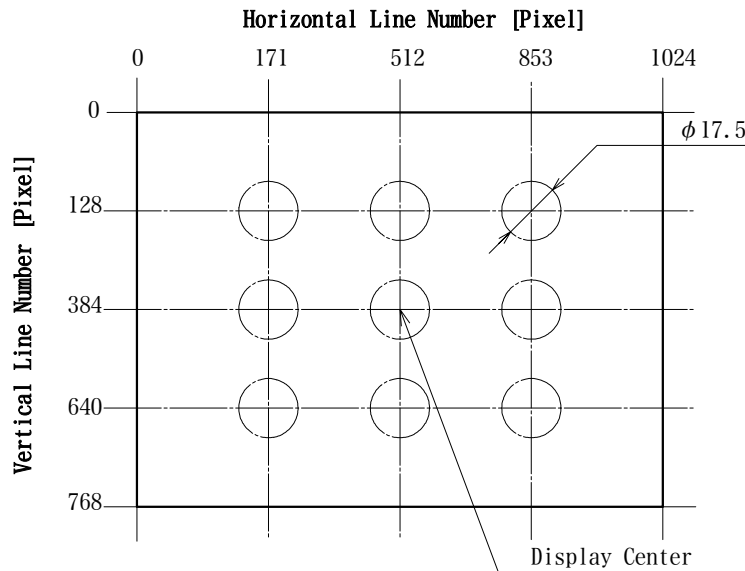

(5) Chromaticity :

The values(x,y) of chromaticity coordinates should be measured for the White, Red, Green and Blue Raster(gray scale level L63) each with a photometer.

(6) Response Time :

The response time (t_{ON} , t_{OFF}) is measured with a photo detector (photodiode) which measures the light intensity of the pixels.

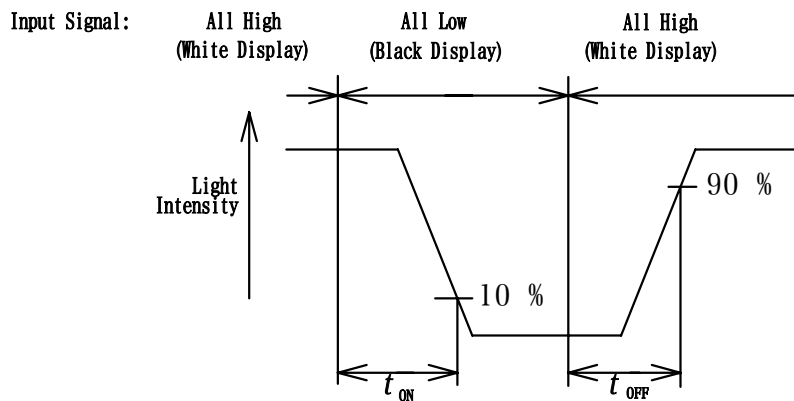

t_{ON} : Turn on time is the time for a photo detector output waveform to go from its maximum value to 10% of its maximum.

t_{OFF} : Turn off time is the time for a photo detector output waveform to go from zero to 90% of its maximum.

Photodiode : S1223-01 HAMAMATSU PHOTONICS K.K.

White Display : White Raster (gray scale level L63)

Black Display : Black Raster (gray scale level L0)